

**THE UTILITY OF RESTING LEVELS OF IGF-I AND IGFBP-3  
AS MARKERS OF TRAINING STATUS  
IN ELITE ATHLETES**

Troy K. Bischler

B.Sc. University of Lethbridge, 2005

A Thesis

Submitted to the School of Graduate Studies  
of the University of Lethbridge  
in Partial Fulfillment of the  
Requirements for the Degree of

Master of Science in Exercise Science

Department of Kinesiology  
University of Lethbridge  
LETHBRIDGE, ALBERTA, CANADA

© Troy K. Bischler, 2007

## ABSTRACT

Insulin-like growth factor-I (IGF-I) and its principle binding protein (IGFBP-3) are believed to play a role in mediating the anabolic effects of exercise. The purpose of this study was to assess the effect of 4 months of training on IGF-I and IGFBP-3, and to determine if changes in IGF-I or IGFBP-3 were related to changes in training status. Twelve varsity swimmers (5 males, 7 females) were tested pre-season, and again after 8 and 16 weeks of training. Measures included:  $VO_2$  max, nutritional status, athletic performance, subjective symptoms of overtraining, and serum levels of IGF-I and IGFBP-3. There was no significant change across time in  $VO_2$  max, athletic performance, IGF-I or IGFBP-3. Resting IGFBP-3 was positively correlated to symptoms of overtraining at week 0 ( $p=0.017$ ), however, this relationship did not persist at week 8 or 16. These findings can not confirm that resting levels of IGF-I and IGFBP-3 are sensitive markers of training status.

## ACKNOWLEDGEMENTS

The researcher would like to acknowledge and thank the following people:

- My Supervisor, Dr. Jennifer Copeland for her invaluable guidance, knowledge and support throughout the course of this work.
- Dr. Lesley Brown for her input and advice on this thesis.
- Patti White for all her help with data collection.
- All the subjects who volunteered their early mornings, hard work, and blood to this project.
- My family for their unfaltering support, encouragement and numerous care packages.
- Lindsay, for her unlimited patience and encouragement.

# TABLE OF CONTENTS

	<u>Page</u>
ABSTRACT.....	iii
ACKNOWLEDGEMENTS.....	iv
TABLE OF CONTENTS.....	v
LIST OF TABLES.....	vii
LIST OF FIGURES.....	viii
CHAPTER 1: INTRODUCTION.....	1
PURPOSE OF THE STUDY.....	7
SIGNIFICANCE.....	7
HYPOTHESES.....	8
LIMITATIONS AND DELIMITATIONS.....	8
Limitations.....	8
Delimitations.....	8
CHAPTER 2: REVIEW OF THE LITERATURE.....	9
SOMATOMEDIN HYPOTHESIS.....	11
PHYSIOLOGICAL ROLE OF THE GH/IGF-I AXIS.....	14
Growth Hormone (GH) Action.....	14
Insulin-Like Growth Factor (IGF) Action.....	15
Growth and Development.....	15
Metabolic function.....	17
Insulin-Like Growth Factor Binding Proteins (IGFBP).....	17
IGFBP Protease.....	21
IGF-I Receptors.....	21
FACTORS THAT INFLUENCE IGF-I AND IGFBP-3.....	22
Effects of Age.....	23
Effects of Body Composition.....	23
Effects of Nutrition.....	24
Effects of Exercise.....	24
IGF-I Response to Acute Exercise.....	25
IGFBP-3 Response to Acute Exercise.....	29
IGF-I Response to Exercise Training.....	31
IGFBP-3 Response to Exercise Training.....	33
RELATIONSHIP BETWEEN IGF-I AND IGFBP-3 AND MEASURES OF TRAINING STATUS.....	35
SUMMARY AND RATIONALE OF THE STUDY.....	37

CHAPTER 3: METHODOLOGY.....	39
SUBJECT RECRUITMENT AND SCREENING.....	39
EXPERIMENTAL PROCEDURES.....	39
SFMS Scores .....	41
Blood Sampling.....	42
Anthropometric data.....	42
Aerobic Power.....	43
Lactate.....	44
Heart Rate.....	44
Nutritional Assessment .....	45
Athletic Performance.....	45
BIOCHEMICAL ANALYSES.....	45
STATISTICAL ANALYSES.....	46
CHAPTER 4: RESULTS.....	47
SUBJECT CHARACTERISTICS.....	47
NUTRITIONAL STATUS.....	48
FITNESS AND ATHLETIC PERFORMANCE.....	49
RESTING GROWTH FACTOR AND BINDING PROTEIN LEVELS.....	51
CHAPTER 5: DISCUSSION.....	58
SUMMARY OF FINDINGS.....	58
FITNESS MEASURES.....	58
RESTING IGF-I AND IGFBP-3 LEVELS.....	60
TRAINING EFFECTS ON RESTING IGF-I.....	60
TRAINING EFFECTS ON RESTING IGFBP-3.....	63
RESTING IGF-I AND IGFBP-3 AND MEASURES OF TRAINING STATUS.....	65
CONCLUSION AND RECOMMENDATIONS FOR FUTURE WORK.....	66
REFERENCES.....	68
APPENDICIES	
A. Abbreviations.....	82
B. Subject forms.....	84
C. Individual hormone concentrations.....	98
D. Clinical Reference Ranges.....	102
E. Hormone Assay Procedures.....	104

## LIST OF TABLES

	<u>Page</u>
Table 1. Summary of studies examining the IGF-I response to acute aerobic exercise.....	28
Table 2. Summary of studies examining the IGF-I response to exercise training.....	33
Table 3. Summary of studies examining the IGFBP-3 response to exercise training.....	35
Table 4. Intra- and inter-assay coefficient of variations and sensitivity of assays.....	46
Table 5. Team training volumes from the beginning to the end of the study period.....	47
Table 6. Participant gender, age and years of training experience.....	47
Table 7. Individual anthropometric data.....	49
Table 8. Individual maximal exercise data.....	50
Table 9. Individual data for IGF-I and IGFBP-3 concentrations and IGF-I/IGFBP-3 ratio across testing phases.....	98
Table 10. Enzyme-linked Immunosorbent Assay procedures for analysis of serum IGF-I and IGFBP-3.....	104

## LIST OF FIGURES

	<u>Page</u>
Figure 1.	Original Somatomedin Hypothesis and the later revised Somatomedin Hypothesis.....13
Figure 2.	Proposed mechanism whereby IGFBP-3 potentiates IGF-I action.....20
Figure 3.	Schematic diagram of the experimental procedures of the study.....41
Figure 4.	VO <sub>2</sub> max protocols used for both male and female subjects.....44
Figure 5.	Individual and mean data for the relative daily calorie intake for the three days prior to each testing period.....48
Figure 6.	Individual and mean data for the relative daily protein intake for the three days prior to each testing period.....48
Figure 7.	Individual and mean data for the relative change in athletic performance across all testing phases.....50
Figure 8.	Individual and mean data for SFMS scores at all three testing phases of the study.....51
Figure 9.	Mean IGF-I concentration at the three testing phases of the study.....52
Figure 10.	Mean IGFBP-3 concentration at the three testing phases of the study.....52
Figure 11.	Mean IGF-I/IGFBP-3 ratio at the three testing phases of the study.....53
Figure 12.	Relative change in IGF-I at the three testing phases of the study.....53
Figure 13.	Relative change in IGFBP-3 at the three testing phases of the study.....54
Figure 14.	IGF-I concentrations in both male and female subjects across all three testing phases.....54

	<u>Page</u>
Figure 15. IGFBP-3 concentrations in both male and female subjects across all three testing phases.....	55
Figure 16. The relationship between IGFBP-3 and SFMS scores at pretesting, after 8 weeks and 16 weeks of training.....	56
Figure 17. The relationship between IGF-I and SFMS scores at pretesting, after 8 weeks and 16 weeks of training.....	57
Figure 18. Individual data for absolute change in IGF-I across time.....	99
Figure 19. Individual data for absolute change in IGFBP-3 across time.....	99
Figure 20. Individual data for percent change in IGF-I across time.....	101
Figure 21. Individual data for percent change in IGFBP-3 across time.....	101



# **CHAPTER 1**

## **INTRODUCTION**

The Insulin-like growth factor (IGF) system is involved in a wide range of physiological processes within the human body. IGF-I is an anabolic and mitogenic peptide that plays an essential role in the regulation of somatic growth, development and metabolic processes (Daughaday & Rotwein, 1989; Fargo & Chowen, 2005). According to the somatomedin hypothesis, the anabolic and growth-promoting effects of growth hormone (GH) are mediated through IGF-I (Eliakim, Nemet & Cooper, 2005; LeRoith, Bondy, Yakar, Liu & Butler, 2001). IGF-I is also thought to be involved in the regulation of GH production via a negative feedback with the hypothalamus (Berelowitz et al., 1981; Daughaday, 2000).

Only a small fraction (<1%) of free IGF-I exists in human circulation, and the majority (>99%) of IGF-I circulates bound to one of six binding proteins (IGFBP 1-6) (Cohick & Clemmons, 1993). More than 75% of IGF-I circulates as part of a ternary complex consisting of IGFBP-3 and an acid-labile subunit (ALS) (Baxter, 1994). IGFBP-3 is produced primarily in the liver and is believed to be regulated by GH (Blum et al., 1990; Martin & Baxter, 1992). In a study conducted by Baxter and Martin (1986) it was observed that IGFBP-3 was 80% lower in GH deficient individuals and significantly elevated in patients with excessive GH production (acromegaly).

IGFBPs play essential physiological roles within the human body. When IGF-I binds with IGFBP-3 its half-life is prolonged at least 10-fold to 15-20 hrs (Martin & Baxter, 1992), thus creating a large reservoir of circulating IGF-I (Juul et al., 1994). This

bound IGF-I may become available during certain conditions, such as physiological stress (Jones & Clemmons, 1995). IGFBP-3 also plays a critical role in regulating IGF-I bioavailability. IGFBP-3 has a higher affinity for IGF-I than does the IGF-I receptor, therefore, when IGF-I is bound to IGFBP-3 it cannot interact with the receptor (Jones & Clemmons, 1995). In contrast to this obvious inhibitory role, it is hypothesized that IGFBP-3 may also augment the action of IGF-I due to its association with specific molecules located on the cell membrane. The association with these molecules results in an increase in the local concentration of IGF-I in the vicinity of IGF-I receptors (Jones & Clemmons, 1995).

IGF-I receptors are the only receptors that specifically recognize IGF-I and are present in the majority of tissues within the body. IGF-I receptors are critical in mediating the short-term metabolic and long-term mitogenic effects of IGF-I (Cohick & Clemmons, 1993). Regulation of the IGF-I receptor is not well understood, however, it is suggested that the number of IGF-I receptors is influenced by IGF-I concentration (Poretsky, Glover, Laumas, Kalin & Dunaif, 1988).

Originally, IGF-I was thought to be primarily of hepatic origin and, therefore to function solely in an endocrine manner. Advancements in technology have led to the discovery of locally produced IGF-I, with autocrine/paracrine functions. It is believed the production of hepatic IGF-I is under the control of GH (Clemmons & Van Wyk, 1984; Daughaday & Rotwein, 1989; Deschenes, Kraemer, Maresh & Crivello, 1991), while the production of non-hepatic IGF-I appears to be less sensitive to GH concentration (Muller, Locatelli & Cocchi, 1999). It is unclear whether locally produced (non-hepatic) IGF-I

contributes to circulating levels or if it is consumed by the tissue of origin (Eliakim, Youngman & Cooper, 2000).

Circulating levels of IGF-I and IGFBP-3 show little daily variation (Gram et al., 2006), however, their concentrations can be influenced by a number of genetic and environmental factors. Both IGF-I and IGFBP-3 show a steady age-dependent effect, peaking in the pubertal years and then declining throughout adult life (Baxter & Martin, 1986; Blum & Ranke, 1991; Hall et al., 1980; Harrela et al., 1996; Juul et al., 1994). This observed decline is believed to be associated with the age-related decline in GH and possibly a decrease in GH sensitivity (Juul et al., 1994), however, this relationship is not fully understood. It is also suggested that the age related decline may be related to a decline in physical activity (Kelly et al., 1990; Poehlman & Copeland, 1990).

Nutritional status is a well-known regulator of the IGF system. Prolonged fasting in humans results in a significant decline in serum levels of IGF-I and IGFBP-3 (McCusker, Campion, Jones & Clemmons, 1989; Merimee, Zapf & Froesch, 1982; Nemet et al., 2004; Thissen, Ketelslegers & Underwood, 1994). In contrast, overfeeding leads to an increase in IGF-I levels (Forbes, Brown, Welle & Underwood, 1989). Total energy intake and protein intake are reported to have a greater impact on IGF-I levels compared to other components of diet (Cappon, Brasel, Mohan & Cooper, 1994).

The influence of body composition on the IGF system is not well documented. However, recent findings suggest that both body mass index (BMI) and percent body fat (%BF) are independent predictors of IGF-I concentration (Gomez et al., 2004; Gram et al., 2006; Poehlman & Copeland, 1990). IGF-I and IGFBP-3 appear to be positively related to BMI until a certain threshold is met (BMI = 24-26 kg/m<sup>2</sup>). When BMI

surpasses this threshold, an inverse relationship is observed (Gram et al., 2006). In addition, it was reported that male individuals who were classified as obese had lower levels of IGF-I compared to non-obese individuals (Gomez et al., 2004).

There is accumulating evidence that suggests exercise is a major regulator of both IGF-I and IGFBP-3 concentrations. Previous studies have found circulating IGF-I to be positively related to physical activity (Kelly et al., 1990; Poehlman & Copeland, 1990; Rudman, 1985), aerobic fitness (Kelly et al., 1990; Manetta et al., 2003; Poehlman & Copeland, 1990; Weltman et al., 1994) and muscular strength (Cappola, Bandeen-Roche, Wand & Fried, 2001). However, since exercise can vary widely in mode, duration and intensity, the effects of exercise on IGF-I and IGFBP-3 have been difficult to identify.

Several studies have confirmed that brief bouts of intense aerobic exercise results in transient increases in IGF-I (Bang et al., 1990; Copeland & Heggie, (in press); Dall et al., 2001; Elloumi et al., 2005; Schwarz, Brasel, Hintz, Mohan & Cooper, 1996). The mechanisms responsible for the exercise-induced increase have not been clearly established. In contrast to the observed increase, other studies have revealed no change or slightly decreased IGF-I levels following prolonged endurance exercise (Koistinen, Koistinen, Selenius, Yikorkala, Seppala, 1996; Suikkari et al., 1989; Wilson & Horowitz, 1987). It is believed that an exercise-induced decrease in IGF-I may reflect energy availability. Prolonged exercise (2-3 hours) can lead to an energy deficient state and depleted glycogen stores and previous work has confirmed that energy deficiency can lead to a decrease in circulating IGF-I (Nemet et al., 2004; Smith, Clemmons, Underwood, BenEzra & McMurray 1987). A number of other factors such as exercise

intensity, training status and subject age may also influence exercise-induced energy deficiency and subsequent decline in IGF-I concentration.

Acute exercise may also have transient effects on circulating levels of IGFBP-3. Studies have found IGFBP-3 to increase following acute exercise (Chadan et al., 1999; Copeland & Heggie, (in press); Schwarz et al., 1996). The findings from both Schwarz et al. (1996) and Copeland and Heggie (in press) suggest the IGFBP-3 response may be intensity dependent. Conversely, other studies have found no change or a decrease in IGFBP-3 concentration following acute exercise (Koistinen et al., 1996). Similar to IGF-I, it is speculated that exercise duration may have a significant influence on the IGFBP-3 response to acute exercise.

Findings from a recent study suggest that a relationship between training status and IGFBP-3 concentration exists. Elloumi et al. (2005) reported that fatigued and potentially overtrained athletes, as estimated by scores on an overtraining questionnaire, present a decrease in IGFBP-3 level in response to acute exercise. Elloumi et al. (2005) did not provide any physical measures of training status or a longitudinal examination of this potential relationship. Confirming and understanding the relationship between training status and IGFBP-3 may help in developing an effective tool for diagnosing overtraining training syndrome (OTS).

The effect of long-term training on the IGF-I system is not well understood. Some studies have indicated an increase in resting IGF-I following exercise training (Chicharro et al., 2001; Koziris et al., 1999; Poehlman, Rosen and Copeland, 1994; Roelen et al., 1997), while others have reported a decrease (Eliakim, Brasel, Mohan, Wong & Cooper, 1998; Eliakim et al., 1996; Jahreis, Kauf, Frohner & Schmidt, 1991; Rosendal et al.,

2002). The inconsistencies among results may be explained by various factors, including age, nutritional status and intensity of training. Recent findings from Rosendal et al. (2002) suggest that training experience or fitness is one factor that has a significant influence on resting IGF-I. It was found that 11-weeks of exercise training lead to decrease in resting IGF-I within the untrained subjects, where as no change in resting IGF-I was found within the trained subjects.

Long-term exercise training may also influence resting levels of IGFBP-3. Studies have found IGFBP-3 to increase in response to six-months of high volume swim training (Koziris et al., 1999) and following four months of intense cycling training (Manetta et al., 2003). In contrast, no significant change in IGFBP-3 was detected following eight weeks of endurance training (Poehlman, Rosen, and Copeland, 1994), three weeks of cycling training (Chicharro et al., 2001), and eight months of triathlon training (Maimoun et al., 2004). Moreover, IGFBP-3 has also been found to decrease in response to five weeks of exercise training (Eliakim et al., 1996; Eliakim et al., 1998) and four weeks of military training.

It has been hypothesized that the effects of exercise training on resting levels of IGFBP-3 are dependent on the relative physiological stress applied during exercise training (Rosendal et al., 2002). If the physiological stress during exercise training exceeds a certain minimum threshold, IGFBP-3 levels are expected to increase. Conversely, if the physiological stress during training exceeds a maximum threshold, IGFBP-3 levels are expected to decrease (Rosendal et al., 2002). Although the magnitude of physiological stress needed to surpass the minimum and maximum thresholds is

unique to the individual and dependent on various factors, training status appears to be highly correlated with these thresholds (Rosendal et al., 2002).

## **PURPOSE OF THE STUDY**

Numerous studies have investigated the response of IGF-I and IGFBP-3 to acute exercise, however, the response of IGF-I and IGFBP-3 to exercise training remains poorly documented. Studies have suggested that acute changes in IGF-I and IGFBP-3 can provide an indication of training status, however, this has not been examined over the course of a long-term training period. Therefore, the purpose of this study is to assess the effects of long-term exercise training on the resting levels of IGF-I and IGFBP-3 and to determine if changes in resting IGF-I or IGFBP-3 are associated with measures of training status including maximal aerobic power, athletic performance or symptoms of overtraining.

## **SIGNIFICANCE**

An understanding of how training status, and potentially overtraining, affects resting IGF-I and IGFBP-3 would assist athletic trainers, coaches and athletes in identifying optimal training volumes. Understanding this relationship could also be beneficial for elite athletes as it may allow early detection of overtraining syndrome (OTS) so that appropriate preventive measures can be taken.

## **HYPOTHESES**

1. Resting levels of IGF-I and IGFBP-3 will increase with increased fitness and athletic performance.
2. If an individual exhibits symptoms of overtraining, resting levels of IGFBP-3 will decrease.

## **LIMITATIONS AND DELIMITATIONS**

### **Limitations**

1. It was assumed that subjects completed the health screening form accurately and therefore were free from medications that could affect hormone concentration.
2. It was assumed that subjects truthfully and accurately recorded their food records and therefore accurately portrayed their nutritional status.
3. It was assumed that subjects correctly answered the SFMS questionnaire and therefore accurately portrayed their subjective training status.
4. It was assumed that subjects followed the specified pre-testing guidelines before blood samples were drawn and before fitness testing.
5. Motivation of subjects is subjective and may have varied between testing sessions.

### **Delimitations**

1. The sample was limited to 5 male and 7 females who were all members of the University of Lethbridge swim team, therefore, these results may only be generalized to young male and female varsity swimmers.



## **CHAPTER 2**

### **REVIEW OF THE LITERATURE**

The Insulin-Like Growth Factor (IGF) system plays a critical role in normal growth and development in the human body (LeRoith, Scavo & Butler, 2001a; LeRoith, Bondy, Yakar, Lui & Butler, 2001b). In addition to growth and development, the IGF system also participates in cell differentiation and survival, metabolic processes and tissue repair (Baker, Liu, Robertson & Efstratiadis, 1993; Daughaday & Rotwein, 1989; Liu, Baker, Perkins, Robertson and Efstratiadis, 1993). The IGF system consists of IGF-I and IGF-II, IGF-binding proteins (IGFBP) 1-6, acid-labile subunit (ALS), IGF receptors (IGF-R) and IGFBP protease (Butler & LeRoith, 2001).

The Insulin-like Growth Factors (IGF-I and IGF -II) are single chain polypeptide growth factors (Cohick & Clemmons, 1993). IGF-I is a 70-amino acid polypeptide, which plays a significant role in the growth of most, if not all, tissues in the body (Kraemer, 1994). IGF-II is a 67-amino acid polypeptide, which is thought to play a significant role in prenatal development, however, its physiological significance is less understood. Due to the limited knowledge surrounding the function of IGF-II and its response to exercise, this review will focus on IGF-I.

The amino acid sequence of IGF-I shares approximately 50% homology with insulin (Rinderknecht & Humbel, 1978a; Rinderknecht & Humbel 1978b). Unlike insulin, IGF-I circulates in the blood at a total concentration of 0.1  $\mu\text{mol/L}$ , which is 1000 times greater than the circulating insulin concentration (Mohan & Baylink, 1996). The liver is the primary source of IGF production and secretion (Deschenes et al., 1991),

however, it is now clearly established that IGF-I is also produced in many other tissues including bone, skeletal muscle, kidney, adipose, pancreas, and skin (Daughaday & Rotwein, 1989; D'Ercole, Applewhite & Underwood, 1980; LeRoith & Roberts, 1993; Muller et al., 1999; Van, Lund, Lee & D'Ercole, 1988). Within human muscle, two variants of IGF-I have been identified, IGF-IEa and IGF-IEc, also known as 'mechanogrowth factor' (MGF). IGF-IEa is produced in muscle and is thought to play a role in upregulating protein synthesis. It is believed that IGF-IEa is similar to hepatic IGF-I in that it has an endocrine function (Goldspink & Harridge, 2004). MGF is thought to be regulated by physical activity and, unlike IGF-IEa, MGF is potentially consumed by the muscle, indicating a paracrine action (Goldspink & Harridge, 2004). The role of these muscle-produced growth factors is not fully understood, and how much they contribute to circulating concentration of IGF-I or consumed by the muscle is unknown. Few studies have investigated the production of muscular IGF-I and other non-hepatic IGF-I because of the difficulty in quantifying their concentrations.

Growth Hormone (GH) is believed to be the major hormonal regulator of hepatic IGF-I (Clemmons & Van Wyk, 1984; Daughaday & Rotwein, 1989; Deschenes et al., 1991). Studies have shown that the administration of GH to normal healthy subjects results in a significant increase in plasma IGF-I concentrations (Copeland, Underwood & Van Wyk, 1980). Conversely, locally produced IGF-I is thought to be under the influence of different regulators depending on the tissue type (Muller et al., 1999). For example, it has been shown that in cortical bone, sex steroids, GH, and parathyroid hormones regulate IGF-I production, while in the reproductive system, IGF-I is thought to be under the influence of sex steroids (Muller et al., 1999).

The majority (more than 75%) of circulating IGF-I is bound to a 150 kDa ternary complex consisting of IGFBP-3 and an acid labile subunit (Cohick & Clemmons, 1993). IGF-I exerts its effect at the cellular level by interacting with an IGF-I receptor (IGF-IR) (Cohick & Clemmons, 1993). Originally it was thought IGF-I interacted with IGF receptors solely in an endocrine manner, however, it is now recognized that locally produced IGF-I acts in an autocrine-paracrine manner (LeRoith & Roberts, 1993).

### **SOMATOMEDIN HYPOTHESIS**

The existence of IGFs was first proposed in 1957 (Salmon & Daughaday, 1957). At that time, researchers were trying to understand the interactions between pituitary hormones and somatic growth. Salmon and Daughaday (1957) revealed that when the anterior pituitary of the rat was surgically removed (hypophysectomy) a reduction in the incorporation of sulfate ( $\text{SO}_4$ ) into chondroitin sulfate of epiphyseal cartilage resulted. When these same rats were treated with bovine growth hormone (bGH) the incorporation of sulfate into cartilage was greatly renewed, however, when bGH was injected into cartilage prepared in vitro, minimal results were observed. These findings illustrated that GH alone does not stimulate growth directly, but rather it acts indirectly through a serum factor.

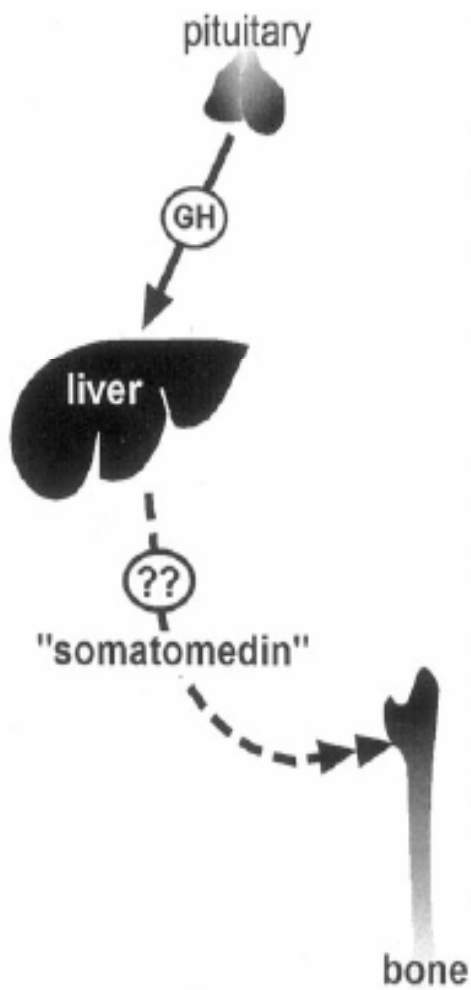
Due to its ability to stimulate the uptake of sulfate into epiphyseal cartilage, this newly discovered serum factor was labeled sulfation factor (LeRoith et al., 2001b). However, in the 1970's, sulfation factor was renamed to somatomedin to reflect its ability to mediate the effects of GH (Daughaday et al., 1972; Jones & Clemmons, 1995). After the establishment of its primary amino acid sequence (Rinderknecht & Humbel, 1978a;

Rinderknecht & Humbel 1978b), and the discovery of its ability to stimulate glucose uptake into fat and muscle cells (Froesch et al., 1976; Rinderknecht & Humbel, 1978a), the somatomedins were renamed to insulin-like growth factor-I and II.

At the time of discovery, different hypotheses were developed to model the growth promoting actions of IGF-I, however, the somatomedin hypothesis was the most widely accepted (LeRoith et al., 2001b). The original somatomedin hypothesis proposed that GH secreted from the anterior pituitary stimulated the production and secretion of IGF-I from the liver (Fig. 1) and then, via endocrine action, IGF-I would stimulate epiphyseal plate cartilage and longitudinal bone growth (LeRoith et al., 2001b).

This original somatomedin hypothesis was challenged when D'Ercole et al. (1980) found that IGF-I was produced and released by many other tissues in the body, not solely the liver. From their findings it was suggested that IGF-I had an autocrine-paracrine function as well as the classic endocrine function (LeRoith et al., 2001a). Also challenging the original hypothesis was the work by Berelowitz et al. (1981), who found that circulating IGF-I acted on the anterior pituitary via a negative feedback loop, therefore, regulating the release of GH. These new findings led to a revision of the original somatomedin hypothesis (Fig. 1).

### Original Somatomedin Hypothesis (1950's)



### Revised Somatomedin Hypothesis (1980's)

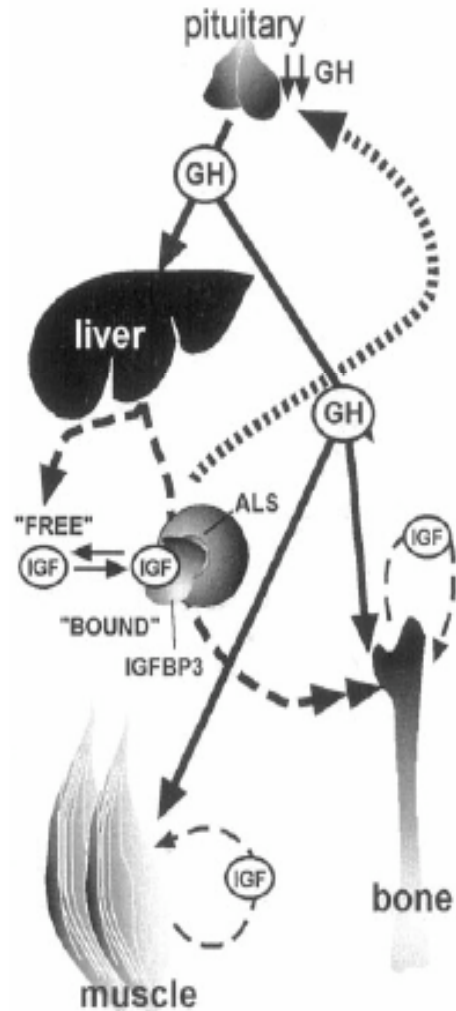


Figure 1. Original Somatomedin Hypothesis and the later revised Somatomedin Hypothesis. (Adopted from LeRoith et al. (2001b), with permission).

## **PHYSIOLOGICAL ROLE OF THE GH/IGF AXIS**

### **Growth Hormone (GH) Action**

Evans and colleagues discovered GH in 1921 when they found that extract from the anterior pituitary promoted physical growth and maturation (Fargo & Chowen, 2005). GH is a peptide hormone synthesized in the anterior pituitary, which is regulated by two neuropeptide hormones from the hypothalamus. Growth hormone-releasing hormone (GHRH) stimulates GH release and somatostatin (SS) inhibits GH release (Daughaday, 2000; Fargo & Chowen, 2005). GH is secreted in a pulsatile manner, with 6 to 8 bursts per day (Borst, Millard & Lowenthal, 1994). The highest plasma concentration of GH is detected during the rapid eye movement (REM) phase of the sleep cycle, with elevations also observed 3 to 4 hours after a meal (Corpas, Harman & Blackman, 1994). The lowest levels of plasma GH occur in the morning (Corpas et al., 1994).

The name “growth hormone” was coined due to its stimulation of physical growth of the body (Friedl, 1994). GH has been shown to play a role in the growth of bone, connective, adipose, visceral and muscle tissue (Hedge, Colby & Goodman, 1987). It is interesting to note that GH effects occur primarily postnatally and is not considered to be critical in prenatal growth. In support, Laron (1993) reported that infants diagnosed with GH deficiency (GHD) or GH receptor deficiencies are born of normal stature. In addition to its function in stimulating growth, GH is also thought to have a metabolic function, including the maintenance of blood glucose, protein synthesis and lipid metabolism (Fargo & Chowen, 2005; Muller et al. 1999).

IGF-I has long been regarded as the mediator of the effects of GH (Wang, Zhou, Cheng, Kopchick & Bondy, 2004) and whether or not GH can act independently of IGF-I

has been greatly debated. More evidence is now suggesting GH does have IGF-I independent effects on somatic growth (Hunziker, Wagner & Zapf, 1994; Ohlsson, Nilsson, Isaksson & Lindahl, 1992; Ueland, 2005). Wang et al. (2004) found that long bone growth in rats was more profoundly affected in the absence of GH (no GH and decreased IGF-I) compared to the absence of IGF-I (no IGF-I but elevated GH), therefore, suggesting that GH may have a direct effect on longitudinal bone growth. Although some studies suggest that GH has direct effects, more research is needed to confirm this theory.

### **Insulin-like Growth Factor (IGF) Action**

IGF-I is polypeptide hormone that regulates cell growth and development as well as cell replication and differentiation (Jones & Clemmons, 1995). The actions of IGF-I are mediated primarily by interactions with type I IGF receptors (IGF-IR). IGF-I circulates bound to a family of six binding proteins, which is believed to regulate its endocrine actions (Paye & Forsten-Williams, 2006). IGF-I receptors are expressed on the majority of tissues in the body, thus indicating the widespread importance of IGF-I (LeRoith, Werner, Beitner Johnson & Roberts, 1995).

### **Growth and Development**

Proliferation (mitogenesis) and differentiation (myogenesis) are complex processes that are influenced by a number of mitogenic growth factors. The majority of growth factors stimulate proliferation, but inhibit differentiation. IGF-I is unique among growth factors as it stimulates both proliferation and differentiation in skeletal-muscle cells (Quinn, Steinmetz, Mass, Ong & Kaleko, 1994). The role of IGF-I in the promotion

of proliferation and differentiation has been extensively reviewed by Florini and colleagues (Florini et al., 1984; Florini, Ewton & Coolican, 1996).

IGF-I's involvement in skeletal-muscle growth and development is most strikingly demonstrated within studies using animal lines lacking the components of IGF system (knockout experiments). Mice lacking IGF-I expression and/or IGF-I receptors are significantly smaller than their littermates and experience severe muscular dystrophy and the majority die immediately following birth (Lui, Baker, Perkins, Robertson and Efstratiadis, 1993; Powell-Braxton et al., 1993). It is believed that IGF-I plays a critical role in the expression of a muscle cell-specific transcription factor, myogenin. In support of this theory, mice lacking the expression of myogenin are also born with severe muscular dystrophy (Florini et al., 1996). Studies have also demonstrated that transgenic mice over-expressing IGF-I have enhanced muscle and bone growth (Levinovitz, Jennische, Oldfors, Edwall & Norstedt, 1992; Mathews et al., 1988). To further demonstrate the significance of IGF-I on growth, it has been shown that the administration of IGF-I to growth deficient mice, leads to increase in body weight and length (Gillespie, Read, Bagley & Ballard, 1990).

The effects of IGF-I on growth and development within humans have also been described. In cases where IGF-I is significantly decreased as in GH deficiency (GHD), physical growth is suppressed. In contrast, elevated levels of IGF-I as in acromegaly, results in excessive growth (Baxter & Martin, 1986; Blum et al., 1990). The effects of IGF-I on human growth and development are also apparent during puberty. A relationship is seen during the peripubertal period when both IGF-I (LeRoith & Roberts,



1993; Bennett, Wahner, Riggs & Hintz, 1984; Cohick & Clemmons, 1993), and physical growth are significantly elevated.

### Metabolic Function

Besides playing critical roles in physical growth and development, IGF-I also exhibits a metabolic function. Since IGF-I is structurally homologous to insulin and can interact with the insulin-receptor (IR), it is not surprising that IGF-I has the potential to influence glucose metabolism (Hussain et al., 1993). Interestingly, IGF-I circulates in the body at a concentration 1000 times greater than insulin (Daughaday & Rotwein, 1989), therefore, IGF-I could theoretically contribute 50 times more insulin-like activity than insulin itself (Mohan & Baylink, 1996). Fortunately, this does not occur because the insulin-activity of IGF-I is largely neutralized as a consequence of binding to the IGF-BPs (Mohan & Baylink, 1996).

Guler, Zapf and Froesch (1987) were the first to confirm the metabolic actions of IGF-I in healthy human subjects. They found that a single intravenous injection of IGF-I induced a rapid onset of hypoglycemia. Turkalj, Keller, Ninnis, Vosmeer and Stauffacher (1992) indicated similar findings, but also concluded that the insulin-like actions of IGF-I were dose dependent, thus, as the dose of IGF-I increased, so did the rate of glucose metabolism. The Insulin-like effects of IGF-I have also been detected in patients diagnosed with chronic illness, such as type I & II diabetes (Holt, Simpson & Sonksen, 2003), and Laron dwarfism (Laron, Klinger, Erster & Anin, 1988).

### **Insulin-like Growth Factor Binding Proteins (IGFBP)**

Zapf and colleagues were the first to discover the existence of IGFBPs (Zapf, Waldvogel & Froesch, 1975). Today, six structurally distinct high-affinity IGFBPs (1-6)

have been identified (Mohan & Baylink, 2002). Of these six binding proteins, IGFBP-3 is the most abundant in human serum (Ferry, Katz, Grimberg, Cohen & Weinzimer, 1999; Martin & Baxter, 1992). Approximately 75% of IGF-I circulates as part of a larger ternary complex, which consists of IGFBP-3 and a non-IGF binding component termed acid-labile subunit (ALS) (Jones and Clemmons, 1995). The majority of IGFBP-3 and ALS is produced in the liver, however, IGFBP-3 is also produced in a number of other tissues including skeletal muscle, the spleen, heart and prostate (Baxter, 1994; Mohan & Baylink, 2002).

It is proposed that along with IGF-I, IGFBP-3 production is also under hormonal control, most notably by GH, however, the mechanism by which GH stimulates IGFBP-3 production is still under investigation. In a study conducted by Baxter and Martin (1986) it was observed that IGFBP-3 was 80% lower in GH deficient patients and was later observed to be significantly elevated in acromegalic patients. Studies have also indicated other factors such as glucocorticoids (Conover, Clarkson & Bale, 1995), estradiol (Huynh, Yang & Pollak, 1996), insulin (Suikkari et al., 1988), and prostaglandins (DiBattista, Dore, Morin & Abribat, 1996) may influence IGFBP-3 production.

A common function among binding proteins in general is to regulate ligand activity by prolonging its half-life (Mohan & Baylink, 2002). When an IGF-I binds with an IGFBP-3 and an ALS, its half-life is prolonged at least 10-fold (15-20 hrs) (Martin & Baxter, 1992), thus creating a large reservoir of IGF-I. These IGF-complexes remain in circulation because IGF cannot cross the vascular endothelial barrier without being reduced back to its free form (Binoux & Hossenlopp, 1988; Rajaram, Baylink & Mohan, 1997; Zapf, 1995). The exact function of the large stores of IGF-I is unknown, however,

it is hypothesized that this bound IGF-I can be made available during certain physiological conditions such as stress (Jones & Clemmons, 1995).

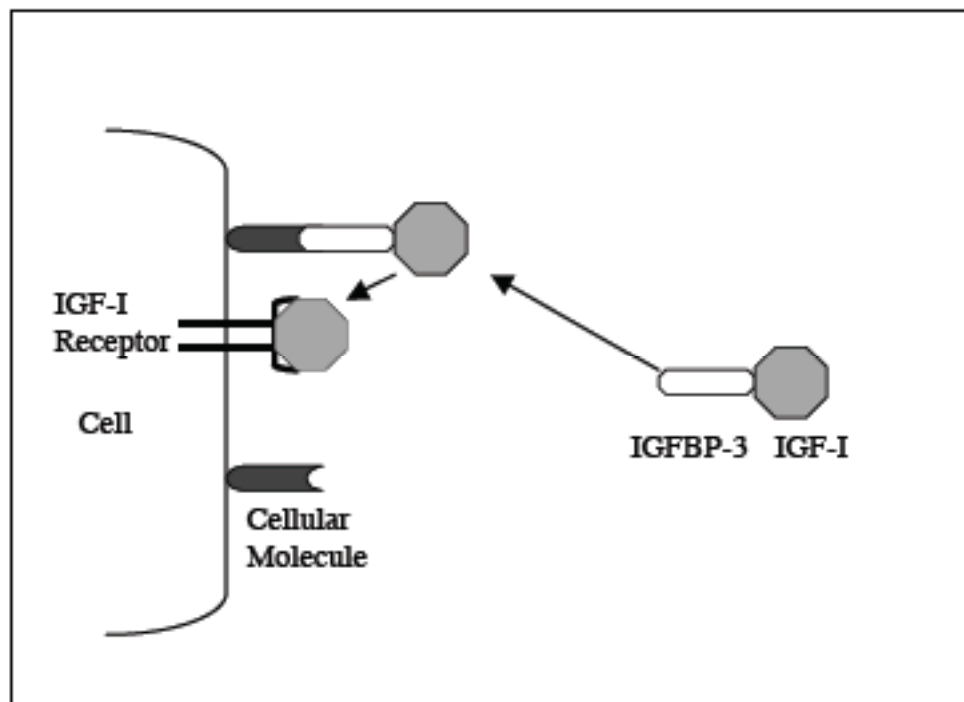
IGFBP-3 also plays a critical role in the regulation of IGF-I bioavailability, which is the amount of IGF-I available to promote its biological action (Chadan et al., 1999). In serum, IGFBP-3 has a higher affinity for IGF-I than does the IGF-I receptor, therefore, inhibiting receptor interaction (Jones & Clemmons, 1995). Without receptor interaction, the metabolic (Zapf et al., 1979) and growth promoting actions (Gillespie et al., 1990; DeMello & Baxter, 1988) of IGF-I are inhibited. More recent evidence has shown that IGFBP-3 can also express inhibitory effects independently of IGF-I. It has been demonstrated that IGFBP-3 alone can inhibit the growth of breast cancer cells (Oh, Muller, Lamson & Rosenfeld, 1993) and prostate cancer cells (Silha et al., 2006), however, the mechanisms behind these actions are not fully understood.

In contrast to its inhibitory role, IGFBP-3 has been shown to augment the action of IGF-I. Evidence of this action is apparent during the growth period of childhood and puberty. During this time serum IGFBP-3 significantly increases, showing a positive correlation with growth activity (Baxter, 1994). Moreover, it is also reported that the growth restoration by GH therapy in GH deficiency is accompanied by an increase in IGFBP-3 (Baxter, 1994). Research findings have also associated IGFBP-3 with accelerated wound healing, tissue regeneration and bone growth (Hamon, Hunt & Spencer, 1993; Mohan, 1994).

One proposed mechanism whereby IGFBP-3 potentiates IGF-I action is based on its association with specific molecules located on the cell membrane. The association with these molecules results in an increase in the local concentration of IGF-I in the

vicinity of IGF-I receptors (Jones & Clemmons, 1995). The binding of the IGFBP-3 to a surface molecule causes a decreased affinity for IGF-I, resulting in its release. This now free IGF-I is able to bind with the IGF-I receptor, thus, its mitogenic and metabolic actions can be expressed. Figure 2 illustrates the proposed mechanism whereby IGFBP-3 potentiates IGF-I action.

In summary, the exact role of IGFBP-3 is yet to be determined. It is clear that IGFBP-3 plays a key role in regulating IGF-I action by inhibiting receptor interaction. Conversely, IGFBP-3 may also promote the actions of IGF-I by prolonging its half-life and transporting it closer to the IGF-I receptors. The role IGFBP-3 is likely dependent on a number of factors including the developmental stage and/or physiological condition of the individual.



**Fig. 2. Proposed mechanism whereby IGFBP-3 potentiates IGF-I action (Adopted from Jones & Clemmons, 1995, with permission).**

### **IGFBP-Protease**

As indicated in the preceding section, IGF-I must be released from its binding protein in order to cross the endothelial barrier of the blood vessel and interact with an IGF-I receptor. Several mechanisms have been shown to facilitate this process, however, proteolytic cleavage via IGFBP-protease is the only method demonstrated for all IGFBPs (1-6). Thus, IGFBP-protease is considered to be the predominate mechanism that serves to increase IGF-I bioavailability (Bunn & Fowlkes, 2003; Frystyk, 2004).

IGFBP-protease are a group of proteolytic enzymes that are capable of cleaving IGFBPs into smaller fragments with lower affinity for IGF-I, resulting in a reduced ability to inhibit IGF-I action (Blat, Villaudy & Binoux, 1994; Katz, Rosenfeld & Cohen, 1995). Although IGFBP-protease activity may occur in the normal state (Lalou & Binoux, 1993), it is considerably greater during physiological stress, such as pregnancy, severe illness and exercise (Davenport et al., 1990; Giudice, Farrell, Pham, Lamson & Rosenfeld, 1990; Hossenlopp et al., 1990; Jones & Clemmons, 1995).

### **IGF-I Receptors**

Most of the biological actions of IGF-I are mediated by the IGF-I receptor (Fargo & Chowen, 2005; Werner et al., 1991). IGF-I receptors have been detected in a wide variety of tissues and cell lines and are the only receptor to specifically recognize IGF-I (Cohick & Clemmons, 1993; Jones & Clemmons, 1995). Structurally, the IGF-I receptor shares a high degree of homology (~70%) with the insulin receptor (Fargo & Chowen, 2005). It is not surprising that the IGF-I receptor will bind with insulin at supraphysiological concentrations, although its affinity for insulin is approximately 100-

to 500-fold lower compared to IGF-I (Werner et al., 1991). The IGF-receptor will also bind with IGF-II, but once again its affinity is significantly reduced (Werner et al., 1991).

IGF-I receptors are capable of mediating short-term metabolic, long-term mitogenic and antiapoptotic effects (Cohick & Clemmons, 1993), however, the mechanisms behind these processes are complex and not entirely understood. It is proposed that the binding of IGF-I with the IGF-I receptor causes the autophosphorylation of the receptor, which in turn leads to an interaction with cellular substrates, most notably insulin receptor substrate-I (IRS-I) (Fargo & Chowen, 2005). This interaction then mediates the transmission of mitogenic and metabolic signals to the cell nucleus (Cohick & Clemmons, 1993; Fargo & Chowen, 2005).

Research on animal and in-vitro models has indicated that regulation of the IGF-I receptor appears to be dependent on the concentration of IGF-I (Poretsky et al., 1988). Downregulation, a decrease in receptor number with increased IGF-I concentration, has been detected in a number of these models (LeRoith & Roberts, 1993). Conversely, upregulation, an increase in receptor number with a decrease in IGF-I concentration, has also been confirmed (LeRoith & Roberts, 1993). Although the biological significance of these processes is unclear, they may regulate the expression of IGF-I action when fluctuations in circulating IGF-I or IGFbps occur.

### **FACTORS INFLUENCING IGF-I AND IGFBP-3**

Circulating levels of IGF-I and IGFBP-3 are remarkably stable. No obvious daily variations have been observed (Blum & Ranke, 1991; Gram et al., 2006; Hall & Sara, 1984), however, serum levels are influenced by various factors.

### **Effects of Age**

Serum levels of IGF-I and IGFBP-3 exhibit a considerable age-dependent pattern. At birth serum levels are low but gradually increase during childhood, before peaking in the pubertal years (Hall et al., 1980). The temporary peak observed at the onset of puberty occurs almost 2 years earlier in females than in males, paralleling their normal pubertal development (Blum & Ranke, 1991). In adulthood, levels continuously decline with increasing age (Baxter & Martin, 1986; Hall et al., 1980; Harrela et al., 1996; Juul et al., 1994). In old age, serum levels are reported to be as low as those at birth (Hall & Sara, 1984). It is believed that the decrease in IGF-I and IGFBP-3 levels are secondary to an age-dependent decrease in GH production and or GH sensitivity (Hall & Sara, 1984; Juul et al., 1994). Alternatively, others suggest that the age-related decline in serum IGF-I is related to lifestyle change such as a decline in physical fitness (Kelly et al., 1990; Poehlman & Copeland, 1990).

### **Effects of Body Composition**

The relationship of IGF-I and IGFBP-3 with body composition is not well understood. Since adiposity has been shown to be inversely related to GH secretion (Rasmussen et al., 1995) and GH stimulates the hepatic production of IGF-I and IGFBP-3, circulating levels of IGF-I and IGFBP-3 are expected to be low in obese subjects. However, studies investigating IGF-I and IGFBP-3 levels in obese subjects have produced conflicting results. Recently, Gram et al. (2006) reported a nonlinear relationship between IGF-I and body mass index (BMI), which is in support of previous findings (Lukanova et al., 2002; Lukanova et al., 2004). The highest levels of IGF-I were found at a BMI between 24.6-26.6 kg/m<sup>2</sup>, while the lowest levels were detected in the

extreme categories of BMI. A positive relationship between IGFBP-3 and obesity has also been reported, however, when adjusted for waist to hip ratio (WHR), significance was lost (Gram et al., 2006).

### **Effects of Nutrition**

Nutritional status is a well-established regulator of the IGF-I system. Prolonged dietary restriction has been shown to significantly decrease serum IGF-I (Clemmons et al., 1981; Eliakim et al., 2005; Nemet et al., 2004; Smith et al., 1987) and IGFBP-3 (Axelsson et al., 2006; Frystyk et al., 2003; Thissen et al., 1994). It is unanimous among researchers that protein and calorie intake have the greatest effects on IGF-I and IGFBP-3 levels when compared to other components of the diet.

Low levels of IGF-I and IGFBP-3 are not due to decreased GH concentration since GH secretion is increased during caloric restriction (Thissen et al., 1994).

Alternatively, it is hypothesized that fasted individuals develop GH resistance and therefore have decreased hepatic IGF-I production (Gram et al., 2006; Thissen et al., 1994).

In contrast to the effects of prolonged fasting, a significant increase in IGF-I occurs during prolonged overfeeding. Forbes et al. (1989) observed that 21 days of overfeeding caused a significant increase in serum IGF-I. It is thought that the increase in IGF-I level following overfeeding reflects an increase in insulin concentration (Thissen et al., 1994).

### **Effects of Exercise**

Exercise is an important regulator of both IGF-I and IGFBP-3 concentrations. IGF-I has been shown to be positively related to physical activity (Kelly et al., 1990;



Poehlman & Copeland, 1990; Rudman, 1985), aerobic fitness (Kelly et al., 1990; Manetta et al., 2003; Poehlman & Copeland, 1990) and muscular strength (Cappola et al., 2001). However, since exercise can vary widely in mode, duration and intensity, the effects of acute exercise and exercise training on IGF-I and IGFBP-3 have been difficult to identify.

#### IGF-I Response to Acute Exercise

Acute bouts of aerobic exercise result in transient increases in circulating IGF-I. Increases have been observed following 30 minutes of moderate-intensity exercise (Bang et al., 1990), 20 minutes of continuous and intermittent exercise (Copeland & Heggie, in press), 10 minutes of exercise below and above the lactate threshold (Schwarz et al., 1996), and following a maximal test to exhaustion (Dall et al., 2001; Elias et al 2000). Currently, the mechanism responsible for exercise-induced increases in IGF-I is unknown. It is possible that the exercise-induced increase in IGF-I reflects an increase in the production of hepatic IGF-I as a result of an exercise-induced increase in GH (Eliakim et al., 2005). As discussed previously, GH is the major hormonal regulator of IGF-I, however, more recent findings suggest that exercise-induced increase in IGF-I is independent of circulating GH (Schwarz et al., 1996). It was found that GH increased only after high-intensity exercise, although IGF-I increased in both high and low intensities (Schwarz et al., 1996). In addition, other studies have reported increases in GH after endurance exercise with no subsequent increase in IGF-I (Wilson & Horowitz, 1987).

It has also been proposed that the exercise-induced increase in IGF-I is due to an increased influx from locally produced IGF-I (Brahm, Piehl-Aulin, Saltin, B & Ljunghall, 1997; Dall et al., 2001). The production and release of IGF-I from exercising muscle has

been reported (Brahm et al., 1997), however, it is unknown if non-hepatic IGF-I contributes to circulating levels. Eliakim et al. (2000) found that when blood was simultaneously collected from the basilic vein of both an exercising and a resting arm, a bilateral increase in IGF-I was detected in both arms, which suggests exercising muscle was not the only source of the increase in circulating IGF-I.

Hemoconcentration may also be in part responsible for exercise-induced increases in IGF-I (Cappon et al., 1994; Dall et al., 2001; Eliakim et al., 2000). It is acknowledged that exercise can induce a rapid decrease in plasma volume. If this decrease in plasma volume is not corrected for, an increase in IGF-I concentration may be detected, although no absolute increase in IGF-I occurred (Dill & Costill, 1974). Dall et al. (2001) reported an increase in IGF-I concentration in response to high intensity exercise, however, when corrected for plasma volume, no significant change in IGF-I was found.

While the above studies all demonstrate an increase in IGF-I in response to exercise, other studies have revealed no change or slightly decreased IGF-I levels after acute bouts of endurance exercise (Kanaley et al., 2005; Koistinen et al., 1996; Smith, Clemmons, Underwood, BenEzra & McMurray, 1987; Suikkari et al., 1989; Wilson & Horowitz, 1987). Table 1 provides a summary of studies that have investigated the IGF-I response to acute bouts of endurance exercise.

The variation among findings suggests that the IGF-I response to acute exercise is influenced by a multitude of factors. Exercise intensity is one factor that may have an influence on IGF-I. Several studies have found that acute bouts of intense exercise does result in increased IGF-I level (Elloumi et al., 2005; Schwarz et al., 1996), while studies utilizing lower intensities have found no significant increase in circulating IGF-I

(Kanaley et al., 2005; Wilson & Horowitz, 1987). Thus, it is possible that an intensity threshold must be met in order to stimulate an increase in circulating IGF-I. However, in contrast to this apparent trend, Schwarz et al., (1996) found an increase in IGF-I at low intensity exercise, which was similar to high-intensity exercise. This inconsistent finding further confirms that multiple factors influence the IGF-I response to acute exercise.

Exercise duration also appears to impact the IGF-I response. It has been acknowledged that when the energetic cost exceeds energy consumption, IGF-I levels decrease (Koistinen et al., 1996; Nemet et al., 2004; Suikkari et al., 1989). It is believed that during prolonged exercise, glucose stores become depleted and therefore glycogenolysis and glucose transport have to be downregulated in the exercising muscle and liver. At the same time liver production of IGF-I is thought to decrease because of the insulin-like effects of IGF-I on the blood glucose concentration (Steinacker, Lormes, Reissnecker & Liu, 2004). In agreement, previous investigations have found that IGF-I concentration declines in response to an energy deficient state (Smith et al., 1987). Although it is possible that the prolonged exercise duration in the studies conducted by Koistinen and Suikkari may have led to a decrease in IGF-I, it is noted that a combination of factors such as training status, age and nutritional status may have also had a significant influence on the decline in IGF-I concentration.

**Table 1. Summary of studies examining the IGF-I response to acute aerobic exercise.**

<b>Study</b>	<b>Subjects</b>	<b>Protocol</b>	<b>IGF-I Response</b>
Bang et al., 1990	3 untrained males 3 untrained females	-30 minutes of continuous cycling (60% of VO <sub>2</sub> max)	-Increased after 10 minutes of exercise.
Copeland & Heggie, (in press)	10 physically active males	-20 minutes of cycling (60-65% VO <sub>2</sub> max) -20 minutes of interval exercise (80-85% VO <sub>2</sub> max)	-Increased with both exercise protocols
Dall et al., 2001	8 female rowers 8 male rowers	-4x5 minutes of submax rowing -10 minutes rest -6 minute max rowing test	-No change during exercise -Decreased post-exercise.
Elloumi et al., 2005	11 elite male rugby players	-1.5 hours match	-Increase
Kanaley et al., 2005	8 untrained males	45 minutes of continuous cycling (60% of VO <sub>2</sub> max)	-No change
Koistinen et al., 1996	15 females 10 male Amateur runners	Marathon	-Decrease
Schwarz et al., 1996	10 untrained males	10 minutes of continuous cycling at either a high or low intensity	-Increased at both intensities
Suikkari et al., 1989	11 healthy men	3 hours of continuous cycling (45-55% of VO <sub>2</sub> max).	-No change
Wilson et al., 1987	28 children	-15 minutes of continuous cycling (60% above resting HR)	-No change

### IGFBP-3 Response To Acute Exercise

It is clear from the preceding discussion that acute exercise has an effect on circulating IGF-I. Since the majority of circulating IGF-I is complexed with and regulated by IGFBP-3, it is not surprising that exercise may also influence circulating IGFBP-3. Schwarz et al. (1996) found IGFBP-3 to significantly increase in response to both 10 minutes of high and low-intensity cycling, however, greater increases were detected after high-intensity exercise. Copeland and Heggie (in press) also found increases in IGFBP-3 after 20 minutes of continuous and interval exercise. Similar to Schwarz et al. (1996), a greater increase was reported after the more intense intermittent exercise, thus suggesting the possibility of an intensity-dependent response pattern.

The mechanism behind the exercise-induced increase in IGFBP-3 has been extensively debated. GH is considered to be the primary regulator of IGFBP-3 (Baxter & Martin, 1986; Blum, Albertsson-Wikland, Roseberg & Ranke, 1993), therefore, it is reasonable to suggest that an exercise-induced increase in GH would increase IGFBP-3 concentration. However, more recent findings suggest that exercise-induced increase in IGFBP-3 is GH-independent (Dall et al., 2001; Schwarz et al., 1996). Alternatively, it has been hypothesized that the exercise-induced increase in IGFBP-3 is regulated by IGF-I (Kanety, Karasik, Klinger, Silbergeld & Laron, 1993). Koistinen et al. (1996) reported a positive correlation between IGF-I and IGFBP-3 in response to acute exercise. However, others have found exercise-induced increases in IGFBP-3 with no increase in IGF-I (Chadan et al., 1999).

An exercise-induced increase in IGFBP-3 may also be linked to a shift in blood volume. During exercise, a shift in blood volume from regions with high IGFBP-3

concentration (i.e. liver) to the peripheral circulation is believed to occur (Koistinen et al., 1996). Others have suggested that along with a shift in blood volume, an increased influx of IGFBP-3 into the plasma, decreased IGFBP-3 clearance, and changes in plasma volume itself may also contribute to changes in circulating IGFBP-3 during exercise (Dill & Costill, 1974).

In contrast to the reported increase in IGFBP-3 in response to acute exercise, Koistinen et al. (1996) found IGFBP-3 to remain unchanged immediately following prolonged exercise. When blood samples were analysed 24-hours post-exercise, IGFBP-3 had significantly decreased compared to pre-race levels. Since previous work has confirmed the activation of IGFBP-3 proteolysis during physiological stress such as exercise (Jones & Clemmons, 1995; Rosendal et al., 2002), it is reasonable to suspect that the enhanced IGFBP-3 proteolysis led to the drop in IGFBP-3. However, since Koistinen et al., (1996) reported that no significant proteolysis had taken place, it appears that another unknown mechanism was responsible for the decrease in IGFBP-3.

The inconsistencies among previous findings suggest that multiple factors may influence the IGFBP-3 response to acute exercise. Recently, Elloumi et al. (2005) reported that scores from an overtraining questionnaire appeared to be correlated with the IGFBP-3 response to acute exercise. It was found that more fatigued athletes, as indicated by higher overtraining scores, presented a decrease in IGFBP-3 concentration after a rugby match compared to less fatigued athletes who had increased IGFBP-3 after the match. A decrease in IGFBP-3 is hypothesized to be an important mechanism in counteracting the catabolic effects of overtraining (Elloumi et al., 2005).

### IGF-Response to Exercise Training

The effect of long-term exercise training on the IGF system is not well understood. Several studies have indicated that IGF-I levels increase following exercise training. Increases have been observed following 8 weeks of endurance training (Poehlman et al., 1994), 6 months of high volume swim training (Koziris et al., 1999), high intensity cycling twice a day for two weeks (Roelen et al., 1997), and a three-week cycling race (Chicharro et al., 2001). The mechanism responsible for the increase is unknown, however, based on the work by Zanconato et al. (1994) it is speculated that an increase in IGF-I concentration must ultimately be a result of an increase in IGF-I gene expression.

In contrast to the observed increases, other studies have found IGF-I concentration to decrease following exercise training. Decreases have been observed following 5 weeks of endurance and resistance type training in adolescent males (Eliakim et al., 1998) and females (Eliakim et al., 1996), 11 weeks of physical training in untrained subjects (Rosendal et al., 2002) and 3 days of intensive gymnastic training (Jahreis et al., 1991).

Interestingly, other studies have indicated a biphasic IGF-I response to exercise training. Schmitz, Ahmed and Yee (2002) found that after 15 weeks of resistance training IGF-I significantly decreased, which was followed by an increase to slightly above baseline levels in the following 24 weeks of training. Similar results were also found following two and four weeks of combined endurance and resistance type training (Eliakim, Nemet, Bar-Sela, Higer & Falk, 2002). It is possible that the initial onset of an exercise-training program results in hormonal adaptations suggestive of a catabolic state,

but at a certain point an anabolic rebound occurs (Eliakim et al., 1996). A summary of the studies that have investigated the IGF-I response to exercise training is provided in Table 2.

Several factors may potentially contribute to these varying results. As discussed previously, nutritional status has a profound effect on circulating levels of IGF-I. It is possible that changes in IGF-I reflect changes in nutritional status. It is believed that the onset of an exercise program may result in an energy-deficient state, in which case IGF-I will decline (Nemet et al., 2004). However, in contrast, other studies that have indicated a decrease in IGF-I following exercise training have found no change in body weight or percent fat, which suggests that an energy deficiency did not occur (Eliakim et al., 1996; Eliakim et al., 1998).

Training status is another factor that may influence resting IGF-I following exercise training. Although data is limited, it has been found that IGF-I is affected differently in trained subjects compared to untrained subjects following 11-weeks of intense exercise training (Rosendal et al., 2002). IGF-I levels in the trained group displayed a biphasic response, decreasing from 0 to four weeks and then increasing to baseline levels from 4 to 11 weeks. In the untrained subjects, IGF-I levels continuously declined from 0 to 11 weeks. From this finding it appears that training status and fitness level do influence the IGF-I response to exercise training.



**Table 2. Summary of studies examining the IGF-I response to exercise training.**

Study	Subjects	Protocol	IGF-I Response
Chicharro et al., 2001	17 elite cyclists	-3 weeks of cycling	Increase
Eliakim et al., 1996	44 female high school students	-5 weeks of aerobic training	Decrease
Eliakim et al., 1998	44 male high school students	-5 weeks of aerobic training	Decrease
Eliakim et al., 2002	12 elite handball players	-4 weeks of aerobic and resistance training	-Decrease the first 2 weeks -Increase to basal levels in the following 2 weeks
Jahreis et al., 1991	16 prepubertal female gymnasts	-3 days of mixed athletic training	Decrease
Koziris et al., 1999	19 male 9 female collegiate swimmers	-6 months of high volume swim training	Increase
Maimoun et al., 2004	7 elite triathletes	-32 weeks of training	Increase
Rosendal et al., 2002	7 untrained males 12 trained males	-11 weeks of military training	Decrease in untrained subjects -Decrease at 4 weeks, then increased to pre-training levels by 11 weeks in trained subjects

### IGFBP-3 Response to Exercise Training

The effects of exercise training on resting IGFBP-3 are poorly documented.

Studies have found intense exercise training to stimulate increases in resting IGFBP-3

(Koziris et al., 1999; Manetta et al., 2003). However, not all studies have observed an

increase in resting IGFBP-3 following exercise training (Chicharro et al., 2001; Maimoun

et al., 2004; Poehlman et al., 1994; Rosendal et al., 2002). Furthermore, studies have shown resting IGFBP-3 to decrease following five weeks of exercise training (Eliakim et al., 1996; Eliakim et al., 1998). Table 3 provides a summary of the studies that have investigated resting IGFBP-3 following exercise training.

Similar to IGF-I, numerous factors can influence the resting IGFBP-3 response to exercise training including nutritional status, age, and the frequency and type of training. It has been suggested that training status may influence resting IGFBP-3 concentration following exercise training. Rosendal et al. (2002) found that IGFBP-3 levels decreased in untrained subjects from baseline to week 4 and then returned to baseline levels in the following 4 weeks, where as no change was observed with in well trained individuals. The mechanism responsible for the decrease in the untrained subjects is believed to be a result of increase IGFBP-3 proteolysis, which has been supported by others (Jones & Clemmons, 1995; Schwarz et al., 1996). Rosendal et al. (2002) reported that the physiological stress needed to stimulate proteolytic activity is potentially correlated with the initial training status of the individual. It is believed that the 11 weeks of training was sufficient to stimulate changes in IGFBP-3 in the untrained subjects, whereas higher intensities would be needed for the same response in the trained group (Rosendal et al., 2002).

**Table 3. Summary of studies examining the IGFBP-3 response to exercise training.**

<b>Study</b>	<b>Subjects</b>	<b>Protocol</b>	<b>IGFBP-3 Response</b>
Chicharro et al., 2001	17 elite cyclists	-3 weeks of cycling	No change
Eliakim et al., 1996	44 male high school students	-5 weeks of aerobic training	Decrease
Eliakim et al., 1998	44 female high school students	-5 weeks of aerobic training	Decrease
Koziris et al., 1999	19 male swimmers 9 female swimmers	-6 months of high volume swim training	Increase
Maimoun et al., 2004	7 elite triathletes	-8 months of intense training	No change
Manetta et al., 2003	8 male cyclist 8 sedentary males	-4 month of cycling (17hours per week)	Increase
Poehlman et al., 1994	10 older males 8 older females	-2 months of cycling (3 days per week)	No change
Rosendal et al., 2002	7 untrained males 12 trained males	-11 weeks of military training	No change

### **RELATIONSHIP BETWEEN IGF-I, IGFBP-3 AND TRAINING STATUS**

Establishing optimal training volumes and monitoring athletes' training status are constant challenges for trainers, coaches and athletes themselves. Insufficient training volumes may impair results, whereas training too much can potentially lead to overtraining. Overtraining syndrome (OTS) is a severe yet common condition in many elite athletes' careers. According to Morgan et al. (1987), 65% of all endurance athletes have reported overtraining symptoms at some time in their competitive career. OTS is a complex neuroendocrine disorder that is characterized by poor sport performance despite

appropriate rest, persistent muscle soreness, inability to maintain training loads, mood disturbances, reduced catecholamine secretion, frequent illness and sleep disturbances (Hug, Mullis, Vogt, Ventura & Hoppeler, 2003).

Currently there are no consistent diagnostic parameters for detecting OTS. The most frequently used indicator for OTS is a decrease in athletic performance (Armstrong & VanHeest, 2002). The other commonly used indicator is a psychological measure, such as profile of mood state (POMS) questionnaire (McKenzie, 1999). As an individual becomes overtrained, they tend to score higher on the POMS, which indicates a negative mood state (Reitjens et al., 2005).

Although data is limited, IGF-I and IGFBP-3 may also have utility in monitoring training status and detecting OTS because of their relationships with various measurements of fitness. Cappola et al. (2001) found IGF-I to be significantly correlated with knee extensor strength in elderly women, while other studies have found IGF-I to be significantly related to  $VO_2$  max in both elderly and young men (Kelley et al., 1999; Poehlman & Copeland 1990). Manetta et al. (2003) reported a correlation between IGFBP-3 and  $VO_2$  max following four months of training in previously trained cyclists. However, it is difficult to draw conclusions about the relationship between training status and IGF-I and IGFBP-3 because of the cross-sectional design of these previous studies.

Recently, Elloumi et al. (2005) found that the IGFBP-3 response to acute exercise was inversely related to scores on a standardized overtraining questionnaire. Thus, as symptoms of overtraining increased, IGFBP-3 levels decreased. Previous studies have evaluated resting IGFBP-3 following exercise training (Koziris et al., 1999), however, there has been little work done to explore the relationships between IGFBP-3 and training

status in younger individuals engaging in long-term training. It would be beneficial to understand the effects of long-term training on IGFBP-3 levels as it may provide an effective tool for monitoring training status and the detecting the early signs of overtraining.

## **SUMMARY AND RATIONALE OF THE STUDY**

Circulating levels of IGF-I and IGFBP-3 are regulated by many factors including age, nutritional status and GH concentration. Accumulating evidence now suggests that exercise is a major regulator of the IGF system. Several studies have shown that acute bouts of intense aerobic exercise results in transient increases in IGF-I and IGFBP-3 (Bang et al., 1990; Dall et al., 2001; Elloumi et al., 2005). However, the effects of exercise training on resting IGF-I and IGFBP-3 are less definitive. Studies have indicated that exercise training can induce an increase in resting IGF-I and IGFBP-3 (Chicharro et al., 2001; Koziris et al., 1999), while others have reported decreases (Eliakim et al., 1998; Eliakim et al., 1996; Jahreis et al., 1991). Due to these inconsistent results, it is thought that a training threshold may exist that describes the physiological stress applied during exercise training. Although many factors are thought to influence an individual's threshold profile, fitness and level of training status may mediate the effect of exercise on IGF-I. The relationship between measures of training status and resting IGF-I and IGFBP-3 levels during long-term training remains poorly documented.

The primary purpose of this study was to assess the effects of exercise training on resting levels of IGF-I and IGFBP-3. Due to start date of the competitive season and the volume of training, varsity swimmers were chosen for this study. Given the number of

elite endurance sports that employ a long training season, it would be relevant to understand whether training status is related to IGF-I and IGFBP-3 concentrations. Therefore, the second purpose of this study was to determine if changes in resting IGF-I and IGFBP-3 were associated aerobic power, athletic performance, or symptoms of overtraining. An understanding of how training status, and potentially overtraining affects IGF-I and IGFBP-3 would assist athletic trainers, coaches and athletes in identifying optimal training volumes. Understanding this relationship could also be beneficial for elite athletes as it may allow early detection of OTS so that appropriate preventive measures can be taken.

## **CHAPTER 3**

### **METHODOLOGY**

#### **SUBJECT RECRUITMENT AND SCREENING**

12 Elite swimmers (5 males and 7 females) from the University of Lethbridge swim team between the ages of 18 and 25 were recruited for the study. All participation was voluntary; no material incentive was provided and subjects were free to withdraw from the study at any time. All subjects were non-smokers and free from any medications that may influence growth factor concentration or athletic performance. All female subjects recruited for the study reported that they were using an oral contraceptive. All subjects read and understood the experimental procedures and the potential risks and benefits, and written informed consent was obtained.

To ensure participant safety, all subjects completed a Physical Activity Readiness Questionnaire (PAR-Q) and a medical health questionnaire (Appendix C). The medical health questionnaire was administered to provide information about any medications that the subject was taking and relevant medical history. Prior to testing, resting heart rate and blood pressure were measured. As required by the Canadian Society of Exercise Physiology (CSEP) resting heart rate and resting blood pressure was below 100 beats per minute (bpm) and 145/95 mmHg respectively.

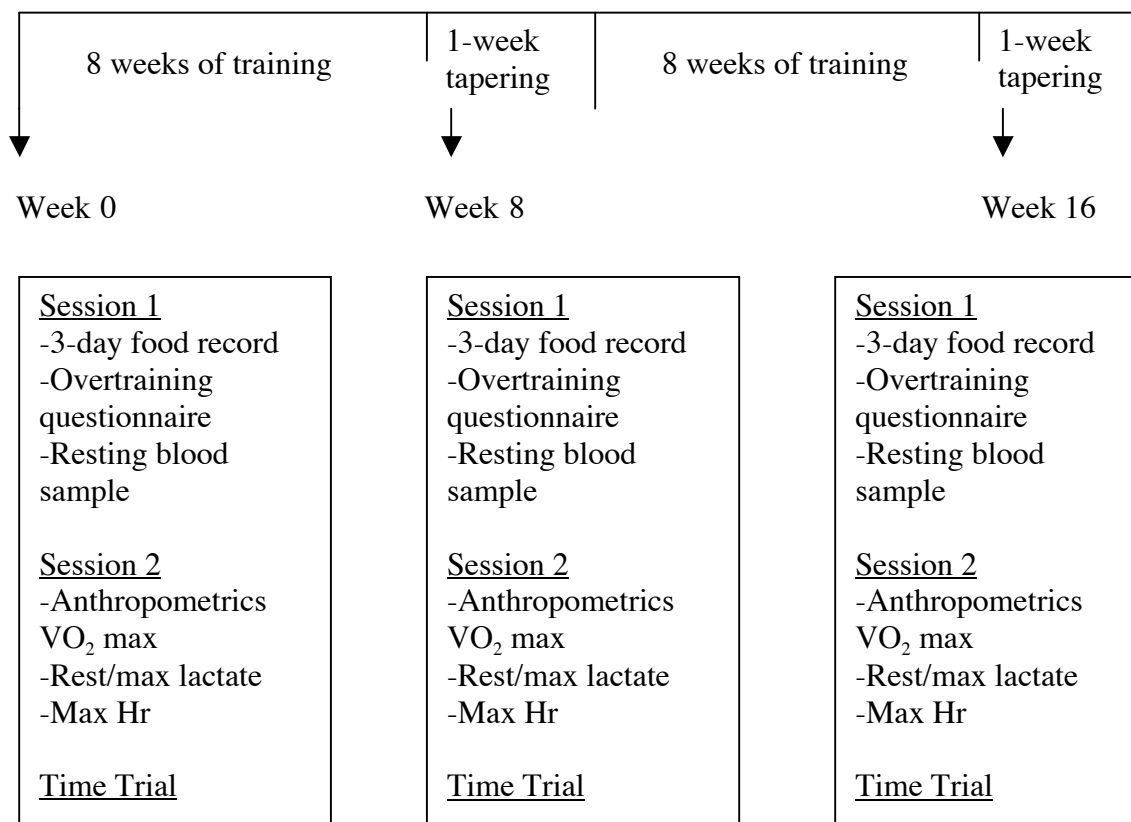
#### **EXPERIMENTAL PROCEDURES**

The study consisted of three testing phases, each using the same protocols and measurements. Initial testing took place in mid-September, which was prior to the onset

of intensive training (week 0). The second testing phase took place eight weeks after the initial testing during a one-week tapering phase (week 8). The third testing phase took place 16-weeks after initial testing during a one-week tapering phase (week 16). Figure 3 represents a schematic diagram of the experimental procedures utilized during the study.

During each phase of testing, subjects were required to attend two sessions on consecutive days at the University of Lethbridge Exercise Physiology lab. The first session involved completing a standardized overtraining questionnaire proposed by the French Society of Sports Medicine (SFMS), and the collection of a resting blood sample in order to establish serum total IGF-I and IGFBP-3 concentrations. During the second session, fitness measurements were obtained, which included anthropometric measures (skinfold measurements, height, weight), maximal aerobic fitness ( $\text{VO}_2$  max), resting and maximal blood lactate, and maximal heart rate. In addition to the data collected during the three sessions, results of a time trial for each subject in their dominant event were also obtained at each phase. The time trials were used as a measure of each subject's athletic performance throughout the study period. Subjects were also required to document their nutritional intake three days prior to the first session of each phase so that nutritional status could be monitored across each testing phase.





**Figure 3. Schematic diagram of the experimental procedures of the study**

### **SFMS Scores**

Prior to collecting resting blood samples, a standardized overtraining questionnaire developed by the French Society of Sports Medicine (SFMS) (Appendix B) was completed by each subject. Results from the questionnaire provided a SFMS score for all subjects across all three testing phases. The SFMS questionnaire was chosen for this study because of its reliability and sensitivity to changes in training status (Brun, 2003). The questionnaire was also chosen for this study because it is easy to administer and clear for participants to understand (Brun, 2003). The questionnaire consists of 54 “Yes or No” questions. The score is calculated summing the total number of yes answers.

A score equal to or greater than 20 is suggestive of overtraining (Brun, 2003; Maso, Lac & Brun, 2005).

### **Blood Sampling**

To establish resting levels of total IGF-I and IGFBP-3, blood samples were taken from each subject. A week before sampling, subjects were given strict pre-testing guidelines, which included a 12 hour fast prior to sampling and to refrain from alcohol or caffeine intake for 24 hours prior to sampling. Also, subjects were asked to refrain from strenuous physical activity for 24 hours prior to sampling. All samples were taken in a climate-controlled environment. The sampling procedures were performed between 6:30 and 8:30 am at each phase to control for any diurnal variations in growth factor levels. To assess daily variation in resting IGF-I and IGFBP-3 concentration, 75 percent of the subjects had a second sample of blood drawn the next day utilizing the same procedures. Blood samples were drawn under sterile conditions by an individual trained in phlebotomy procedures.

Approximately seven millimeters of venous blood was drawn into red top vacutainer tubes from an antecubital arm vein. The blood was then allowed to clot at room temperature for 15 minutes. The clotted samples were centrifuged at 3000 rpms, at 4°C for 15 minutes. The resulting serum was extracted and stored at -80 C until it was assayed.

### **Anthropometric Data**

The anthropometric data that were collected included height (nearest 0.5 cm), weight (nearest 0.1 kg), body mass index (BMI)(kg/m<sup>2</sup>), and percent fat, which was calculated via skinfold thickness. Skinfolds were taken according to the Jackson Pollock

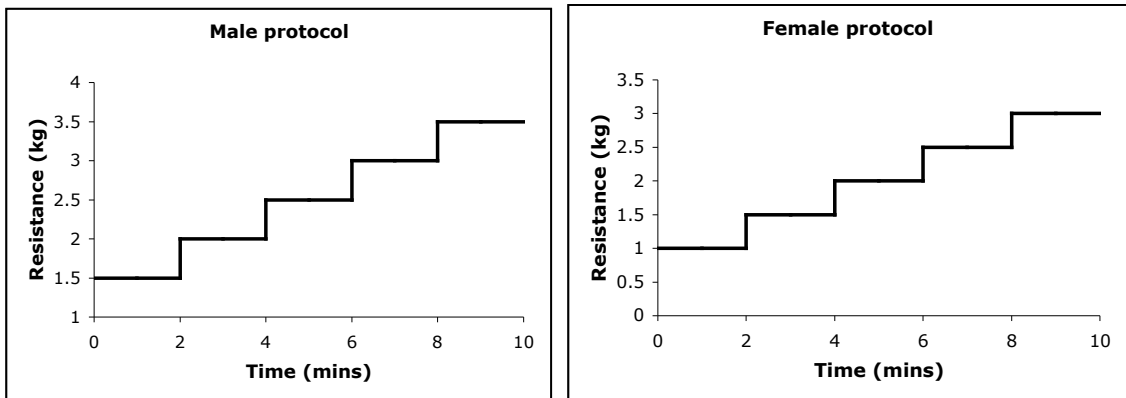
7-site method (Jackson & Pollock, 1985). All skinfold measurements were performed by the principle investigator using a Harpenden skinfold caliper.

### **Aerobic Power**

For the assessment of maximal oxygen consumptions ( $\text{VO}_2$  max), subjects performed a maximal cycle ergometer test according to the Astrand graded exercise cycle test protocol (Astrand, 1965) (Fig. 4). All  $\text{VO}_2$  max tests were performed on the Monark Ergomed 818E cycle ergometer (Monark, Varberg, Sweden). Oxygen consumption was measured using the Vista Mini CPX open-circuit spirometry system (VacuMed, Ventura, CA). Expiratory gases were analysed in 15-second averages and displayed using TurboFit 5.4 software (VacuMed, Ventura, CA). Prior to each phase of testing the cycle ergometer was calibrated for resistance, while the gas analyzers were calibrated to three standards; nitrogen, room air and a known calibration gas.

Prior to the onset of testing, subjects were introduced to the cycle ergometer and safety procedures. Subjects were also familiarized with the Borg Rating of Perceived Exertion Scale (Borg, 1982). Once the subject felt comfortable, a 5-minute warm-up followed by passive stretching was performed. Subjects were then attached to the gas collection apparatus and two minutes of resting values were obtained to ensure the system was working properly.

Subjects were instructed to maintain a pedal rate of 60 RPM throughout the entirety of the test. The male subjects started at a resistance of 1.5 kg and the female subjects started at 1.0 kg. Every two minutes the resistance was increased by 0.5 kg until exhaustion. Immediately following test termination the subject started a 5-minute active cool down.



**Figure 4. VO<sub>2</sub> max test protocols used for both males and females subjects.**

### **Lactate**

Following pre-screening, subjects were instructed to sit in a quiet and relaxed state for five minutes. A finger prick was then performed to collect a capillary blood sample. The sample was analyzed using the Lactate Pro portable lactate analyzer (Arkray Factor Inc., Shiga, Japan) to determine the pre-exercise blood lactate level. This same procedure was performed five minutes after the max VO<sub>2</sub> test in order to establish a maximal blood lactate level.

### **Heart Rate**

Both pre-exercise and maximal heart rates were obtained using a Polar telemetric heart rate monitor (Polar Electro, Kempele, Finland). The subject sat quietly for five minutes before a resting heart rate was collected. Heart rate was recorded continuously during the maximal treadmill test and following the test the data were downloaded and the maximum heart rate attained during the test was identified.

### **Nutritional Assessment**

To evaluate nutrient intake, all subjects completed a 3-day food record prior to the first session at each phase of testing. Detailed information about the procedure was explained and all subjects received three blank recording sheets (Appendix B). Subjects were instructed not to change their regular eating habits during the recording. Each subject's diet was analyzed for total caloric intake and protein consumption using Nutritionist Pro v.2.5.1 software (First Databank Inc., TX).

### **Athletic Performance**

Once during each phase of testing a time trial from each subjects dominant event was collected. The times at each phase were obtained during a competition, which took place no longer than one week following that testing phase. The time trials represented a measurement of each subject's sports-specific athletic performance.

## **BIOCHEMICAL ANALYSES**

Serum concentration of total IGF-I and IGFBP-3 were estimated using an Enzyme-Linked Immunosorbent Assay (ELISA) (Diagnostic Systems Laboratories Inc., TX.). All samples were analysed in duplicate and all samples from each subject were analysed in the same assay to minimize the effects of inter-assay variation. High and low controls were included in each assay to evaluate inter-assay variation. Table 4 reports the acceptable and average intra-assay coefficient of variation for IGF-I and IGFBP-3. Also, reported are the inter-assay coefficient of variation for both high and low controls, and the sensitivity of each assay procedure. Procedures for both IGF-I and IGFBP-3 assays are available in Appendix E.

**Table 4. Intra- and inter-assay coefficient of variations and sensitivity of assays.**

	Acceptable Intra-assay Coefficient of Variation	Average Intra-assay Coefficient of Variation	Average Inter-assay Coefficient of Variation		Sensitivity of Assay
			Low	High	
IGF-I	10%	4.2%	9.5%	4.8%	0.01 ng/mL
IGFBP-3	10%	5.3%	10.3%	3.1%	0.04 ng/mL

## STATISTICAL ANALYSIS

Descriptive data are expressed as means and standard deviations (SD). Repeated measures analysis of variance (ANOVA) was used to examine differences in variables measured at week 0, 8 and 16. If main effects were established, pairwise comparisons were conducted and adjusted for multiple comparisons (Bonferroni). Pearson product moment correlations were performed to analyze relationships between biological, physical and psychological variables. Data analysis was performed using SPSS v14 software. The significance threshold was set at  $p < 0.05$ .

## CHAPTER 4

### RESULTS

#### SUBJECT CHARACTERISTICS

All subjects attended a minimum of 85 percent of the scheduled team practices throughout the study period. Average weekly training distances (m) for each month are shown in Table 5. On average, subjects have been swimming competitively for nine years. Subject characteristics including gender, age and years of varsity training are presented in Table 6.

**Table 5. Team training volumes from the beginning to the end of the study period.**

Average Weekly Training Distance (m)				
September	October	November	December	January
14 400	19 900	25 000	22 300	21 000

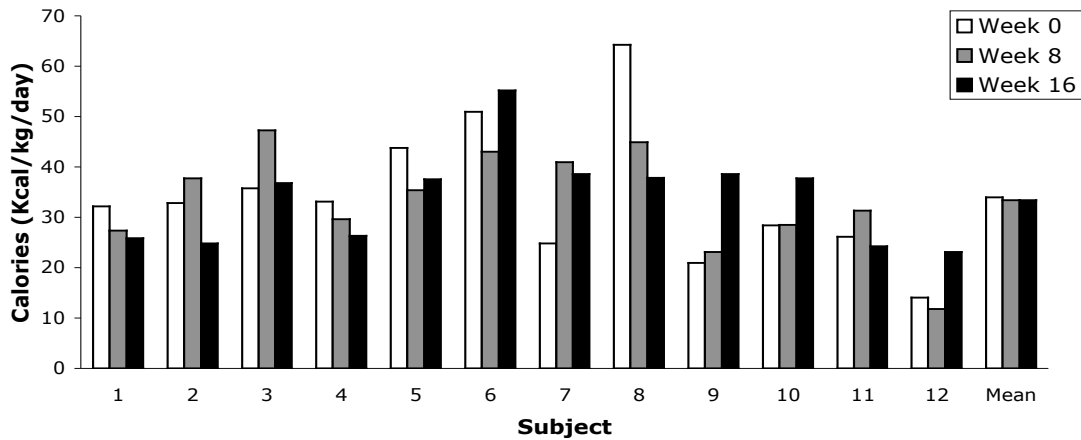
**Note:** Values are rounded to the nearest 100 m. Subjects did not train for one week in December, which was not included in the average.

**Table 6. Participant gender, age and years of training experience**

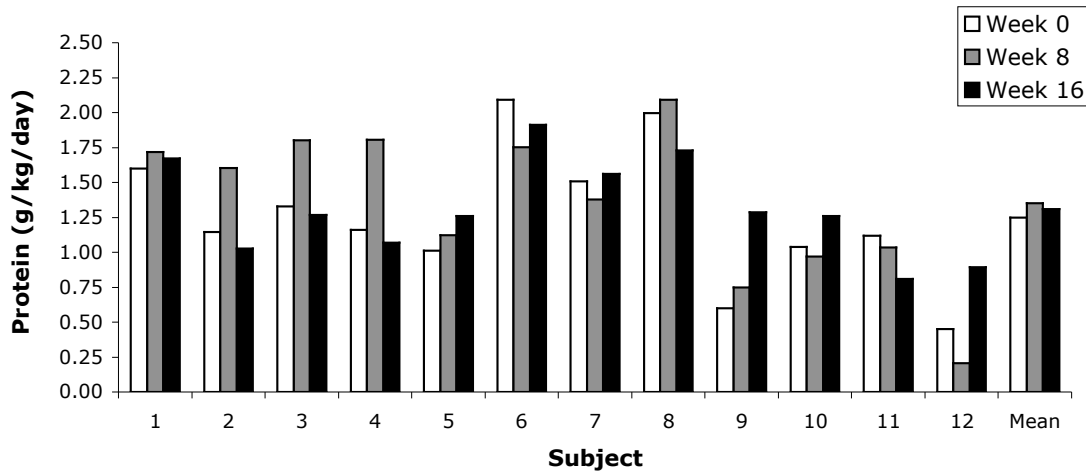
Subject	Gender	Age (Years)	Years of Varsity Training
1	M	24	3
2	M	22	5
3	M	20	2
4	M	20	2
5	M	19	3
6	F	20	3
7	F	18	1
8	F	21	3
9	F	20	1
10	F	19	2
11	F	18	1
12	F	20	4
Mean		20.1	2.5
SD±		±1.68	±1.24

## NUTRITIONAL STATUS

Figures 5 and 6 illustrate the individual and mean data for the average relative calorie and protein intake for the three days prior to testing. There was no significant difference in calorie or protein intake across the three testing phases.



**Figure 5. Individual and mean data for the average relative daily calorie intake for the three days prior to each testing period (kcal/kg/day).**



**Figure 6. Individual and mean data for the average relative daily protein intake for the three days prior to each testing period (g/kg/day).**



## FITNESS AND ATHLETIC PERFORMANCE

Table 7 presents individual anthropometric data measured at each testing phase of the study. Body fat percentage was significantly decreased at week 8 and week 16 when compared to week 0 ( $p < 0.05$ ). Changes were apparent in all other variables measured, however, statistical significance was not achieved.

**Table 7. Individual anthropometric data.**

<u>Subject</u>	<u>Gender</u>	<u>Weight (kg)</u>			<u>BMI (kg/m<sup>2</sup>)</u>			<u>Body fat (%)</u>		
		<u>Week 0</u>	<u>Week 8</u>	<u>Week 16</u>	<u>Week 0</u>	<u>Week 8</u>	<u>Week 16</u>	<u>Week 0</u>	<u>Week 8</u>	<u>Week 16</u>
1	M	76.5	75.5	76.6	23.35	23.05	23.38	11.60	9.46	11.36
2	M	107.0	107.1	107.7	34.35	34.38	34.57	21.10	18.62	19.12
3	M	68.2	67.4	67.6	19.50	19.27	19.33	8.32	6.43	7.64
4	M	69.6	72.5	72.8	22.85	23.81	23.91	9.12	10.37	9.736
5	M	69.7	73.2	72.2	20.70	21.74	21.44	10.73	12.42	11.57
6	F	51.7	51.1	51.4	18.32	18.11	18.21	11.00	9.30	8.429
7	F	74.3	70.2	72	26.17	24.73	25.35	20.09	16.57	15.85
8	F	58.2	57.7	56.6	21.00	20.81	20.4	13.08	10.02	9.84
9	F	78.0	75.2	73.8	24.34	23.47	23.03	23.93	20.72	19.30
10	F	64.7	62.1	62.8	21.37	20.51	20.74	20.78	15.87	18.34
11	F	62.7	64.5	63.9	22.48	23.13	22.91	17.57	17.92	15.64
12	F	76.0	75.3	76.6	26.45	26.21	26.66	23.48	20.44	21.74
<b>Mean</b>		71.38	70.98	71.17	23.41	23.27	23.33	15.90	14.01*	14.05*
<u>SD±</u>		13.70	13.73	13.96	4.23	4.19	4.30	5.83	4.91	4.85

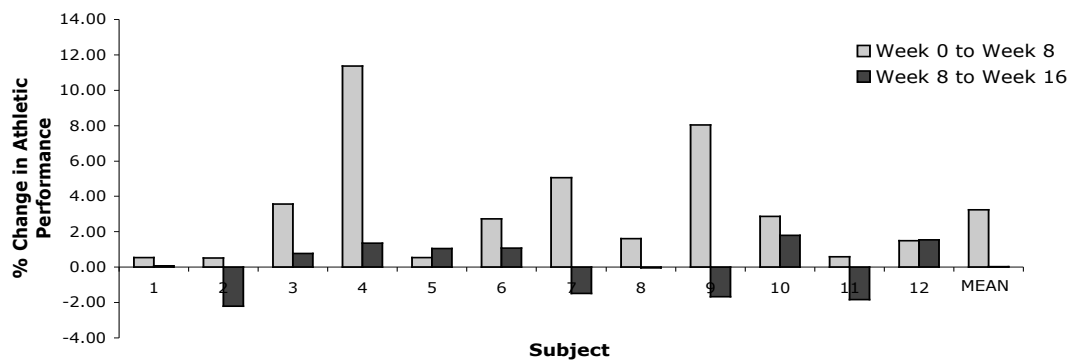
\*Significantly different from week 0,  $p < 0.05$

Table 8 presents individual maximal exercise data measured at each testing phase of the study. No significant differences were found in any of the maximal exercise variables. Figure 7 compares individual and mean athletic performance at all three testing phases. After eight weeks of training (week 0 to week 8), all subjects increased their athletic performance on average 3.24% (ranging from 0.51 to 11.36%). In the following

eight weeks of training (week 8 to week 16), eight subjects showed an improvement in athletic performance, while four subjects showed a decrease in athletic performance.

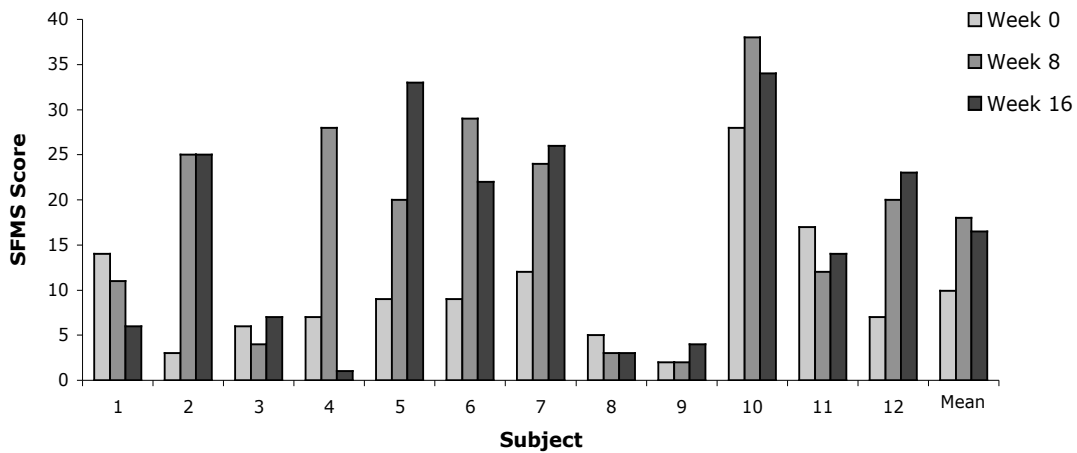
**Table 8. Individual maximal exercise data**

Subject	<u>VO<sub>2</sub> max (ml/kg/min)</u>			<u>Max HR</u>			<u>Max lactate</u>		
	<u>Week 0</u>	<u>Week 8</u>	<u>Week 16</u>	<u>Week 0</u>	<u>Week 8</u>	<u>Week 16</u>	<u>Week 0</u>	<u>Week 8</u>	<u>Week 16</u>
1	51.4	47.8	48.1	174	184	184	12.6	11.9	10.0
2	40.4	40	39.1	190	194	189	8.3	9.6	10.4
3	59.0	62.3	58.2	186	181	180	7.8	7.0	8.2
4	65.3	63.6	64.8	194	184	193	8.4	10	12.2
5	46.4	43.3	44.7	197	194	187	14.6	14.7	12.7
6	48.2	48	50	202	198	197	11.9	9.0	8.6
7	39.1	38.3	40.9	198	195	195	8.1	6.9	8.2
8	51.6	52.4	54	182	178	181	11.3	9.3	9.0
9	41.4	40.5	42	172	174	173	8.4	9.2	9.9
10	46.4	53.8	51.9	192	194	198	7.8	11.3	12.8
11	45.5	45	46.8	194	190	191	12.2	9.0	15.2
12	36.6	38.7	34.8	171	171	162	10.8	9.6	7.4
<u>Mean</u>	47.6	47.8	47.9	187.7	186.4	185.8	10.2	9.8	10.4
<u>SD±</u>	8.34	8.70	8.49	10.65	9.03	10.62	2.33	2.11	2.37



**Figure 7. Individual data for the relative change in athletic performance across all testing phases.**

Individual and mean SFMS scores at the three testing phases of the study are illustrated in Figure 8. On average, SFMS scores were elevated by 81% at week 8 and 66% at week 16 when compared week 0, which indicated greater symptoms of overtraining following 8 and 16 weeks of training. The observed changes in SFMS scores did not reach statistical significance.

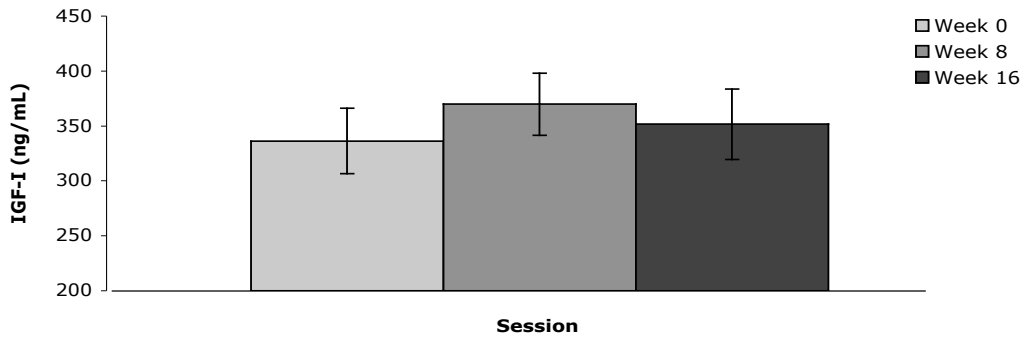


**Figure 8. Individual and mean data for SFMS scores at all three testing phases of the study.**

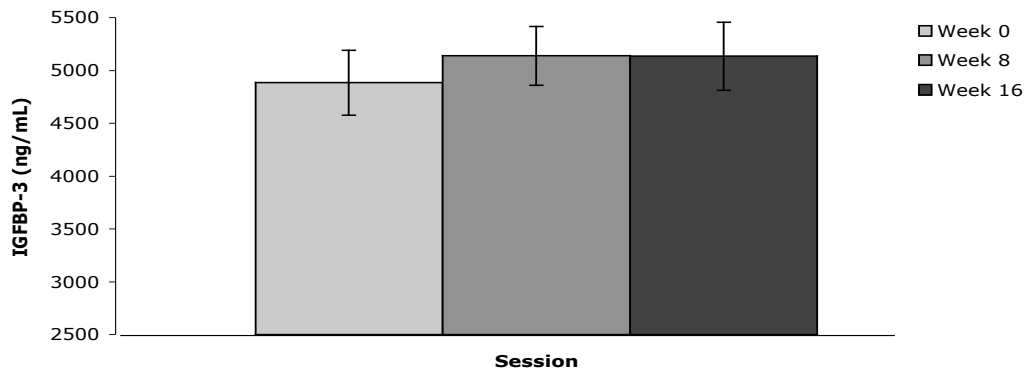
### RESTING GROWTH FACTOR AND BINDING PROTEIN LEVELS

Figures 9-11 represent the average concentration of IGF-I, IGFBP-3 and the IGF-I/IGFBP-3 ratio at each of the testing phases. There were no significant differences in IGF-I, IGFBP-3 or IGF-I/IGFBP-3 ratio across testing sessions. However, when the IGF-I data were normalized to baseline values and expressed as percent change, there was a significant difference in results from 0 to 8 weeks versus 8 to 16 weeks (Figure 12). To assess the daily variability in IGF-I and IGFBP-3 levels, two samples were collected on consecutive days for 75% of the sampling sessions. The intraclass correlation between daily IGF-I samples was 0.924 and between IGFBP-3 was 0.915, which indicates little

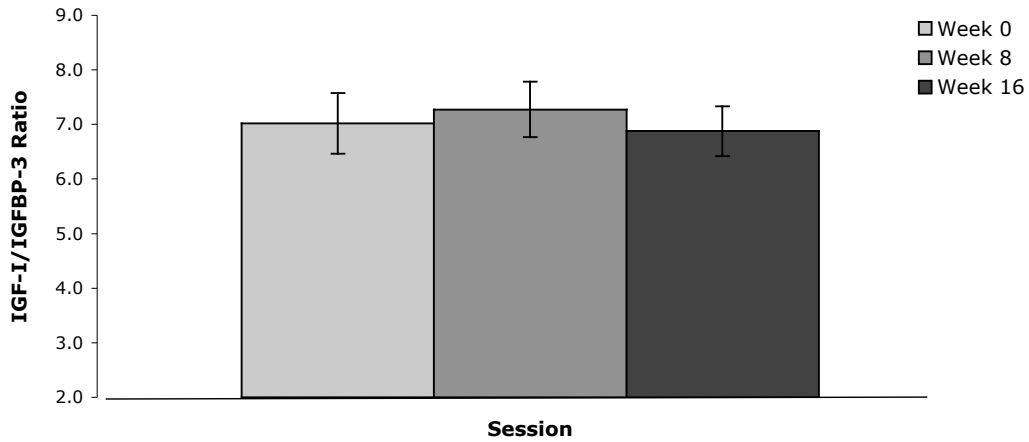
daily variation. For these samples an average of the two daily concentrations were used in the analysis and the remaining 25% of values are based on a sample from one day only. Individual results for IGF-I, IGFBP-3 and IGF-I/IGFBP-3 ratio can be seen in Appendix C.



**Figure 9. Mean IGF-I concentration at the three testing phases of the study (Mean  $\pm$  SE).**

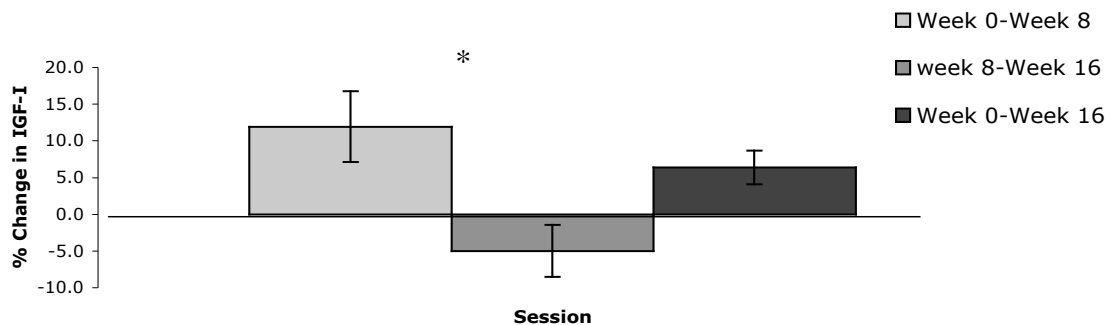


**Figure 10. Mean IGFBP-3 concentration at the three testing phases of the study (Mean  $\pm$  SE).**



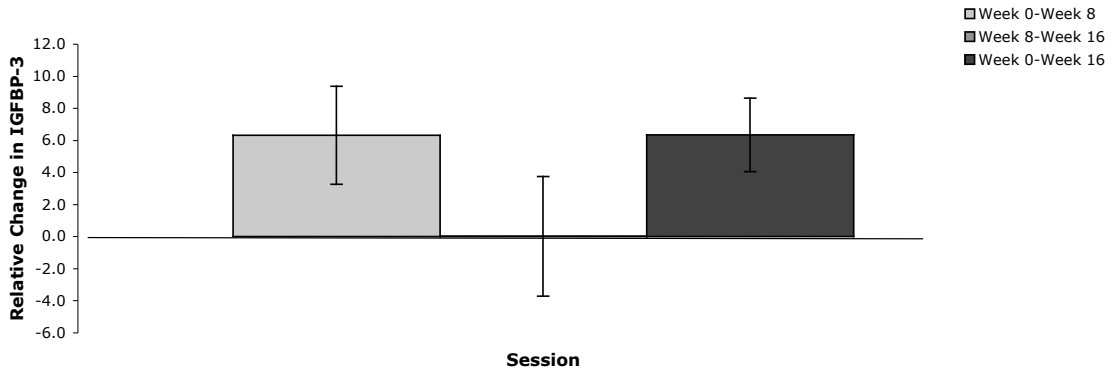
**Figure 11. Mean IGF-I/IGFBP-3 ratio at the three testing phases of the study (Mean ± SE).**

Figures 12 and 13 present the average percent change in IGF-I and IGFBP-3 between testing sessions, respectively. Results from a paired t-test revealed that the change in IGF-I concentration measured between 0 to 8 weeks (11.9%) was significantly different when compared to the change measured between 8 to 16 weeks (-4.9%) ( $p < 0.01$ ). An average 6% increase in IGFBP-3 was observed between 0 and 8 weeks, however, statistical significance was not achieved. Individual results for relative change and absolute change in IGF-I and IGFBP-3 are available in Appendix D.



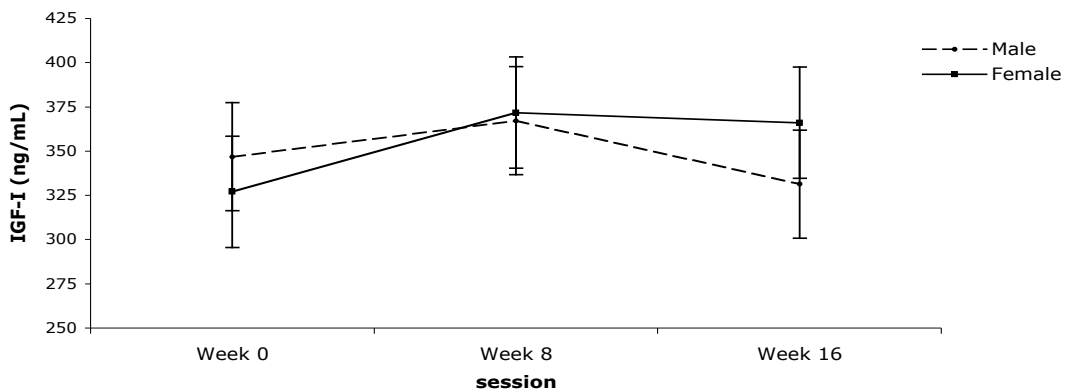
**Figure 12. Average relative change in IGF-I between all phases of the study (Mean ± SE).**

\* Significant difference in relative change in IGF-I level between 0 to 8 weeks compared to 8 to 16 weeks  $p < 0.05$ .

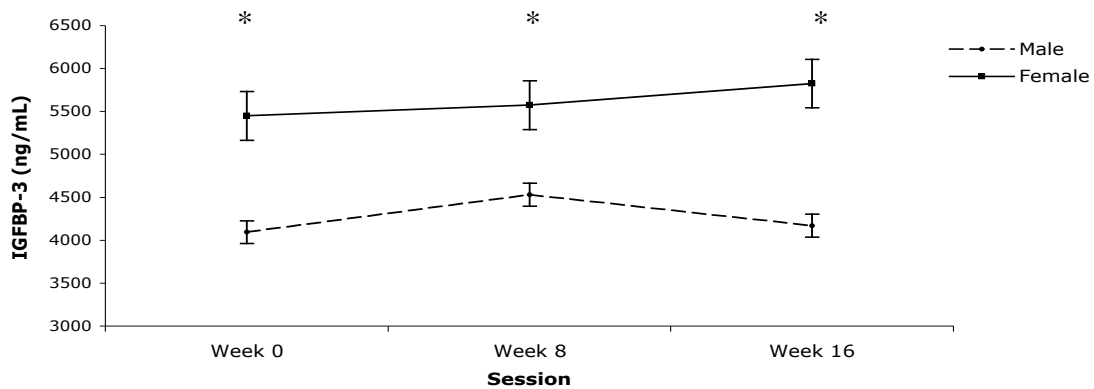


**Figure 13. Average relative change in IGFBP-3 between all phases of the study (Mean  $\pm$  SE).**

Resting IGF-I and IGFBP-3 levels in both male and female subjects at all testing phases of the study are illustrated in Figures 14 and 15, respectively. Although the purpose of the present study was not to investigate the gender differences in IGF-I and IGFBP-3 across training, an analysis between genders was necessary to justify including data from both genders into one group. Although IGFBP-3 levels were significantly greater in the female group ( $p < 0.05$ ), these figures illustrate that the changes in IGF-I and IGFBP-3 during training were similar in both genders.



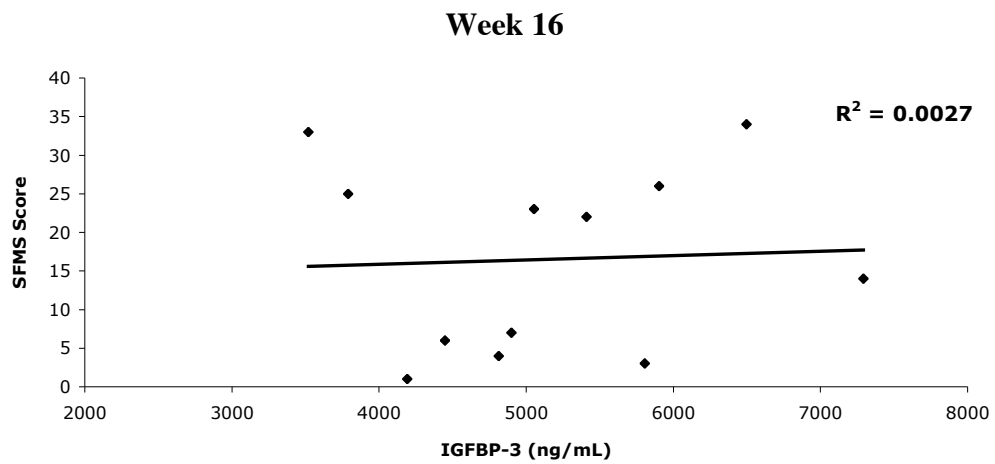
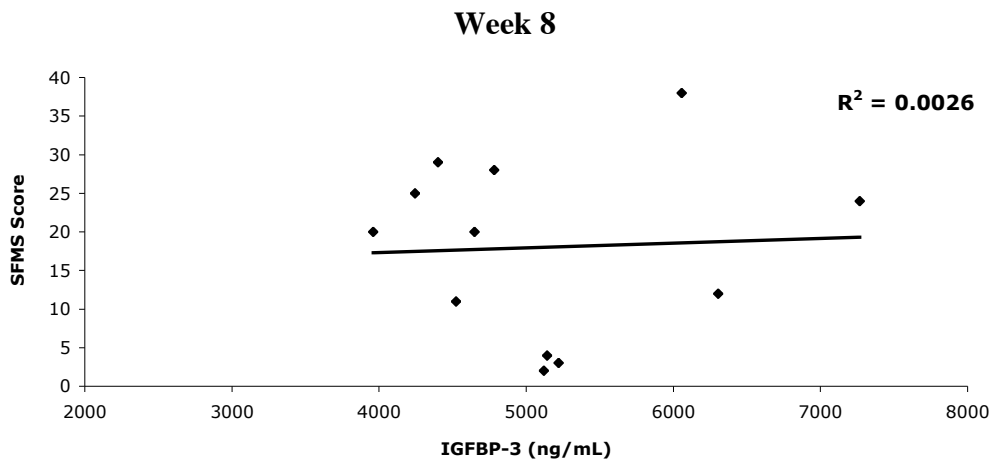
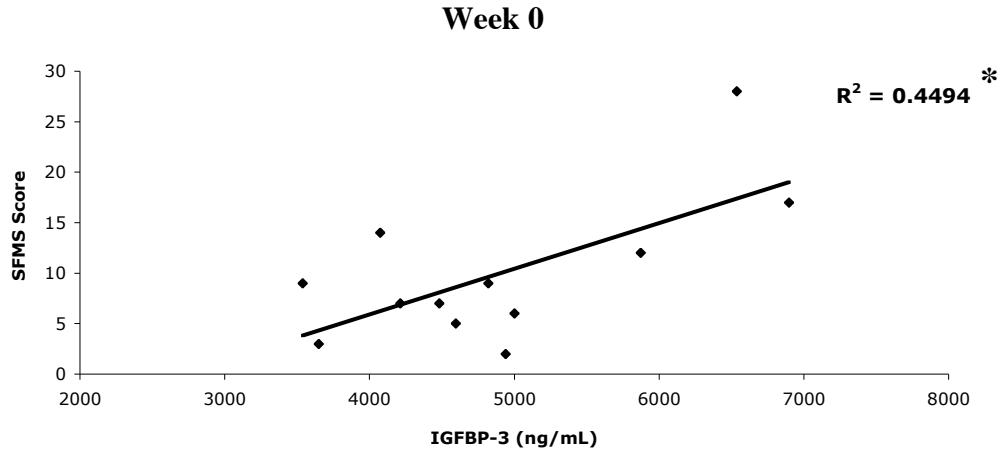
**Figure 14. IGF-I concentrations in both male and female subjects at all three testing phases (Mean  $\pm$  SE).**



**Figure 15. IGFBP-3 concentrations in both male and female subjects across all three testing phases (Mean  $\pm$  SE).**

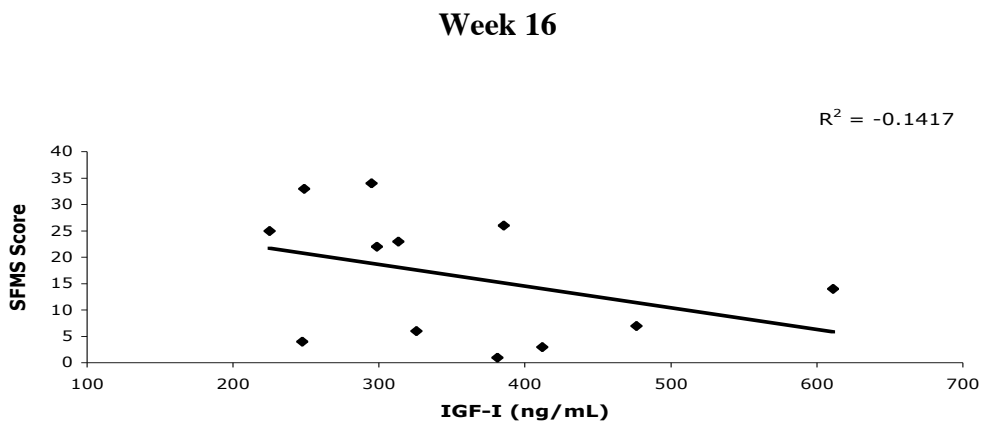
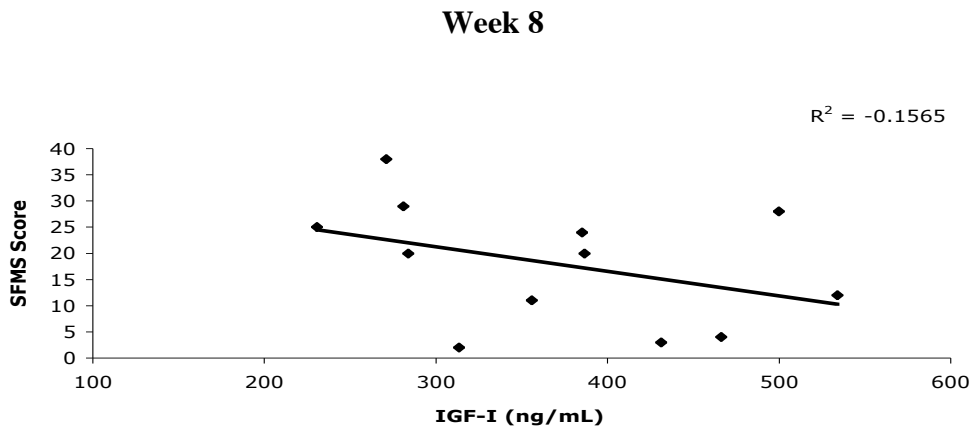
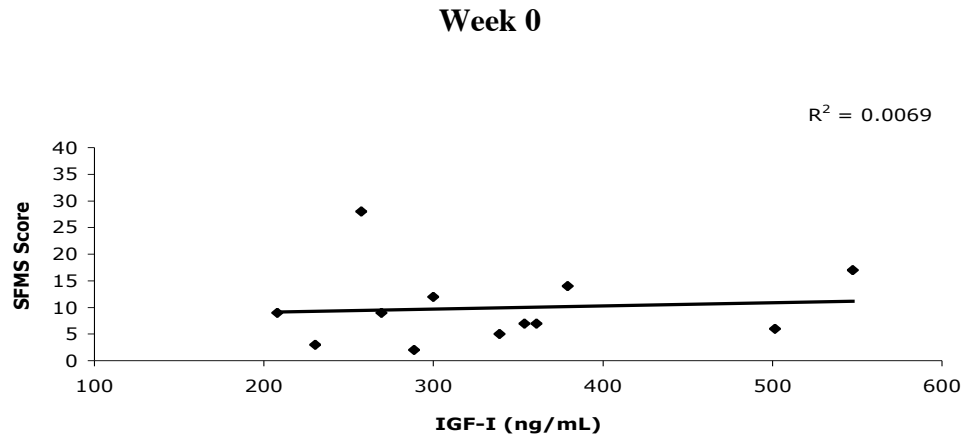
\* Significantly greater IGFBP-3 concentration in female compared to male subjects at all time points,  $p < 0.05$ .

There was a significant positive correlation between IGFBP-3 and SFMS scores at week 0, however, this relationship did not persist after 8 or 16 weeks of training (Figure 16). As seen in Figure 17, there was no correlation between IGF-I and SFMS at any of the testing phases. When IGF-I and IGFBP-3 concentrations were compared between subjects that had SFMS scores greater than 20 and SFMS score less than 20, there were no significant differences in IGF-I or IGFBP-3 concentration across the testing phases for either group. There was no significant relationship between other measures of training status and circulating concentrations of either IGF-I or IGFBP-3.



**Figure 16. The relationship between IGFBP-3 and SFMS scores at pretesting, after 8 and 16 weeks of training.**  
 \*Significant correlation ( $p < 0.05$ )





**Figure 17. The relationship between IGF-I and SFMS scores at pretesting, after 8 weeks and 16 weeks of training.**

## **CHAPTER 5**

### **DISCUSSION**

#### **SUMMARY OF FINDINGS**

The aim of this study was two-fold. The first goal was to evaluate the effects of long-term swim training on resting levels of IGF-I and IGFBP-3, and the second goal was to determine if changes in IGF-I and IGFBP-3 were related to changes in training status. It was hypothesized that IGF-I and IGFBP-3 would increase with increased fitness and athletic performance. In the present study, the relative change in IGF-I from week 0 to week 8 (11.93%) was significantly greater than the relative change from week 8 to week 16 (-4.99%). There were no statistically significant changes in absolute or relative IGFBP-3, VO<sub>2</sub> max, athletic performance, or SFMS scores across the 16-week training period. Resting levels of IGFBP-3 were significantly positively correlated with SFMS scores at the start of the season, however, this relationship did not persist following 8 or 16 weeks of training. There was no correlation between any of the other measures of training status and IGF-I or IGFBP-3.

#### **FITNESS MEASURES**

The study participants were varsity athletes who had been swimming competitively for an average of 9 years. Although measures of fitness did not differ across the testing phases, percent body fat was significantly decreased at week 8 and 16 when compared to pretesting. A decrease in relative body fat is expected with long-term training and this result is consistent with previous swim-training studies (Koziris et al.,

1999). It was expected that  $\text{VO}_2$  max would increase with training, however, improvements in  $\text{VO}_2$  max were not detected in the present study. This may in part be due to the subject's initial aerobic fitness levels. The average  $\text{VO}_2$  max was 47.61 ml/kg/min and is rated as "Excellent" among the normal population (Heyward, 1998). Although a  $\text{VO}_2$  max of 47.61 ml/kg/min may appear low for elite endurance athletes,  $\text{VO}_2$  max tests performed on a cycle ergometer as in the present study can produce  $\text{VO}_2$  max values that are 5-10% lower than tests performed on treadmill protocols (McArdle, Katch & Katch, 2007) and 15% lower than those performed on a swimming specific protocol (Vorontsov, Solomatin & Sidorov 1985). This finding is consistent with the  $\text{VO}_2$  max of elite swimmers between the ages of 18-22 years, which was reported by Vorontsov et al. (1985). The initial  $\text{VO}_2$  max in the present study may be high because eight of the twelve reported to have trained a minimum of three times per week during the off-season. Since initial  $\text{VO}_2$  max was relatively high, the magnitude of any improvements would be small (McArdle et al., 2007). Other studies have also reported no significant changes in  $\text{VO}_2$  max in trained athletes after additional long-term training (Eliakim et al., 1996; Maimoun et al., 2004; Rosendal et al., 2002; Rietjens et al., 2005).

SFMS scores were increased 82% after 8 weeks and 66% after 16 weeks of training. This finding suggests that on average, symptoms of overtraining were elevated at week 8 and week 16. However, other possible physiological symptoms of overtraining such as a decrease in maximum heart rate, a decrease in maximal lactate or a decrease in athletic performance were not observed across the testing phases. The overtraining questionnaire is a subjective evaluation and therefore SFMS scores may be affected by factors other than training status such as illness or stress. It was noted that six of the

twelve participants at week 8 and two participants at week 16 reported having flu-like symptoms, which may have influenced their SFMS scores. It is also reported that scores from the questionnaire may increase with increased training, however, scores higher than 20 are suggestive of overtraining or a situation at risk for it (Brun, 2003).

### **RESTING IGF-I AND IGFBP-3 LEVELS**

Mean resting levels of IGF-I and IGFBP-3 were within reference levels provided by Diagnostic Systems Laboratories (Webster, TX)(Appendix D). Individual data indicated that only one subject at one testing phase had IGF-I levels outside the reference range. It is noted that this subject did have the highest IGF-I levels in all three testing phases of the study, and this subject was also the youngest subject in the study. It is well established that IGF-I levels are higher in younger subjects (Hall et al., 1980).

Individual data also indicated that three subjects had IGFBP-3 levels that were higher than expected at all three testing phases. All three of these values came from female subjects of varying age (18-21yrs), and female subjects typically express higher concentration of IGFBP-3 compared to male subjects (Lofqvist et al., 2004). Based on the finding from Lukanova et al. (2001), it is believed that neither the use of oral contraceptives or menstrual cycle phase had a significant influence on the IGFBP-3 levels.

### **TRAINING EFFECTS ON RESTING IGF-I**

Several studies have indicated that physically fit subjects have higher circulating levels of IGF-I compared to their unfit counterparts (Kelley et al., 1990; Poehlman & Copeland, 1990). Therefore, increased training and fitness levels may result in increased

circulating levels of resting IGF-I. In the present study there were no significant differences in resting IGF-I concentrations after 8 or 16 weeks of exercise training. However, when the data were normalized to baseline values and expressed as percent change, there was a significant difference in results from 0 to 8 weeks versus 8 to 16 weeks.

Our findings do not support the previous work by Koziris et al. (1999), who found circulating levels of IGF-I to increase 70-80% with long-term swim training. The difference in results may be explained by the differences in the training protocols. The average weekly training distances for each month is significantly greater in the present study compared to Koziris et al. (1999) and it is known that exercise volume is an important determinant of hormonal response (Tremblay, Chu & Mureika, 1995). Although the volume was reported to be significantly lower in Koziris et al. (1999) it is possible that the intensity of training was greater than in the present study, or that additional dry land training, such as resistance training was greater in the Koziris study, which could have influenced the hormonal response.

It is also possible that the differences are not due to training variables, but rather due to the type of blood sample collected (i.e. resting vs. acute exercise sample). In the present study all subjects were asked to refrain from physical activity 24 hours prior to blood sample collection in an attempt to eliminate the influence of acute exercise on resting IGF-I levels. This is important because acute exercise typically leads to transient increases in IGF-I (Bang et al., 1990; Copeland & Heggie, in press; Schwarz et al., 1996). It is possible that the samples Koziris and colleagues collected were influenced by previous exercise.

In contrast to the present results, Eliakim et al. (2002), found circulating levels of resting IGF-I to decrease after two weeks of exercise training, followed by an increase to baseline levels in the following two weeks. It is believed that the sudden onset of an exercise-training program may first lead to a hormonal adaptation suggestive of a catabolic state, but at some point, an anabolic rebound occurs (Eliakim et al., 2002). Similar findings were reported by Rosendal et al. (2002) who also found a decrease in IGF-I after four weeks of training, followed by an increase to baseline levels in the proceeding seven weeks of training. These findings would suggest that any training induced changes in IGF-I may be transient. In the present study, blood samples were collected at eight-week intervals, therefore, it is possible that changes in IGF-I may have occurred in the early stages of training and not detected. The biological significance of a transient increase in IGF-I is unknown.

Manetta et al. (2003) reported no change in IGF-I after 4 months of intense cycle training. Similar to the present study, Manetta et al. (2003) eliminated the influence of acute exercise on resting levels of IGF-I by having subjects refrain from physical activity for three days prior to blood sampling. This finding supports the idea that IGF-I may often be influenced by prior exercise.

The nutritional status of the subjects in the present study remained relatively consistent across all three testing phases. On average, calorie intake was 33.74 kcal/kg/day and protein intake was 1.30 g/kg/day across all testing phases. Both calorie and protein intake in the present study were previously found to be adequate in maintaining normal level of IGF-I (Smith et al., 1987). Nutritional status is important because energy deficiency in humans is associated with a decline in serum IGF-I

(Clemmons et al., 1981; Nemet et al., 2004; Ross, 2000; Smith, Underwood & Clemmons, 1995), where as overfeeding is associated with an increase in IGF-I (Forbes et al., 1989). In studies that have reported changes in IGF-I, but did not evaluate nutritional status, it is possible that change in IGF-I were influenced by changes in nutritional status.

I hypothesized that resting levels of IGF-I would increase with increasing fitness and athletic performance. There were no significant changes in  $VO_2$  max or athletic performance across the testing phases. This suggests either the participants started the season with high levels of fitness, or the training program was not sufficient to stimulate changes in  $VO_2$  max or athletic performance. Anecdotal evidence from the athletes and the coaching staff indicated that both the training and competitive season was considered sub-par. It was reported that numerous injuries and illnesses significantly affected the teams' results. It cannot be ruled out that if increases in fitness and athletic performance had occurred, changes in serum IGF-I may also have been observed.

### **TRAINING EFFECTS ON RESTING IGFBP-3**

Since IGFBP-3 plays an important role in the regulation of IGF-I bioavailability, it was hypothesized that not only would IGF-I increase with increased fitness and athletic performance, but resting IGFBP-3 would also increase, which would regulate IGF-I action. However, IGFBP-3 remained consistent across all three testing phases. This is in agreement with Rosendal et al. (2002) and Maimoun et al. (2004) who found no change in resting levels of IGFBP-3 in previously trained subjects following extended physical training. These results would suggest exercise training does not affect resting levels of IGFBP-3.

In contrast, Rosendal et al. (2002) found IGFBP-3 to significantly decrease following training in previously untrained subjects. It was confirmed that the decrease in IGFBP-3 was the result of increased IGFBP-3 proteolysis and was suggested that the relative stress of training must exceed a certain threshold in order for proteolysis and a subsequent decline in IGFBP-3 to occur. It is possible that the athletes in the present study did not exceed the relative stress needed to stimulate IGFBP-3 proteolysis and with a greater training load (intensity X duration), a change in IGFBP-3 may have been observed.

Exercise induced changes in IGFBP-3 are important because changes in IGFBP-3 affect the IGF-I/IGFBP-3 ratio, which provides an index of IGF-I bioavailability. Greater IGF-I bioavailability means more anabolic effects of IGF-I can be expressed. In the present study, the IGF-I/IGFBP-3 ratio was unchanged following 8 and 16 weeks of training, suggesting that the bioavailability of IGF-I was also unchanged. This finding is in agreement with Koziris et al. (1999) who also found no significant difference in IGF-I/IGFBP-3 ratio with training.

Based on the finding from previous studies, it appears the relative stress produced by the training in the present study was not sufficient to stimulate changes in resting IGFBP-3. This could be due to the training program and the initial fitness levels of the participants. It cannot be ruled out that the participants' adherence to the training program and the intensity at which they trained were low and also influenced this result.



## RESTING IGF-I AND IGFBP-3 AND MEASURES OF TRAINING STATUS

Changes in training status may be associated with adaptations in the IGF-I system (Eliakim et al., 2002; Elloumi et al., 2005; Manetta et al., 2003; Poehlman & Copeland, 1990). It was therefore expected that increases in resting IGF-I or IGFBP-3 would be significantly correlated with changes in measures of training status including  $VO_2$  max, athletic performance and SFMS scores.

There was no correlation between IGF-I or IGFBP-3 and  $VO_2$  max in the present study. This finding supports some previous studies, which also found no significant relationship (Eliakim et al., 1996). Poehlman & Copeland, (1990) reported a significant relationship between changes in IGF-I and  $VO_2$  max in elderly, previously untrained subjects following exercise training. Manetta et al. (2003) also found a significant relationship between IGFBP-3 and predicted  $VO_2$  max in previously trained subjects following four months of intense training. However, in the present study,  $VO_2$  max did not change across the 16 weeks, therefore this study cannot confirm if IGF-I or IGFBP-3 is a sensitive marker of *changes* in  $VO_2$  max.

IGFBP-3 levels have been suggested as a possible marker for the catabolic effects of overtraining. Elloumi et al. (2005) found that changes in IGFBP-3 following acute exercise are negatively correlated with scores on an overtraining questionnaire. Elloumi et al. (2005) suggested that IGFBP-3 levels decline as athletes become fatigued and that a decrease in IGFBP-3 compensates for the catabolic state of overtraining by increased IGF-I bioavailability. Despite an increase in SFMS scores, this study did not confirm a relationship between change in SFMS scores and change in resting IGFBP-3. A positive correlation between resting levels of IGFBP-3 and SFMS was noted at the week 0 in the

present study. This indicates that subjects with more symptoms of fatigue had higher levels of IGFBP-3, which is the opposite of what was expected. The significance of this finding is not known and it should be noted this relationship did not persist following 8 or 16 weeks of training. Due to the high variability in physiological responses of these athletes to training and school related stress, perhaps more subjects are needed to detect the relationship. It is important to note that Elloumi et al. (2005) reported a negative relationship between the change in IGFBP-3 following acute exercise and scores from the overtraining questionnaire. It is also noted that only one subject in the present study had a SFMS score that was suggestive of overtraining at week 0, while Elloumi reported three subjects with scores that were suggestive of overtraining. Together these findings indicate that changes in IGFBP-3 level following acute exercise may be a possible marker of overtraining, however, resting levels of IGFBP-3 appear to be a poor indicator of overtraining symptoms.

## **CONCLUSIONS AND RECOMMENDATIONS FOR FUTURE WORK**

This study cannot confirm the hypothesis that resting levels of IGF-I and IGFBP-3 increase with increased fitness and athletic performance. Several factors may have influenced our results including subject's initial fitness levels. Highly trained athletes show little improvements in fitness levels and have blunted a hormone response compared to untrained subjects. It is also possible that the participants in this study did not train with sufficient intensity to stimulate changes in the IGF-I system. It cannot be ruled out that if changes in fitness would have been observed in the present study, changes in the IGF system may have also been observed.

Although the absolute change in IGF-I did not change across the testing phases, the relative change in IGF-I was significantly different from 0 to 8 weeks when compared to 8 to 16 weeks. The main finding in this study was the observed positive correlation between resting IGFBP-3 and SFMS scores at the start of the training season. The biological significance of this relationship remains unknown. SFMS scores appeared to increase following 8 and 16 weeks of training, while IGFBP-3 remained unchanged. This finding suggests resting levels of IGFBP-3 may not be a sensitive marker of training status.

Based on the findings from the present study the following recommendations have been developed for future work. Exercise can vary widely in mode, duration and intensity, therefore, the effects of exercise on IGF-I and IGFBP-3 have been difficult to identify. It would be beneficial to determine the effects of different exercise variables on both IGF-I and IGFBP-3. Since the present study evaluated swimmers age 18-24 years, it would be interesting to see if age influences the effects of exercise training on IGF-I and IGFBP-3. There is also a need to evaluate how different exercise variable affect IGFBP-3 proteolysis. More work is also needed to validate subjective measures of overtraining. Finally, there is a need for research looking at the contribution of locally produced IGF-I and how it is affected by exercise.

## REFERENCES

- Armstrong, L.E., and VanHeest, J.L. (2002). The mechanism of the overtraining syndrome: clues from depression and psychoneuroimmunology. *Sports Medicine*, 32, 185-209.
- Astrand, P.O. (1965). *Work tests with bicycle ergometer*. Varberg, Sweden: AB Cykefabriken Monark.
- Axelsson, J., Qureshi, A.R., Divino-Filho, J.C., Barany, P., Heimbürger, O., Lindholm, B., and Stenvinkel, P. (2006). Are insulin-like growth factor and its binding proteins 1 and 3 clinically useful as markers of malnutrition, sarcopenia and inflammation in end-stage renal disease? *European Journal of Clinical Nutrition*, 60, 718-726.
- Baker, J., Liu, J.P., Robertson, E.J., and Efstratiadis, A. (1993). Role of insulin-like growth factors in embryonic and postnatal growth. *Cell*, 75, 73-82.
- Bang, P., Brandt, J., Degerblad, M., Enberg, G., Kaijser, L., Thoren, M., and Hall, K. (1990). Exercise-induced changes in insulin-like growth factors and their low molecular weight binding protein in healthy subjects and patients with growth hormone deficiency. *European Journal of Clinical Investigations*, 20, 285-292.
- Bang, P., Degerblad, M., Thoren, M., Schwander, J., Blum, W., and Hall, K. (1993). Insulin-like growth factor (IGF)-I and (IGF)-II and IGF binding-protein (IGFBP)-1, (IGFBP)-2 and (IGFBP)-3 in serum from patients with cushings-syndrome. *ACTA Endocrinologica*, 128, 397-404.
- Baxter, R.C., and Martin, J.L. (1986). Radioimmunoassay of growth hormone-dependent insulin-like growth factor binding protein in human plasma. *Journal of Clinical Investigation*, 78, 1504-1512.
- Baxter, R.C. (1994). Insulin-like growth factor binding-proteins in the human circulation: a review. *Hormone Research*, 42, 140-144.
- Bennett, A.E., Wahner, H.W., Riggs, B.L., and Hintz, R.L. (1984). Insulin-like growth factor-I and factor-II- aging and bone density in women. *Journal of Clinical Endocrinology and Metabolism*, 59, 701-704.
- Berelowitz, M., Szabo, M., Frohman, L.A., Chu, L., Hintz, R.L. (1981). Somatomedin-C mediates growth hormone negative feedback by effects on both the hypothalamus and the pituitary. *Science*, 212, 1279-1281.

- Binoux, M., and Hossenlopp, P. (1988). Insulin-like growth factor (IGF) and IGF-binding proteins: comparison of human serum and lymph. *Journal of Endocrinology and Metabolism*, 134, 509-514.
- Blat, C., Villaudy, J., and Binoux, M. (1994). In-vivo proteolysis of serum insulin-like growth-factor (IGF) binding protein-3 results in increased availability of IGF to target-cells. *Journal of Clinical Investigation*, 93, 2286-2291.
- Blum, W.F., Ranke, M.B., Kietzmann, K., Gauggel, E., Zeisel, H.J., and Bierich, J.R. (1990). A specific radioimmunoassay for the growth hormone (GH)-dependent somatomedin-binding protein: its use for diagnosis of GH deficiency. *Journal of Clinical Endocrinology and Metabolism*, 70, 1292-1298.
- Blum, W.F., and Ranke, M.B. (1991). Plasma IGFBP-3 levels as clinical indicators. In: E.M. Spencer (Ed). *Modern concepts of insulin-like growth factors*. Elsevier Science, New York. 381-393.
- Blum, W.F., Albertssonwikland, K., Roseberg, S., and Ranke, M.B. (1993). Serum levels of insulin-like growth factor-I (IGF-I) and IGF binding protein-3 reflect spontaneous growth-hormone secretion. *Journal of Clinical Endocrinology and Metabolism*, 76, 1610-1616.
- Borg, G. (1982). Psychophysical bases of perceived exertion. *Medicine and Science in Sports and Medicine*, 14, 377-381.
- Borst, S.E., Millard, W., and Lowenthal, D. (1994). Growth hormone, exercise, and aging: the future of therapy for the frail elderly. *Journal of the American Geriatrics Society*. 42, 528-535.
- Brahm, H., Piehl-Aulim, K., Saltin, B., and Ljunghall, S. (1997). Net fluxes over working thigh of hormones, growth factors and biomarkers of bone metabolism during short lasting dynamic exercise. *Calcified Tissue International*, 60, 175-180.
- Brun, J.F. (2003). The overtraining: to a system of evaluation usable by routine examinations. *Science and Sports*, 18, 282-286.
- Bunn, C.R., and Fowlkes, J.L. (2003). Insulin-like growth factor binding protein proteolysis. *Trends in Endocrinology and Metabolism*, 14, 176-181.
- Butler, A.A., and LeRoith, D. (2001). Minireview: Tissue-specific versus generalized gene targeting of the *igf1* and *igf1r* genes and their roles in insulin-like growth factor physiology. *Endocrinology*, 142, 1685-1688.
- Cappola, A.R., Bandeen-Roche, K., Wand, G.S., Volpato, S., and Fried, L.P. (2001). Association of IGF-I levels with muscular strength and mobility in older women. *Journal of Clinical Endocrinology and Metabolism*, 86, 4139-4146.

Cappon, J.P., Brasel, J.A., Mohan, S., and Cooper, D.M. (1994). Effect of brief exercise on circulating insulin-like growth factor I. *Journal of Applied Physiology*, 76, 2490-2496.

Chadan, S.G., Dill, R.P., Vanderhoek, K., and Parkhouse, W.S. (1999). Influence of physical activity on plasma insulin-like growth factor-I and insulin-like growth factor binding proteins in healthy older women. *Mechanisms of Aging and Development*, 109, 21-34.

Chicharro, J.L., Lopez-Calderon, A., Hoyos, J., Martin-Velasco, A.I., Villa, G., Villanua, M.A., and Lucia, A. (2001). Effects of endurance cycling competition on resting serum insulin-like growth factor-I (IGF-I) and its binding proteins IGFBP-1 and IGFBP-3. *British Journal of Sports Medicine*, 35, 303-307.

Clemmons, D.R., Klibanski, A., Underwood, L.E., McArthur, J.W., Ridgeway, E.C., Beitins, I.Z., and Van Wyk, J.J. (1981). Reduction of plasma immunoreactive somatomedin C during fasting in humans. *Journal of Clinical Endocrinology and Metabolism*, 53, 1247-1250.

Clemmons, D.R., and Van Wyk, J.J. (1984). Factors controlling blood concentration of somatomedin C. *Journal of Clinical Endocrinology and Metabolism*, 13, 113-118.

Cohick, W.S., and Clemmons, D.R. (1993). The insulin-like growth factors. *Annual Review of Physiology*, 55, 131-153.

Conover, C.A., Clarkson, J.T., and Bale, L.K. (1995). Effect of glucocorticoid on insulin-like growth factor (IGF) regulation of IGF-binding protein expression in fibroblasts. *Endocrinology*, 136, 1403-1410.

Copeland, J.L. and Heggie, L. (in press). Changes in IGF-I and IGFBP-3 during continuous and interval exercise. *International Journal of Sports Medicine*.

Copeland, K.C., Underwood, L.E., and VanWyk, J.J. (1980). Induction of immunoreactive somatomedin-c in human-serum by growth-hormone dose-response relationship and effect on chromatographic profiles. *Journal of Endocrinology and Metabolism*, 50, 690-697.

Corpas, E., Harman, S., and Blackman, M. (1994). Human growth hormone and human aging. *Endocrine Reviews*, 14, 20-39.

Dall, R., Lange, K.H.W., Kjaer, M., Jorgensen, J.O.L., Christiansen, J.S., Orskov, H., and Flyvbjerg, A. (2001). No evidence of insulin-like growth factor-binding protein 3 proteolysis during a maximal exercise test in elite athletes. *Journal of Clinical Endocrinology & Metabolism*, 86, 669-674.

Daughaday, W.H. (2000). Growth hormone axis overview-somatomedin hypothesis. *Pediatric Nephrology*, 14, 537-540.

Daughaday, W.H., Hall, K., Raben, M.S., Salmon, W.D., van den Brande, J.L., & Van Wyk, J.J. (1972). Somatomedin: proposed designation for sulphation factor. *Nature*, *235*, 107.

Daughaday, W.H., and Rotwein, P. (1989). Insulin-like growth factors I and II. Peptide messenger ribonucleic acid and gene structures, serum, and tissue concentrations. *Endocrinology Review*, *10*, 68-91.

Davenport, M.L., Clemmons, D.R., Miles, M.V., Camacho-Hubner, C., D'Ercole, A.J., and Underwood, L.E. (1990). Regulation of serum insulin-like growth factor-I (IGF-I), IGF binding proteins during rat pregnancy. *Endocrinology*, *127*, 1278-1286.

D'Ercole, A.J., Applewhite, G.T., and Underwood, L.E. (1980). Evidence that somatomedin is synthesized by multiple tissues in the fetus. *Developmental Biology*, *75*, 315-328.

DeMellow, J.S.M., and Baxter, R.C. (1988). Growth hormone dependent insulin-like growth factor binding protein both inhibits and potentiates IGF-I stimulated DNA synthesis in skin fibroblasts. *Biochemical and Biophysical Research Communications*, *156*, 199-204.

Deschenes, M.R., Kraemer, W.J., Maresh, C.M., and Crivello, J.F. (1991). Exercise-induced hormonal changes and their effects upon skeletal muscle tissue. *Sports Medicine*, *12*, 80-93.

DiBattista, J.A., Dore, S., Morin, N., and Aribat, T. (1996). Prostaglandin E2 up-regulates insulin-like growth factor binding protein-3 expression and synthesis in human articular chondrocytes by a c-AMP-independent pathway: role of calcium and protein kinase A and C. *Journal of Cellular Biochemistry*, *63*, 320-333.

Dill, D.B., and Costill, D.L. (1974). Calculation of percentage changes in volumes of blood, plasma, and red cells in dehydration. *Journal of Applied Physiology*, *37*, 247-248.

Eliakim, A., Brasel, J., Mohan, S., Barstow, T.J., Berman, and Cooper, D.M. (1996). Physical fitness, endurance training, and the growth hormone-insulin-like growth factor I system in adolescent females. *Journal of Clinical Endocrinology and Metabolism*, *81*, 3986-3992.

Eliakim, A., Brasel, J.A., Mohan, S., Wong, W.L., and Cooper, D.M. (1998). Increased physical activity and the growth hormone-IGF-I axis in adolescent males. *American Journal of Physiology*, *275*, R308-R314.

Eliakim, A., Youngman, O., and Cooper, D.M. (2000). Effect of single wrist exercise on fibroblast growth factor-2, insulin-like growth factor, and growth hormone. *American*

*Journal of Physiology-Regulatory, Integrative and Comparative Physiology*, 279, 548-553.

Eliakim, A., Nemet, D., Bar-Sela, S., Higer, Y., and Falk, B. (2002). Changes in circulating IGF-I and their correlation with self-assessment and fitness among elite athletes. *International Journal of Sports Medicine*, 23, 600-603.

Eliakim, A., Nemet, D., and Cooper, D.M. (2005). Exercise, training and the GH-IGF-I axis. In: W.J. Kraemer (Ed). *The endocrine system in sport and exercise*. Blackwell Publishing, Malden, Massachusetts.

Elias, A.N., Pandian, M.R., Wang, L., Suarez, E., James, N., and Wilson, A.F. (2000). Leptin and IGF-I levels in unconditioned male volunteers after short-term exercise. *Psychoneuroendocrinology*, 25, 453-461.

Elloumi, M., El Eli, N., Zaouali, M., Maso, F., Filaire, E., Tabka, Z., and Lac, G. (2005). IGFBP-3, a sensitive marker of physical training and overtraining. *British Journal of Sports Medicine*, 39, 604-610.

Fargo, L.M., and Chowen, J.A. (2005). Basic physiology of the growth hormone/insulin-like growth factor axis. *Advances in Experimental Medicine and Biology*, 567, 1-25.

Ferry, R.J., katz, L.E., Grimberg, A., Cohen, P., and Weinzimer, S.A. (1999). Cellular actions of insulin-like growth factor binding proteins. *Hormone and Metabolic Research*, 31, 192-202.

Florini, J.R., Ewton, D.Z., Evinger-Hodges, M.J., Falen, R.L., Lau, R.L., Rogan, J.F., and Vertel, B.M. (1984). Stimulation and inhibition of myoblast differentiation by hormones. *In Vitro - Journal of the Tissue Culture Association*, 20, 942-958.

Florini, J.R., Ewton, D.Z., and Coolican, S.A. (1996). Growth hormone and the insulin-like growth factor system in myogenesis. *Endocrine Reviews*, 17, 481-517.

Forbes, G.B., Brown, M.R., Welle, S.L., and Underwood, L.E. (1989). Hormonal response to overfeeding. *American Journal of Clinical Nutrition*, 49, 608-611.

Friedl, K.E. (1994). Performance-enhancing substances: effects, risks, and appropriate alternatives. In: T.R. Baechle (Ed). *Essentials of Strength Training and Conditioning*. Human Kinetics, Champaign, Illinois. 188-202.

Froesch, E.R., Zapf, J., Audhya, T.K., Benporath, E., Segen, B.J., Gibson, K.D. (1976). Nonsuppressible insulin like activity and thyroid hormones: major pituitary-dependent sulfation factors for cartilage. *Proceedings of the National Academy of Sciences of the United States of America*, 73, 2904-2908.



Frystyk, J., Nyholm, B., Skjaerbaek, C., Baxter, R.C., Schmitz, O., and Orskov, H. (2003). The circulating IGF system and its relationship with 24-h glucose regulation and insulin sensitivity in healthy subjects. *Clinical Endocrinology*, 58, 777-784.

Frystyk, J. (2004). Free insulin-like growth factors- measurements and relationships to growth hormone secretion and glucose homeostasis. *Growth Hormone & IGF Research*, 14, 337-375.

Gillespie, C., Read, L.C., Bagley, C.J., and Ballard, F.J. (1990). Enhanced potency of truncated insulin-like growth factor-I (des(1-3)IGF-1) relative to IGF-I in lit/lit mice. *Journal of Endocrinology*, 127, 401-405.

Giudice, L.C., Farrell, E.M., Pham, H., Lamson, G., and Rosenfeld, R.G. (1990). Insulin-like growth factors in maternal serum throughout gestation and in the puerperium: effects of a pregnancy-associated serum protease activity. *Journal of Clinical Endocrinology and Metabolism*, 71, 806-816.

Goldspink, G., and Harridge, D.R. (2004). Growth factors and muscle ageing. *Experimental Gerontology*, 39, 1433-1438.

Gomez, J.M., Maravall, F.J., Gomez, N., Navarro, M.A., Casamitjana, R., and Soler, J. (2004). The IGF-I system component concentrations that decrease with ageing are lower in obesity in relationship to body mass index and body fat. *Growth Hormone & IGF Research*, 14, 91-96.

Gram, I.T., Norat, T., Rinaldi, S., Dossus, L., Lukanova, A., Tehard B. et al. (2006). Body mass index, waist circumference and waist-hip ratio and serum levels of IGF-I and IGFBP-3 in European women. *International Journal of Obesity*, 30, 1623-1631.

Guler, H.P., Zapf, J., and Froesch, E.R. (1987). Short-term metabolic effects of recombinant human insulin-like growth factor-I in healthy adults. *New England Journal of Medicine*, 317, 137-140.

Hall, K., Enberg, G., Ritzen, M., Svan, H., Fryklund, L., and Takano, K. (1980). Somatomedins A levels in serum from healthy children and from children with growth hormone deficiency or delayed puberty. *Acta Endocrinology*, 94, 155-165.

Hall, K., and Sara, V.R. (1984). Somatomedin levels in childhood, adolescence and adult life. *Clinics in Endocrinology and Metabolism*, 13, 91-112.

Hamon, G.A., Hunt, T.K., and Spencer, E.M. (1993). In vivo effects of systemic insulin-like growth factor-I alone and complexed with insulin-like growth factor binding protein-3 on corticosteroid suppressed wounds. *Growth Regulation*, 3, 53-56.

Harrela, M., Koistinen, H., Kaprio, J., Lehtovirta, M., Tuomilehto, J., Eriksson, J., Toivanen, L., Koskenvuo, M., Leinonen, P., Koistinen, R., and Seppala, M. (1996).

- Genetic and environmental components of interindividual variation in circulating levels of IGF-I, IGF-II, IGFBP-1, and IGFBP-3. *Journal of Clinical Investigations*, 98, 2612-2615.
- Hedge, G.A., Colby, H.D., and Goodman, R.L. (1987). *Clinical Endocrine Physiology*. Philadelphia: W.B. Saunders Company.
- Heyward, V.H. (1998). *Advanced fitness and exercise prescription*. Champaign, IL: Human Kinetics.
- Holt, R.I.G., Simpson, H.L., and Sonksen, P.H. (2003). The role of the growth hormone-insulin-like growth factor axis in glucose homeostasis. *Diabetic Medicine*, 20, 3-15.
- Hossenlopp, P., Segovia, B., Iassarre, C., Roghani, M., Bredon, M., and Binoux, M. (1990). Evidence of enzymatic degradation of insulin-like growth factor-binding proteins in the 150K complex during pregnancy. *Journal of Clinical Endocrinology and Metabolism*, 71, 797-805.
- Hug, M., Mullis, P.E., Vogt, M., Ventura, N., and Hoppeler, H. (2003). Training modalities: over-reaching and over-training in athletes, including a study of the role of hormones. *Best Practice & Research Clinical Endocrinology and Metabolism*, 17, 191-209.
- Hunziker, E.B., Wagner, J., and Zapf, J. (1994). Differential effects of insulin-like growth factor-I and growth hormone on developmental stages of rat growth plate chondrocytes in vivo. *Journal of Clinical Investigation*, 93, 1078-1086.
- Huynh, H., Yang, Y.F., and Pollak, M. (1996). Estradiol and antiestrogens regulate a growth inhibitory insulin-like growth factor binding protein 3 autocrine loop in human breast cancer cells. *Journal of Biological Chemistry*, 271, 1016-1021.
- Jackson, A.S., and Pollock, M.L. (1985). Practical assessment of body composition. *Physician and Sportsmedicine*, 13, 76-90.
- Jahreis, G., Kauf, E., Frohner, G., and Schmidt, H.E. (1991). Influence of intensive exercise on insulin-like growth factor-I, thyroid and steroid hormones in female gymnasts. *Growth and Regulation*, 1, 95-99.
- Jones, J.I., and Clemmons, D.R. (1995). Insulin-like growth factor and their binding proteins: Biological actions. *Endocrine Review*, 16, 3-34.
- Juul, A., Main, K., Blum, W.F., Lindholm, J., Ranke, M.B., and Skakkebaek, N.E. (1994). The ratio between serum levels of insulin-like growth factor (IGF)-I and the IGF binding proteins (IGFBP-1, 2 and 3) decreases with age in healthy adults and is increased in acromegalic patients. *Clinical Endocrinology*, 41, 85-93.

- Kanaley, J.A., Frystyk, J., Moller, N., Dall, R., Chen, J.W., Nielsen, S.C., Christiansen, J.S., Jorgensen, J.O.L., and Flyvbjerg. (2005). The effect of submaximal exercise on immuno- and bioassayable IGF-I in patients with GH-deficiency and healthy subjects. *Growth Hormone & IGF-I Research*, 15, 283-290.
- Kanety, H., Karasik, A., Klinger, B., Silbergeld, A., and Laron, Z. (1993). Long-term treatment of laron type dwarfs with insulin-like growth factor-I increases serum insulin-like growth factor-binding protein-3 in the absence of growth-hormone activity. *ACTA Endocrinologica*, 128, 144-149.
- Katz, L.E.L., Rosenfeld, R.G., and Cohen, S.P. (1995). Clinical-significance of insulin-like growth-factor binding proteins (IGFBPS). *Endocrinologist*, 5, 36-43.
- Kelly, P.J., Eisman, J.A., Stuart, M.C., Pocock, N.A., Sambrook, P.N., and Gwinn, T.H. (1990). Somatomedin-c, physical fitness, and bone density. *Journal of Clinical Endocrinology and Metabolism*, 70, 718-723.
- Koistinen, H., Koistinen, R., Selenius, L., Ylikorkala, O., and Seppala, M. (1996). Effects of marathon run on serum IFG-I and IGF-binding protein 1 and 3 levels. *Journal of Applied Physiology*, 80, 760-764.
- Koziris, L.P., Hickson, R.T., Chatterton, J.R., Groseth, R.T., Christine, J.M., Goldflies, D.G., and Unterman, T.G. (1999). Serum levels of total and free IGF-1 and IGFBP-3 are increased and maintained in long-term training. *Journal of Applied Physiology*, 86, 1436-1442.
- Kraemer, W.J. (1994). Neuroendocrine responses to resistance exercise. In: T.R. Baechle (Ed). *Essentials of Strength Training and Conditioning*. Human Kinetics, Champaign, Illinois. 86-107.
- Lalou, C., and Binoux, M. (1993). Evidence that limited proteolysis of insulin-like growth factor binding protein-3 (IGFBP-3) occurs in the normal state outside the bloodstream. *Regulatory Peptides*, 48, 179-188.
- Laron, Z., Klinger, B., Erster, B., and Anin, S. (1988). Effects of acute administration of insulin-like growth factor-I in patients with Laron-type dwarfism. *Lancet*, 2, 1170-1172.
- Laron, Z. (1993). An update on Laron syndrome. *Archives of Disease in Childhood*, 68, 345-346.
- LeRoith, D., Scavo, L., and Butler, A. (2001a). What is the role of circulating IGF-1? *Trends in Endocrinology & Metabolism*, 12, 48-52.
- LeRoith, D., Bondy, C., Yakar, S., Liu, J., and Butler, A. (2001b). The somatomedin hypothesis: 2001. *Endocrine Reviews*, 22, 53-74.

- LeRoith, D., and Roberts, C. T. (1993). Insulin-like growth factor and their receptors in normal physiology and pathological states. *Journal of Pediatric Endocrinology*, 6, 251-255.
- LeRoith, D., Werner, H., Beitner Johnson, D., and Roberts Jr., C.T. (1995). Molecular and cellular aspects of the insulin-like growth factor-I receptor. *Endocrine Reviews*, 16, 143-163.
- Levinovitz, A., Jennische, E., Oldfors, A., Edwall, D., Norstedt, G. (1992). Activation of insulin-like growth factor-II expression during skeletal-muscle regeneration in the rat – correlation with myotube formation. *Molecular Endocrinology*, 6, 1227-1234.
- Liu, J.P., Baker, J., Perkins, A.S., Robertson, E.J., and Efstratiadis, A. (1993). Mice carrying null mutations of the genes encoding insulin-like growth factor I (igf-1) and type 1 IGF receptors (igf1r). *Cell*, 75, 59-72.
- Lofqvist, C., Andersson, E., Gelander, L., Rosberg, S., Hulthen, L., Blum, W.F., and Wikland, K.A. (2004). Reference values for insulin-like growth factor-binding protein-3 (IGFBP-3) and the ratio of insulin-like growth factor-I to IGFBP-3 throughout childhood and adolescence. *Journal of Clinical Endocrinology and Metabolism*, 90, 1420-1427.
- Lukanova, A., Toniolo, P., Akhmedkhanov, A., Hunt, K., Rinaldi, S., Zeleniuch-Jacquotte, A., Haley, N.J., Riboli, E., Stattin, P., Lundin, E., and Kaaks, R. (2001). A cross-sectional study of IGF-I determinants in women. *European Journal of Cancer Prevention*, 10, 443-452.
- Lukanova, A., Soderberg, S., Stattin, P., Palmqvist, R., Lundin, E., Biessy, C. et al. (2002). Nonlinear relationship of insulin-like growth factor (IGF)-I and IGF-I/IGF-binding protein-3 ratio with indices of adiposity and plasma insulin concentrations. *Cancer Causes & Control*, 13, 509-516.
- Lukanova, A., Lundin, E., Zeleniuch-Jacquotte, A., Muti, P., Mure, A., Rinaldi, S. et al. (2004). Body mass index, circulating levels of sex-steroid hormones, IGF-I and IGF-binding protein-3: a cross-sectional study in healthy women. *European Journal of Endocrinology*, 150, 161-171.
- Maimoun, L., Galy, O., Manetta, J., Coste, O., Peruchon, E., Micallef, J.P., Mariano-Goulart, D., Couret, I., Sultan, C., and Rossi, M. (2004). Competitive season of triathlon does not alter bone metabolism and bone mineral status in male triathletes. *International Journal of Sports Medicine*, 25, 230-234.
- Manetta, J., Brun, J.F., Maimoun, L., Fedou, C., Prefaut, C., and Mercier, J. (2003). The effect of intensive training on insulin-like growth factor I (IGF-I) and IGF binding proteins I and 3 in competitive cyclists: relationships with glucose disposal. *Journal of Sports Sciences*, 21, 147-154.

- Martin, J.L., and Baxter, R.C. (1992). Insulin-like growth factor binding protein-3: biochemistry and physiology. *Growth Hormone*, 2, 88-99.
- Maso, F., Lac, G., and Brun, J.F. (2005). Analysis and interpretation of SFMS questionnaire for the detection of early signs of overtraining: a multicentric study. *Science and Sport*, 20, 12-20.
- Mathews, L.S., Hammer, R.E., Behringer, R.R., Dercole, A.J., Bell, G.I., Brinster, R.L., and Palmiter, R.D. (1988). Growth enhancement of transgenic mice expressing human insulin-like growth factor-I. *Endocrinology*, 123, 2827-2833.
- McArdle, W., Katch, F., and Katch, V. (2007). Exercise physiology: Energy, nutrition and human performance (6<sup>th</sup> ed.). Baltimore: Lippincott Williams and Wilkins.
- McCusker, R.H., Campion, D.R., Jones, W.K., Clemmons, D.R. (1989). The insulin-like growth factor-binding proteins of porcine serum: endocrine and nutritional regulation. *Endocrinology*, 125, 2967-2972.
- McKenzie, D.C. (1999). Markers of excessive exercise, *Canadian Journal of Applied Physiology*. 24, 66-73.
- Merimee, T.J., Zapf, J., and Froesch, E.R. (1982). Insulin-like growth factors in the fed and fasted states. *Journal of Clinical Endocrinology and Metabolism*, 55, 999-1002.
- Mohan, S. (1994). Insulin-like growth factor binding proteins in bone cell regulation. *Growth Regulation*, 3, 67-70.
- Mohan, S. and Baylink, D.J. (1996). Editorial: Insulin-like growth factor (IGF)-binding proteins in serum- do they have additional roles besides modulation the endocrine IGF actions? *Journal of Clinical Endocrinology and Metabolism*, 81, 3817-3820.
- Mohan, S., and Baylink, D.J. (2002). Beyond carrier proteins: IGF-binding proteins are multifunctional and act via IGF-dependent and –independent mechanisms. *Journal of Endocrinology*, 175, 19-31.
- Morgan, W.P., Brown, D.R., Raglin, J.S., O'Connor, P.J., and Ellickson, K.A. (1987). Physiology monitoring of overtraining and staleness, *British Journal of Sport Medicine*. 21, 107-114.
- Muller, E.E., Locatelli, V., and Cocchi, D. (1999). Neuroendocrine control of growth hormone and secretion. *Physiological Reviews*, 79, 511-607.
- Nemet, D., Connolly, P.H., Pontello-Pescatello, A.M., Rose-Gottron, C., Larson, J.K., Galassetti, P., and Cooper, D.M. (2004). Negative energy balance plays a major role in the IGF-I response to exercise training. *Journal of Applied Physiology*, 96, 276-282.

- Ohlsson, C., Nilsson, A., Isaksson, O., & Lindahl, A. (1992). Growth hormone induces multiplication of the slowly cycling germinal cells of the rat tibial growth plate. *Proceedings of the National Academy of Sciences of the United States of America*, *89*, 9826-9830.
- Paye, J.M., and Fosten-Williams, K. (2006). Regulation of insulin-like growth factor-I (IGF-I) delivery by IGF binding proteins and receptors. *Annals of Biomedical Engineering*, *34*, 618-632.
- Poehlman, E.T., Rosen, C.J., and Copeland, K.C. (1994). The influence of endurance training on insulin-like growth-factor-I in older individuals. *Metabolism*, *43*, 1401-1405.
- Poehlman, E.T., and Copeland, K.C. (1990). Influence of physical activity on insulin-like growth factor-I in healthy younger and older men. *Journal of Clinical Endocrinology and Metabolism*, *71*, 1468-1473.
- Poretsky, L., Glover, B., Laumas, V., Kalin, M., and Dunaif, A. (1988). The effects of experimental hyperinsulinemia on steroid secretion, ovarian insulin binding, and ovarian insulin-like growth factor I binding in the rat. *Endocrinology*, *122*, 581-585.
- Powell-Braxton, L., Hollingshead, P., Warburton, C., Dowd, M., Pitts-Meek, S., Dalton, D., Gillett, N., and Stewart, T.A. (1993). IGF-I is required for normal embryonic growth in mice. *Genes and Development*, *7*, 2609-2617.
- Quinn, L.S., Steinmetz, B., Mass, A., Ong, L., and Kaleko, M. (1994). Type-I insulin-like growth factor receptor overexpression produces dual effects on myoblast proliferation and differentiation. *Journal of Cell Physiology*, *159*, 387-398.
- Rajaram, S., Baylink, D.J., and Mohan, S. (1997). Insulin-like growth factor-binding proteins in serum and other biological fluids: regulation and functions. *Endocrine Reviews*, *18*, 801-831.
- Rasmussen, M.H., Hvidberg, A., Juul, A., Main, K.M., Gotfredsen, A., Skakkebaek, N.E., and Hilsted, J. (1995). Massive weight loss restores 24-h growth hormone release profiles and serum insulin-like growth factor-I levels in obese subjects. *Journal of Clinical Endocrinology and Metabolism*, *80*, 1407-1415.
- Rietjens, G.J., Kuipers, H., Adam, J.J., Saris, W.H., van Breda, E., van Hamont, D., and Keizer, H.A. (2005). Physiological, biochemical and psychological markers of strenuous training-induced fatigue. *International Journal of Sports Medicine*, *26*, 16-26.
- Rinderknecht, E., Humbel, R.E. (1978a). The amino acid sequence of human insulin-like growth factor I and its structural homology with proinsulin. *Journal of Biological Chemistry*, *253*, 2769-2776.

Rinderknecht, E., Humbel, R.E. (1978b). Primary structure of human insulin-like growth factor II. *FEBS Letters*, 89, 283-286.

Roelen, C.A.M., deVries, W.R., Koppeschaar, H.P.F., Vervoorn, C., Thijssen, J.H.H., and Blankenstein, M.A. (1997). Plasma insulin-like growth factor-I and high affinity growth hormone-binding protein levels increase after two weeks of strenuous physical training. *International Journal of Sports Medicine*, 18, 238-241.

Ross, R.J.M. (2000). GH, IGF-I and binding proteins in altered nutritional states. *International Journal of Obesity*, 24, 92-95.

Rosendal, L., Langberg, H., Flyvbjerg, A., Frystyk, J., Orskov, H., and kjaer, M. (2002). Physical capacity influences the response of insulin-like growth factor and its binding proteins to training. *Journal of Applied Physiology*, 93, 1669-1675.

Rudman, D. (1985). Growth Hormone, body, composition and aging. *Journal of American Geriatrics Association*, 33, 800-807.

Salmon, W.D., and Daughaday, W.H. (1957). A hormonally controlled serum factor which stimulates sulfate incorporation by cartilage in vitro. *Journal of Laboratory and Clinical Medicine*, 49, 825-836.

Schmitz, K.H., Ahmed, R.L., and Yee, D. (2002). Effects of a 9-month strength training intervention on insulin, insulin-like growth factor (IGF)-I, IGF-binding protein (IGFBP)-I, and IGFBP-3 in 30-50-year-old women. *Cancer Epidemiology, Biomarkers & Prevention*, 11, 1597-1604.

Schwarz, A.J., Brasel, J.A., Hintz, R.L., Mohan, S., and Cooper, D.M. (1996). Acute effects of brief low-and-high intensity exercise on circulation insulin-like growth factor (IGF) I, II and IGF-binding protein-3 and its proteolysis in young healthy men. *Journal of Clinical Endocrinology and Metabolism*, 81, 3492-3497.

Silha, J.V., Sheppard, P.C., Mishra, S., Gui, Y.T., Schwartz, J., Dodd, J.G., and Murphy, L.J. (2006). Insulin-like growth factor (IGF) binding protein-3 attenuates prostate tumor growth by IGF-dependent and IGF-independent mechanisms. *Endocrinology*, 147, 2112-2121.

Smith, A.T., Clemmons, D.R., Underwood, L.E., BenEzra, V., and McMurray, R. (1987). The effect of exercise on plasma somatomedin-C/insulin-like growth factor I concentrations. *Metabolism*, 36, 533-537.

Smith, W.J., Underwood, L.E., and Clemmons, D.R. (1995). Effects of caloric or protein restriction on insulin-like growth factor-I (IGF-I) and IGF-binding proteins in children and adults. *Journal of Clinical Endocrinology and Metabolism*, 80, 443-449.

Steinacker, J.M., Lormes, W., Reissnecker, S., and Liu, Y. (2004). New aspects of the hormone and cytokine response to training. *European Journal of Applied Physiology*, 91, 382-391.

Suikkari, A.M., Koivisto, V.A., Rutanen, E.M., Ykijarvinen, H., Karonen, S.L., and Seppala, M. (1988). Insulin regulates the serum levels of low-molecular weight insulin-like growth factor-binding protein. *Journal of Clinical Endocrinology and Metabolism*, 66, 266-272.

Suikkari, A.M., Sane, T., Seppala, M., Yki-Jarvinen, H., Karonen, S.L., and Koivisto, V.A. (1989). Prolonged exercise increases serum insulin-like growth factor-binding protein concentrations. *Journal of Clinical Endocrinology and Metabolism*, 68, 141-144.

Thissen, J.P., Ketelslegers, J.M., and Underwood, L.E. (1994). Nutritional regulation of the insulin-like growth-factors. *Endocrine Reviews*, 15, 80-101.

Tremblay, M.S., Chu, S.Y., and Mureika, R. (1995). Methodological and statistical consideration for exercise related hormone evaluations. *Sports Medicine*, 20, 90-108.

Turkalj, I., Keller, U., Ninnis, R., Vosmeer, S., and Stauffacher, W. (1992). Effect of increasing doses of recombinant human insulin-like growth factor-I on glucose, lipid, and leucine metabolism in man. *Journal of Clinical Endocrinology and Metabolism*, 75, 1186-1191.

Ueland, T. (2005). Gh/IGF-I and bone resorption in vivo and in vitro. *European Journal of Endocrinology*, 152, 327-332.

Van, V.K., Lund, P.K., Lee, D.C., and D'Ercole, A.J. (1988). Expression of somatomedin/insulin-like growth factor messenger ribonucleic acids in the human fetus: Identification, characterization, and the tissue distribution. *Journal of Clinical Endocrinology and Metabolism*, 66, 422-429.

Vorontsov, A.R., Solomatin, V.R., Sidorov, N.N. (1985). Aerobic and anaerobic capacity of trained swimmers in specific and non-specific exercises at pre-competitive period. Moscow, Russia: State Central Institute of Physical Culture,

Wang, J., Zhou, J., Cheng, C.M., Kopchick, J.J., and Bondy, C.A. (2004). Evidence supporting dual, IGF-I-independent and IGF-I-Dependent, roles for GH in promoting longitudinal bone growth. *Journal of Endocrinology*, 180, 247-255.

Weltman, A., Weltman, J.Y., Hartman, M.L., Abbott, R.D., Rogol, A.D., Evans, W.S., and Veldhuis, J.D. (1994). Relationship between age, percentage body fat, fitness, and 24-hour growth hormone release in healthy young adults: effects of gender. *Journal of Clinical Endocrinology and Metabolism*, 78, 543-548.



Werner, H., Woloschak, M., Stannard, B., Shen-Orr, Z., Roberts, C.T., and LeRoith, D. (1991). The insulin-like growth factor I receptor: molecular biology, heterogeneity, and regulation. In: D. LeRoith (Ed). *Insulin-like Growth Factors: Molecular and Cellular Aspects*. CRC Press Inc. Boca Raton, Florida. 18-47.

Wilson, D.P. and Horowitz, J.L. (1987). Exercise-induced changes in growth-hormone and somatomedin-c. *American Journal of the Medical Sciences*, 293, 216-217.

Zapf, J., Waldvogel, M., and Froesch, E.R. (1975). Binding of nonsuppressible insulin-like activity to human serum: evidence for a carrier protein. *Archives of Biochemistry and Biophysics*, 168, 638-645.

Zapf, J., Schoenle, E., Jagars, G., Sand, I., Grunwald, J., and Froesch, E.R. (1979). Inhibition of the action of nonsuppressible insulin-like activity on isolated fat cells by binding to its carrier protein. *Journal of Clinical Investigation*, 63, 1077-1084.

Zapf, J. (1995). Physiological role of the insulin-like growth factor binding proteins. *European Journal of Endocrinology*, 132, 645-654.

Zanconato, S., Moromisato, D.Y., Moromisato, M.Y., Woods, J., Rrasel, J.A., LeRoith, D., Roberts, C.T., and Cooper, D.M. (1994). Effects of training and growth-hormone suppression on insulin-like growth-factor-I messenger-RNA in young rats. *Journal of Applied Physiology*, 76, 2204-2209.

**APPENDIX A**  
**ABBREVIATIONS**

## **APPENDIX A**

### **Abbreviations**

The following is a list of abbreviations that are used throughout this thesis.

ALS – Acid labile subunit

BMI – Body mass index

SFMS – French Society of Sports Medicine (in English)

CV – Co-efficient of Variation

ELISA - Enzyme-linked Immunosorbent assay

GH – Growth hormone

GHD – Growth hormone deficiency

GHRH – Growth hormone releasing hormone

IGF-I – Insulin-like growth factor

IGFBP-3 – Insulin-like growth factor 3

IGF-I/IGFBP-3 – Insulin-like growth factor I / Insulin-like growth factor binding protein  
3 ratio

IGF-IR – Insulin-like growth factor I receptor

IR – Insulin receptor

SS – Somatostatin

WHR – Waist to hip ratio

OT – Overtraining

OTS – Overtraining syndrome

PAR-Q – Physical Activity Readiness Questionnaire

POMS – Profile of mood state

**APPENDIX B**  
**SUBJECT FORMS**

## APPENDIX B

### Subject Forms

#### INFORMATION AND CONSENT

##### **The utility of IGF-I and IGFBP-3 as markers of training status in elite athletes**

Name\_\_\_\_\_ Age\_\_\_\_\_

You are invited to participate in a study involving the effects of training status on the hormonal response to long-term training.

The purpose of this study is to determine the long-term effects of intense exercise training on the circulating levels of the hormone insulin-like growth factor-I (IGF-I) and its dominant binding protein, Insulin-like growth factor Binding Protein-3 (IGFBP-3). We also want to determine if changes in IGF-I or IGFBP-3 are associated with training status or with symptoms of overtraining. The main researcher for this study is Troy Bischler who is a Graduate Student in the Department of Kinesiology at the University of Lethbridge. He is supervised by Dr. Jennifer Copeland.

As a participant in this study you will be required to complete 2 medical/health questionnaires to ensure it is safe for you to complete all the testing. The study involves three testing phases over 4 months. The first phase will occur in September at the start of your season, the second will occur in mid-October and the third and final phase will occur in December at the end of this semester.

At each of these three phases the testing procedures are identical and consist of the following:

- training status questionnaire
- 3 day food record
- 2 fasting blood samples
- heart rate and blood pressure measurement
- body composition assessment
- maximal aerobic power test
- maximal lactate
- time trial

A short description of each procedure will follow.

## **TRAINING STATUS QUESTIONNAIRE**

During each phase of testing you will be required to complete a standardized training status questionnaire. The questionnaire consists of 54 straightforward “yes/no” questions.

## **3-DAY FOOD RECORD**

For three days prior to testing you will be required to record everything you eat including amounts, types and brands. You do not need to alter your typical eating patterns in any way.

## **HEART RATE AND BLOOD PRESSURE MEASUREMENT**

Both heart rate and blood pressure measurements are taken as a precaution before exercise testing. These measurements assist in the evaluation of an individual’s health and fitness status. Heart rate will also be measured during the aerobic power test using a Polar heart rate monitor. Maximal heart rate will be determined following the termination of the maximal aerobic power test.

## **BODY COMPOSITION ASSESSMENT (~15 minutes)**

The body composition assessment will include measurements of height, weight and skinfolds. Skinfolds will be taken on 7 sites on your body using a skinfold caliper. The procedure is painless and quick.

## **MAXIMAL AEROBIC POWER TEST (VO<sub>2</sub>MAX) (~ 30 minutes including warm-up and cool down)**

The VO<sub>2</sub>max test involves a maximal graded treadmill test. You will run at a constant rate (typically 6-8mph), while the grade will be increased every 2 minutes until exhaustion. During this test you will be using a mouthpiece apparatus connected to a metabolic cart in order to measure your oxygen consumption.

## **MAXIMAL LACTATE MEASUREMENT (~2 minutes)**

The maximal lactate measurement will be taken upon the termination of the maximal aerobic test. A fully trained individual will take a finger prick blood sample and analyze it for lactate concentration using a portable lactate analyzer.

## **RESTING BLOOD SAMPLES (~15 minutes)**

A blood sample will be drawn on two mornings of each phase, for a total of 6 samples throughout the study. Approximately 10ml of blood from a vein in your arm will be taken by a fully trained individual. There will be strict pre-testing guidelines, which include no eating for 12 hours prior to testing. Also, you will be asked to refrain from strenuous physical activity for 24 hours prior to sampling.

## **TIME TRIAL**

During a team practice prior to the beginning of each testing phase, each subject will perform a time trial. Your dominant event will be timed and will continue to be timed for

all three phases. The warm-up, distance, stroke, and timing procedures will be standardized throughout the study.

### **POTENTIAL RISKS**

Blood sampling may cause some minor discomfort. The samples will be taken under sterile conditions by a trained individual and no complications resulting from blood sampling have ever occurred in this laboratory. Both the time trial and the graded treadmill test that will be used in the study require maximal effort, and as such, you may experience some fatigue, nausea, dizziness or lightheadedness. These are normal and expected sensations for maximal exercise and typically resolve quickly with active recovery. The testing will be performed under the supervision of a certified Professional Fitness and Lifestyle Consultant who is also certified in CPR and First Aid.

### **BENEFITS**

The results of this research may identify a physiological marker to diagnose overtraining syndrome (OTS). This would be beneficial for elite athletes and coaches as it may allow early detection of OTS so that appropriate preventive measures can be taken.

The fitness testing in this study will also allow you to monitor your training status and performance over the course of the semester. These test results would normally be expensive to obtain, however, you will receive your test results at no cost. This may be beneficial to your athletic performance.

### **RESULTS**

Upon the completion of the study an appointment can be made with the principal investigator to obtain and discuss your results if desired.

### **ANTICIPATED USE OF THE DATA**

The intended use of the data collected from this study is to publish the finding of the study. If used in publication, your identity will remain anonymous.

If you have questions about this research please contact the Principal Investigator:

Troy Bischler  
Dept. of Kinesiology  
University of Lethbridge  
(403) 317-5073  
(403) 380-1839 (f)  
troy.bischler@uleth.ca

Questions regarding your rights as a participant in this research may be addressed to the Office of Research Services, University of Lethbridge (Phone: 403-329-2747)

### **CONSENT**

I acknowledge that:

- Based on my knowledge there is no medical reason why I cannot perform the testing as described
- I have completed a PAR-Q and none of my responses were “yes”
- I have reported any medication that I am taking
- the researchers have answered all my questions
- I understand the potential risks and benefits of this experiment
- my results will be provided to me upon completion of all testing, if I desire.
- all of my results, both medical and performance, will be kept strictly confidential and if used for publication, my identity will remain anonymous
- I recognize that my involvement is voluntary and I may discontinue the testing at any time without penalty or any negative consequences.
- I agree to inform the researcher if my health condition changes or if I begin taking any medication while I am involved with this study.

I have read the above statements and understand the conditions of my participation in this study.

Signature: \_\_\_\_\_

Date: \_\_\_\_\_

Signature of researcher: \_\_\_\_\_

Date: \_\_\_\_\_



# PAR-Q & YOU

(A Questionnaire for People Aged 15 to 69)

Regular physical activity is fun and healthy, and increasingly more people are starting to become more active every day. Being more active is very safe for most people. However, some people should check with their doctor before they start becoming much more physically active.

If you are planning to become much more physically active than you are now, start by answering the seven questions in the box below. If you are between the ages of 15 and 69, the PAR-Q will tell you if you should check with your doctor before you start. If you are over 69 years of age, and you are not used to being very active, check with your doctor.

Common sense is your best guide when you answer these questions. Please read the questions carefully and answer each one honestly: check YES or NO.

YES	NO	
<input type="checkbox"/>	<input type="checkbox"/>	1. Has your doctor ever said that you have a heart condition <u>and</u> that you should only do physical activity recommended by a doctor?
<input type="checkbox"/>	<input type="checkbox"/>	2. Do you feel pain in your chest when you do physical activity?
<input type="checkbox"/>	<input type="checkbox"/>	3. In the past month, have you had chest pain when you were not doing physical activity?
<input type="checkbox"/>	<input type="checkbox"/>	4. Do you lose your balance because of dizziness or do you ever lose consciousness?
<input type="checkbox"/>	<input type="checkbox"/>	5. Do you have a bone or joint problem (for example, back, knee or hip) that could be made worse by a change in your physical activity?
<input type="checkbox"/>	<input type="checkbox"/>	6. Is your doctor currently prescribing drugs (for example, water pills) for your blood pressure or heart condition?
<input type="checkbox"/>	<input type="checkbox"/>	7. Do you know of <u>any other reason</u> why you should not do physical activity?

If  
you  
answered

## YES to one or more questions

Talk with your doctor by phone or in person BEFORE you start becoming much more physically active or BEFORE you have a fitness appraisal. Tell your doctor about the PAR-Q and which questions you answered YES.

- You may be able to do any activity you want — as long as you start slowly and build up gradually. Or, you may need to restrict your activities to those which are safe for you. Talk with your doctor about the kinds of activities you wish to participate in and follow his/her advice.
- Find out which community programs are safe and helpful for you.

## NO to all questions

If you answered NO honestly to all PAR-Q questions, you can be reasonably sure that you can:

- start becoming much more physically active — begin slowly and build up gradually. This is the safest and easiest way to go.
- take part in a fitness appraisal — this is an excellent way to determine your basic fitness so that you can plan the best way for you to live actively. It is also highly recommended that you have your blood pressure evaluated. If your reading is over 144/94, talk with your doctor before you start becoming much more physically active.

### DELAY BECOMING MUCH MORE ACTIVE:

- if you are not feeling well because of a temporary illness such as a cold or a fever — wait until you feel better; or
- if you are or may be pregnant — talk to your doctor before you start becoming more active.

**PLEASE NOTE:** If your health changes so that you then answer YES to any of the above questions, tell your fitness or health professional. Ask whether you should change your physical activity plan.

**Informed Use of the PAR-Q:** The Canadian Society for Exercise Physiology, Health Canada, and their agents assume no liability for persons who undertake physical activity, and if in doubt after completing this questionnaire, consult your doctor prior to physical activity.

**No changes permitted. You are encouraged to photocopy the PAR-Q but only if you use the entire form.**

NOTE: If the PAR-Q is being given to a person before he or she participates in a physical activity program or a fitness appraisal, this section may be used for legal or administrative purposes.

"I have read, understood and completed this questionnaire. Any questions I had were answered to my full satisfaction."

NAME \_\_\_\_\_

SIGNATURE \_\_\_\_\_

SIGNATURE OF PARENT  
or GUARDIAN (for participants under the age of majority) \_\_\_\_\_

DATE \_\_\_\_\_

WITNESS \_\_\_\_\_

**Note: This physical activity clearance is valid for a maximum of 12 months from the date it is completed and becomes invalid if your condition changes so that you would answer YES to any of the seven questions.**



© Canadian Society for Exercise Physiology

Supported by:



Health  
Canada

Santé  
Canada

continued on other side...

# PAR-Q & YOU

Physical Activity Readiness Questionnaire - PAR-Q (revised 2002)

...continued from other side

**Physical Activity Guide to Healthy Active Living**

**Physical activity improves health.**

Every little bit counts, but more is even better – everyone can do it!

Get active your way – build physical activity into your daily life...

- at home
- at school
- at work
- at play
- on the way
- that's active living!

**Endurance**  
4-7 days a week  
Continuous activities for your heart, lungs and circulatory system.

**Flexibility**  
4-7 days a week  
Gentle stretching, bending and stretching activities to keep your muscles relaxed and joints mobile.

**Strength**  
2-4 days a week  
Activities against resistance to strengthen muscles and bones and improve posture.

Starting slowly is very safe for most people. Not sure? Consult your health professional.

For a copy of the Guide Handbook and more information: 1-800-226-9769, or [www.paguide.com](http://www.paguide.com)

Eating well is also important. Follow Canada's Food Guide to Healthy Eating to make wise food choices.

**Benefits of regular activity:**

- Delayed ageing
- Improved flexibility
- Better posture and balance
- Better coordination
- Weight control
- Better mood and stress
- Healthy weight management
- Reduced risk of chronic disease
- Continued independence living in later life

**Health risks of inactivity:**

- Increased blood pressure
- Increased cholesterol
- High blood pressure
- Increased risk of heart disease
- Stroke
- Diabetes
- Osteoporosis

**Goals to stay healthy:**

- 150 minutes of moderate activity per week
- 75 minutes of vigorous activity per week
- 2-4 days of strength training per week
- 2-4 days of flexibility training per week

**Goals to stay healthy:**

- 10-15 minutes of walking per day
- 5-10 minutes of stretching per day
- 1-2 days of strength training per week
- 1-2 days of flexibility training per week

## Get Active Your Way, Every Day—For Life!

Scientists say accumulate 60 minutes of physical activity every day to stay healthy or improve your health. As you progress to moderate activities you can cut down to 30 minutes, 4 days a week. Add-up your activities in periods of at least 10 minutes each. Start slowly... and build up.

### Time needed depends on effort

Very Light Effort	Light Effort	Moderate Effort	Vigorous Effort	Maximum Effort
• walking	• light walking	• brisk walking	• jumping	• sprinting
• walking	• jogging	• cycling	• hiking	• racing
	• raking leaves	• swimming	• tennis	
	• mowing	• dancing	• basketball	
	• water aerobics	• curling	• ice skating	
		• roller skating	• rowing	

**Range needed to stay healthy**

### You Can Do It – Getting started is easier than you think!

Physical activity doesn't have to be very hard. Build physical activities into your daily routine.

- Walk whenever you can – get off the bus early, use the stairs instead of the elevator.
- Reduce inactivity for long periods, like watching TV. Get up from the couch and stretch and bend for a few minutes every hour.
- Play actively with your kids.
- Choose to walk, wheel or cycle for short trips.
- Start with a 10 minute walk – gradually increase the time.
- Find out about walking and cycling paths nearby and use them.
- Observe a physical activity class to see if you want to try it.
- Try one class to start – you don't have to make a long-term commitment.
- Do the activities you are doing now, more often.

### Benefits of regular activity:

- Delayed ageing
- Improved flexibility
- Better posture and balance
- Better coordination
- Weight control
- Better mood and stress
- Healthy weight management
- Reduced risk of chronic disease
- Continued independence living in later life

### Health risks of inactivity:

- Increased blood pressure
- Increased cholesterol
- High blood pressure
- Increased risk of heart disease
- Stroke
- Diabetes
- Osteoporosis



Source: Canada's Physical Activity Guide to Healthy Active Living, Health Canada, 1998 <http://www.hc-sc.gc.ca/hppb/paguide/pdf/guideEng.pdf>

© Reproduced with permission from the Minister of Public Works and Government Services Canada, 2002.

### FITNESS AND HEALTH PROFESSIONALS MAY BE INTERESTED IN THE INFORMATION BELOW:

The following companion forms are available for doctors' use by contacting the Canadian Society for Exercise Physiology (address below):

The **Physical Activity Readiness Medical Examination (PARmed-X)** – to be used by doctors with people who answer YES to one or more questions on the PAR-Q.

The **Physical Activity Readiness Medical Examination for Pregnancy (PARmed-X for Pregnancy)** – to be used by doctors with pregnant patients who wish to become more active.

#### References:

- Arraix, G.A., Wigle, D.T., Mao, Y. (1992). Risk Assessment of Physical Activity and Physical Fitness in the Canada Health Survey Follow-Up Study. *J. Clin. Epidemiol.* 45:4 419-428.
- Mottola, M., Wolfe, L.A. (1994). Active Living and Pregnancy. In: A. Quinney, L. Gauvin, T. Wall (eds.), **Toward Active Living: Proceedings of the International Conference on Physical Activity, Fitness and Health**. Champaign, IL: Human Kinetics.
- PAR-Q Validation Report, British Columbia Ministry of Health, 1978.
- Thomas, S., Reading, J., Shephard, R.J. (1992). Revision of the Physical Activity Readiness Questionnaire (PAR-Q). *Can. J. Sport Sci.* 17:4 338-345.

For more information, please contact the:

Canadian Society for Exercise Physiology  
202-185 Somerset Street West  
Ottawa, ON K2P 0J2  
Tel. 1-877-651-3755 • FAX (613) 234-3565  
Online: [www.csep.ca](http://www.csep.ca)

The original PAR-Q was developed by the British Columbia Ministry of Health. It has been revised by an Expert Advisory Committee of the Canadian Society for Exercise Physiology chaired by Dr. N. Gledhill (2002).

Disponible en français sous le titre «Questionnaire sur l'aptitude à l'activité physique - Q-AAP (révisé 2002)».



© Canadian Society for Exercise Physiology

Supported by:



Health Canada Santé Canada

## HEALTH SCREENING FORM

The purpose of this form is to get some information about your medical and health history. This is to ensure that you do not have any medical or health problems that are contraindications to the testing.

Name : \_\_\_\_\_ Date: \_\_\_\_\_

Address:

---

---

Phone (home): \_\_\_\_\_ Medicare: \_\_\_\_\_

Family Physician: \_\_\_\_\_

---

### GENERAL SCREENING

1. Have you answered "yes" to any of the questions on the PAR-Q?
2. Do you have any allergies? If so, to what?

### MEDICAL HISTORY

3. Please identify if you have had any of the following health problems:

- |                        |     |    |
|------------------------|-----|----|
| a) high blood pressure | yes | no |
| b) heart trouble       | yes | no |
| c) diabetes            | yes | no |
| d) asthma              | yes | no |
| e) epilepsy            | yes | no |
| f) thyroid disorder    | yes | no |

- |                              |     |    |
|------------------------------|-----|----|
| g) any disease of the glands | yes | no |
| h) rheumatic fever           | yes | no |
| I) arthritis, rheumatism     | yes | no |
| j) kidney disease            | yes | no |
| k) fainting/syncope          | yes | no |
| l) other _____               |     |    |

4. Have you ever had any musculoskeletal problems (injuries to bones, muscles, joints)? If so, describe the problem. Are you currently having any musculoskeletal problems? If so, what?
  
5. Have you ever been injured in an accident? If so, how?
  
6. Have you ever been advised for medical reasons not to participate in physical activity? If so, when? Why?
  
7. Are you taking any medications at present (including hormone contraceptives)? If so, please provide the name of the medication.
  
8. Are you taking any herbal preparations or non-prescription medications not listed above? If so, what?

9. Do you smoke? If so, how much?
  
10. Is there any other medical information that you think may be important to your participation in this study?

## TRAINING HISTORY FORM

The purpose of this form is to obtain information regarding your training history.

Name: \_\_\_\_\_

1. How long have you been swimming competitively?
2. On average, how many times a week do you train in the pool?
3. What is your average volume (meters) per training session?
4. On average how many time per week do you train away from the pool?
5. How many years have you been training with a varsity swim team?
6. Do you train competitively for any other sport?

**Overtraining Questionnaire**  
(French Society of Sports Medicine)

Sex:	M	F
Date of Birth:		
Are you currently doing examinations?	Y	N
What is your main sport or game?		
How many hours a week do you practice?	6-8	8-10 11+
If you play any other sports or games, please write them:		
This month, has there been any significant event which may have disturbed your private or professional life?	Y	N
This month		
1-My level of sports performance/my general form has decreased	Y	N
2- I am not as attentive as before	Y	N
3- My close friends think my behavior has changed	Y	N
4-I have a sensation of pressure in my chest	Y	N
5-My heart seems to beat faster	Y	N
6-I have a lump in my throat	Y	N
7-I have less of an appetite then before	Y	N
8-I eat more	Y	N
9-I do not sleep as well as before	Y	N
10-I drowse and yawn in the daytime	Y	N
11-The time between training sessions seems to me too short	Y	N
12-My sexual libido has decreased	Y	N
13-My performances are poor	Y	N
14-I frequently catch a cold	Y	N
15-I have put on weight	Y	N
16-I have memory problems	Y	N
17-I often feel tired	Y	N
18-I underestimate myself	Y	N
19-I often have cramps, muscular pain	Y	N
20-I suffer from headaches more frequently	Y	N
21-I do not feel fit	Y	N
22-I sometimes feel dizzy, on the point of fainting	Y	N
23-I do not confide in others so easily	Y	N
24-I often feel seedy	Y	N
25-I have a sore throat more often	Y	N
26-I feel nervous, insecure, anxious	Y	N
27-I do not bear training so well	Y	N
28-At rest, my heart rate is faster than before	Y	N

29-During exercise, my heart rate is faster than before	Y	N
30-I often feel rotten	Y	N
31-I get tired more easily	Y	N
32-I often have digestive disorders	Y	N
33-I feel like staying in bed	Y	N
34-I am not so confident in myself	Y	N
35-I get injured more easily	Y	N
36-I have more difficulties in organizing my thoughts	Y	N
37-I have more difficulties in concentrating in my sports activity	Y	N
38-My sporting gestures are less precise, less skillful	Y	N
39-I have lost force and aggressiveness	Y	N
40-I feel as if I have no one to talk to	Y	N
41-I sleep longer	Y	N
42-I cough more often	Y	N
43-I do not enjoy practicing my sports as much	Y	N
44-I do not enjoy my leisure activities as much	Y	N
45-I get irritated more easily	Y	N
46-I am less efficient in my school or professional activity	Y	N
47-People around me think that I have become less available	Y	N
48-Training seems harder and harder	Y	N
49-It is my fault if my results are worse	Y	N
50-My legs feel heavy	Y	N
51-I lose my personal things more easily (wallet, keys, etc.)	Y	N
52-I am pessimistic, I have the blues	Y	N
53-I have lost weight	Y	N
54-My motivation, will and tenacity are weaker	Y	N

Put a cross to indicate where you fall in the range between these two opposite states

My physical level

Great form\_\_\_\_\_Bad form  
I feel fatigued  
More slowly\_\_\_\_\_More quickly  
I recover from my state of tiredness  
More quickly\_\_\_\_\_More slowly  
I feel  
Very relaxed\_\_\_\_\_Very anxious  
I feel that my muscular strength has  
Increased\_\_\_\_\_Decreased  
I feel that my endurance has  
Increased\_\_\_\_\_Decreased

Did you have any difficulties in understanding some of the questions? Y N

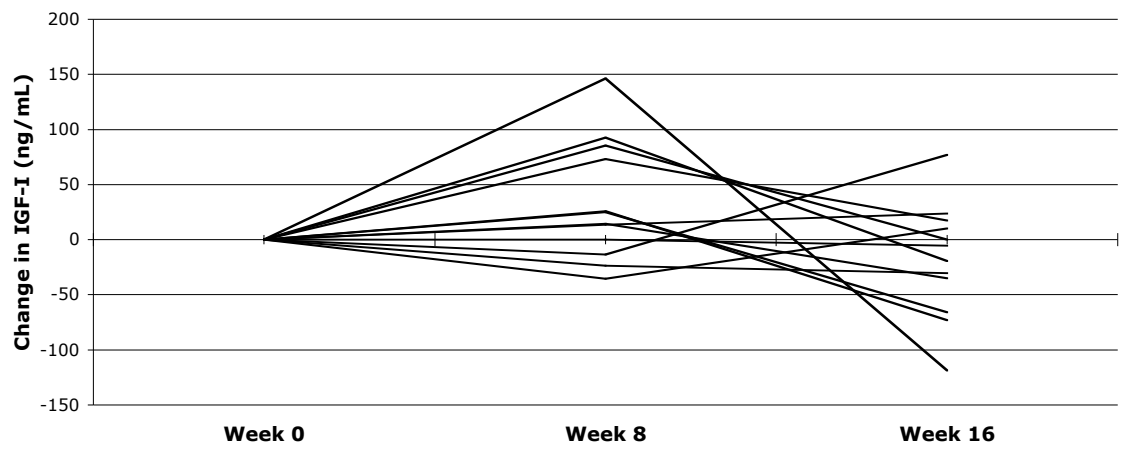




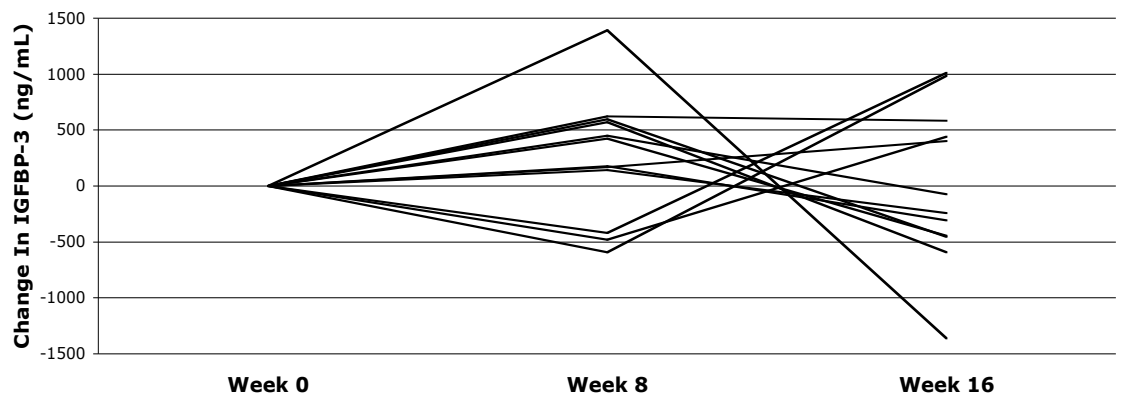
**APPENDIX C**  
**INDIVIDUAL HORMONE CONCENTRATIONS**

**Table 9. Individual data for IGF-I and IGFBP-3 concentrations and IGF-I/IGFBP-3 ratio across all testing phases.**

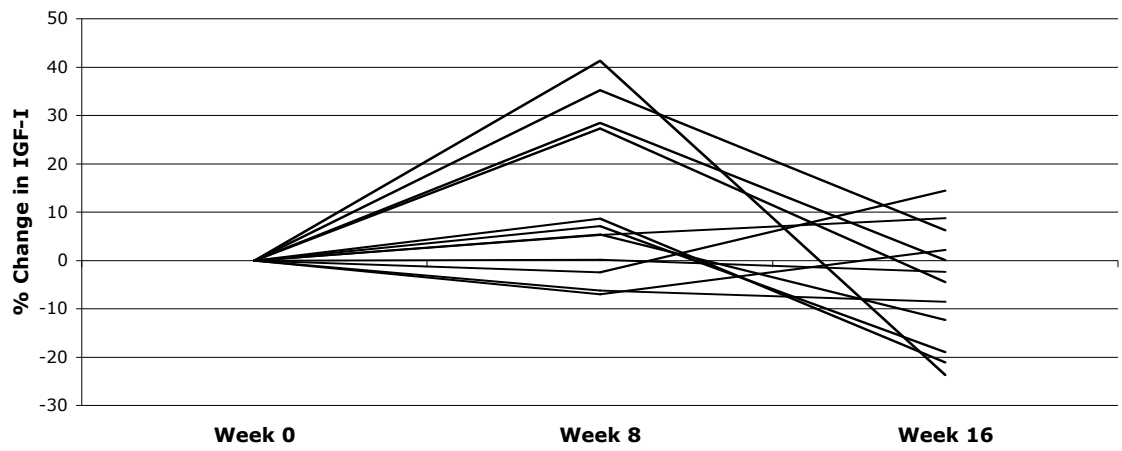
Subject	Session	IGF-I ng/mL	IGFBP-3 ng/mL	IGF-I/IGFBP-3 ng/mL
1	Week 0	379.3	4074	9.3
	Week 8	355.7	4523.9	7.9
	Week 16	325.5	4448.6	7.3
2	Week 0	230.3	3648.7	6.3
	Week 8	230.6	4245.2	5.4
	Week 16	225	3789.7	5.9
3	Week 0	501.6	5000.9	10
	Week 8	466.3	5143.2	9.1
	Week 16	476.4	4900.3	9.7
4	Week 0	353.6	4211.7	8.4
	Week 8	499.8	4782.9	10.4
	Week 16	381.1	4191.9	9.1
5	Week 0	269.3	3537.5	7.6
	Week 8	283.8	3961.3	7.2
	Week 16	248.8	3518.2	7.1
6	Week 0	207.9	4820.8	4.3
	Week 8	281.1	4400.4	6.4
	Week 16	298.7	5411.2	5.5
7	Week 0	299.8	5873.1	5.1
	Week 8	385.5	7266.4	5.3
	Week 16	385.4	5904.1	6.5
8	Week 0	338.8	4596.5	7.4
	Week 8	431.4	5220.1	8.3
	Week 16	411.8	5805.3	7.1
9	Week 0	298	4940.3	5.8
	Week 8	300.9	5119.2	6.1
	Week 16	247.3	4813.8	5.1
10	Week 0	257.3	6536.2	3.9
	Week 8	271	6057.9	4.5
	Week 16	294.7	6498.3	4.5
11	Week 0	547.5	6897	7.9
	Week 8	534	6304.6	8.5
	Week 16	611.1	7291.5	8.4
12	Week 0	360.7	4481.1	8.1
	Week 8	386.4	4648.9	8.3
	Week 16	313.2	5051.7	6.2
Mean SD±	Week 0	336.2 ± 103	4884.8 ± 1064.86	7.0 ± 1.9
	Week 8	369.9 ± 97.8	5139.5 ± 963.51	7.3 ± 1.8
	Week 16	351.6 ± 110.5	5135.4 ± 1110.93	6.9 ± 1.6



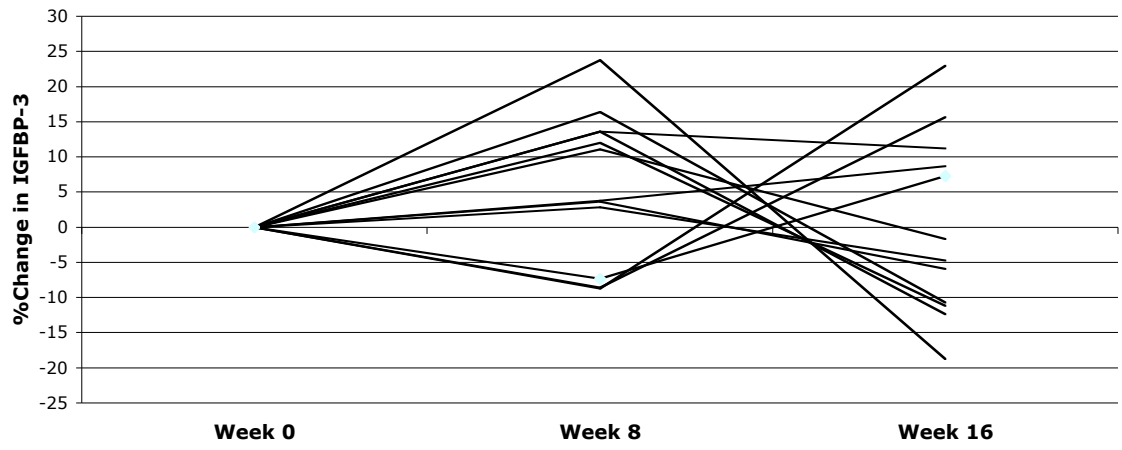
**Figure 18. Individual data for absolute change in IGF-I across time.**



**Figure 19. Individual data for absolute change in IGFBP-3 across time.**



**Figure 20. Individual data for percent change in IGF-I across time.**



**Figure 21. Individual data for percent change in IGFBP-3 across time.**

**APPENDIX D**  
**REFERENCE RANGES**

## APPENDIX D

### Reference Ranges

<u>Hormone</u>	<u>Range</u>
IGF-I	49 – 550 ng/mL
IGFBP-3	1500 – 5580 ng/mL

Diagnostic Systems Laboratories Inc., TX., USA

**APPENDIX E**

**IGF-I AND IGFBP-3 ASSAY PROCEDURES**



## APPENDIX E

### Hormone Assay Procedures

**Table 10. Enzyme-linked Immunosorbent Assay procedures for analysis of serum IGF-I and IGFBP-3**

<b>IGF-I</b>	<b>IGFBP-3</b>
1. Mark microtitration strips to be used	1. Mark microtitration strips to be used
2. Pipet 20uL of each standard, control and pretreated unknown to appropriate wells.	2. Pipet 25uL of each standard, control and pretreated unknown to appropriate wells.
3. Add 100uL of the assay buffer to each well using a semi-automatic dispenser.	3. Add 50 uL of the assay buffer to each well using a semi-automatic dispenser.
4. Incubate the wells, shaking at a fast speed (500-600rpm) on an orbital microplate shaker for 2 hours at room temperature.	4. Incubate the wells, shaking at a fast speed (500-600rpm) on an orbital microplate shaker for 2 hours at room temperature.
5. Aspirate and wash each well five times with the wash solution using an automatic microplate washer.	5. Aspirate and wash each well five times with the wash solution using an automatic microplate washer.
6. Prepare the antibody-enzyme conjugate solution.	6. Prepare the antibody-enzyme conjugate solution.
7. Add 100uL of the antibody-enzyme conjugate solution to each well using a semi-automatic dispenser.	7. Add 100uL of the antibody-enzyme conjugate solution to each well using a semi-automatic dispenser.
8. Incubate the wells, shaking at a fast speed (500-600 rpm) for 30 minutes.	8. Incubate the wells, shaking at a fast speed (500-600 rpm) for 1 hour.
9. Aspirate and wash each well five times with the wash solution using an automatic microplate washer.	9. Aspirate and wash each well five times with the wash solution using an automatic microplate washer.
10. Add 100uL of the TMB chromogen solution to each well using a semi-automatic dispenser.	10. Add 100uL of the TMB chromogen solution to each well using a semi-automatic dispenser.
11. Incubate the wells, shaking at a fast speed (500-600 rpm) for 10 minutes.	11. Incubate the wells, shaking at a fast speed (500-600 rpm) for 10 minutes.
12. Add 100uL of the stopping solution to each well using a semi-automatic dispenser.	12. Add 100uL of the stopping solution to each well using a semi-automatic dispenser.
13. Read the absorbance of the solution in the wells within 30 minutes, using a microplate reader set to 450nm.	13. Read the absorbance of the solution in the wells within 30 minutes, using a microplate reader set to 450nm.