

**NEURAL CHANGES IN FORELIMB CORTEX AND BEHAVIOURAL  
DEVELOPMENT**

**BRENDA L. K. COLES**

**(Bachelor of Science, University of Lethbridge, 1993)**

**A Thesis**

**Submitted to the Council on Graduate Studies  
of the University of Lethbridge  
in Partial Fulfilment for  
Requirements for the Degree**

**MASTER OF SCIENCE**

**UNIVERSITY OF LETHBRIDGE**

**LETHBRIDGE, ALBERTA**

**December, 1996**

**© Brenda L. K. Coles, 1996**

## DEDICATION

This thesis is dedicated to my family since without them (literally and figuratively) I would not have made it this far.

### **ABSTRACT**

Neural changes in the forelimb cortex were studied at Postnatal (P) 10, 15, 20, 25, 30, and 100 days. Six biological markers of brain development, cortical thickness, Layer III pyramidal cell morphology, glial fibrillary acidic protein (GFAP), myelination, c-fos activity and Acetylcholinesterase (AChE) were correlated with the behavioural development of reaching, bimanual coordination, postural adjustment, and defensive feeding behaviours. The behaviours were filmed from P15 until P30 and then also in adulthood. For the behaviours there was a gradual development of the skilled patterns of paw and digit use seen in adults as well as in the patterns of movements in postural adjustment, carry behaviours and dodging and robbing type behaviours. The development of the adult patterns of movement were correlated to the morphological and biochemical changes in the cortex. The results suggest that the maturation of skilled movements depends upon anatomical and neurochemical maturation of the neocortex as well as upon learning.

## ACKNOWLEDGEMENTS

My supervisor and mentor Ian Whishaw for giving me the chance to prove myself and for always being there when I needed help.

Robbin Gibb for sharing your knowledge and skills and for the many countless hours you spent teaching me.

Sergio Pellis for always being enthusiastic about my project, giving me advice and helping me keep on track.

Bogdan Gorny for the great technical advice and for having the best music collection around.

Grazyna Gorny the best neuron drawer in the world and for willing to teach me how to find and draw the elusive FL pyramidal neurons.

Reed Kindt for using your artistic talent for drawing the bimanual coordination, and eating posture figures (they are amazing).

Bryan Kolb thanks for letting me be part of your lab and for being so understanding when I kept your technicians from their work. But most of all thanks for introducing me to the finer things in life.

Dr. Forgie for the Golgi-Cox developmental slides.

I also wish to acknowledge and thank the other people who have helped me out over the last couple of years: Lori Smith, Karen Cazal, Glen Prusky, Evelyn Field and the many students who have wandered in and out of the labs whose new perspectives helped me in my own research.

## TABLE OF CONTENTS

|  |     |
|--|-----|
| Title Page.....                                    | i   |
| Signature Page.....                                | ii  |
| Dedication.....                                    | iii |
| Abstract.....                                      | iv  |
| Acknowledgements.....                              | v   |
| Table of Contents.....                             | vi  |
| List of Figures.....                               | vii |
| List of Abbreviations.....                         | ix  |
| Chapter 1: General Introduction.....               | 1   |
| Research Approach.....                             | 24  |
| Chapter 2: Behavioural Development.....            | 31  |
| Chapter 3: Biochemical Markers of Development..... | 67  |
| Chapter 4: General Discussion.....                 | 113 |
| References.....                                    | 120 |

## LIST OF FIGURES

| Figure | Description                                      | Page |
|--------|--|------|
| 1.     | Brain & Behaviour                                | 2    |
| 2.     | Cortical development                             | 10   |
| 3.     | Neurogenetic theory                              | 12   |
| 4.     | Cortical layering                                | 14   |
| 5.     | Behavioural apparatus                            | 34   |
| 6.     | Pictorial demonstration of dodging & robbing     | 37   |
| 7.     | Pictorial demonstration of carry behaviour       | 39   |
| 8.     | Pictorial demonstration of reaching              | 41   |
| 9.     | Pictorial demonstration of bimanual coordination | 42   |
| 10.    | Pictorial demonstration of eating posture        | 44   |
| 11.    | See-saw behaviour in a juvenile rat              | 46   |
| 12.    | Dodging & robbing in juvenile rats               | 50   |
| 13.    | Carry-to-eat behaviour                           | 53   |
| 14.    | Reaching for chicken feed                        | 54   |
| 15.    | Precision reaching                               | 57   |
| 16.    | Bimanual coordination using angelhair pasta      | 58   |
| 17.    | Quantification of behavioural maturity           | 61   |
| 18.    | Behavioural Timeline summary                     | 62   |
| 19.    | FL Area and measuring cortical thickness         | 76   |
| 20.    | How to measure Sholl & Branch Order              | 78   |
| 21.    | FL Area and measuring using stereology           | 79   |
| 22.    | Cortical thickness graph                         | 86   |

|  |     |
|--|-----|
| 23. Picture of Nissl stain of FL Area  | 87  |
| 24. Picture of Golgi Stain of pyramidal neurons  | 89  |
| 25A. Graph of Sholl analysis on Apical dendrites   | 90  |
| 25B. Graph of Sholl analysis on Basilar dendrites  | 91  |
| 26. Graph of Branch Order analysis of neurons  | 93  |
| 27. Camera Lucida drawings of Layer III pyramidal neurons  | 94  |
| 28. Graph of GFAP - immunoreactivity   | 96  |
| 29. Picture of GFAP-immunoreactivity   | 97  |
| 30. Picture of Myelin staining   | 99  |
| 31. Graphs showing development of myelination  | 101 |
| 32. Graph of c-fos immunoreactivity  | 103 |
| 33. Picture of c-fos immunoreactivity  | 104 |
| 34. Graph of AChE activity   | 106 |
| 35. Picture of AChE activity   | 107 |
| 36. Summary of Biochemical marker expression   | 109 |
| 37. Graphic representation of the relationship<br>between biochemical markers and<br>behavioural development | 117 |

## LIST OF ABBREVIATIONS

ABC: avidin and biotinylated horseradish peroxidase macromolecular complex

ac: anterior commissure

ACh: Acetylcholine

AChE: Acetylcholinesterase

cc: corpus callosum

c-fos: cellular

CPu: Caudate Putamen

DAB: 3,3<sup>I</sup>-diaminobenzidine

E(#): Embryonic day

FL: Forelimb area of the motor cortex

FR: Frontal area

GFAP: Glial Fibrillary Acidic Protein

HL: Hindlimb area of the motor cortex

iso-OMPA: tetraisopropylpyrophosphoramidate

P(#): Postnatal day

PB: Phosphate Buffer

PBS: Phosphate Buffered Saline

S.E.M.: Standard Error Mean



## Chapter 1: Introduction

### Neuropsychology

Neuropsychology is the study of the relation between brain structure and function (Fig. 1). The main objective is to localize and define what areas or systems in the brain are responsible for discrete behaviours. Over the last few centuries the methods of studying the brain have improved considerably with the changes in technology and the discoveries that were made possible with them.

The brain was thought to be a gland until the 1700's when the discovery of the compound microscope led to findings that show that the brain is not just a mass of fused cells, but is an intricate network of highly specialized cells. Camillo Golgi and Santiago Ramón y Cajal, towards the end of the 1800's, made the study of neurons using histological methods precise, primarily through Golgi's silver impregnation method that allowed the microscopic visualization of the entire neuron possible. Cajal used this technique to stain individual neurons and was the first person to give support to the neuron hypothesis which states that: the nervous system is composed of individual signalling elements, the neurons, which contact one another only at specialized points of interaction, ie. the synapses (Kandel, Schwartz & Jessell, 1991). By characterizing the neurons and other cells in the brain, the capability to understand the way the brain controls behaviour can be studied at a more sophisticated level.

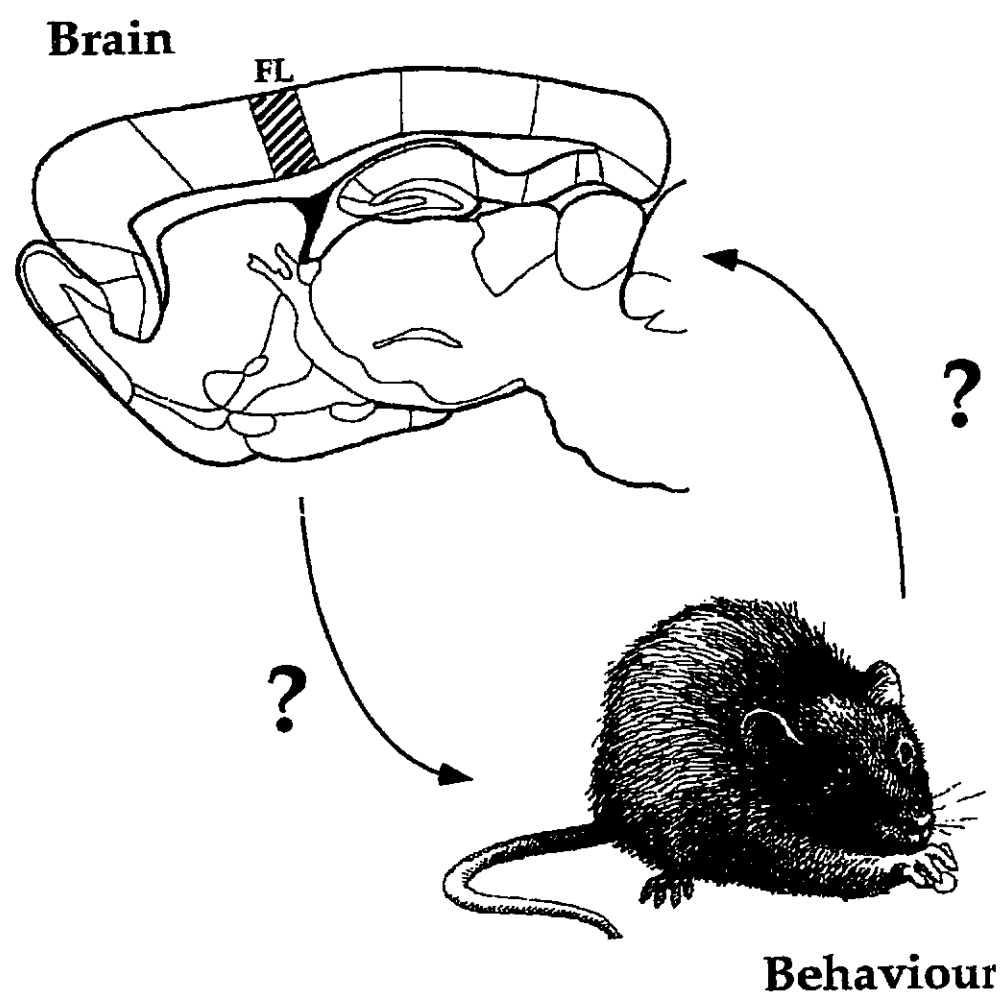

**Figure 1.** Brain & Behaviour. What is the relationship between development of the brain and development of motor behaviour? (FL-Forelimb area of the motor cortex).

### **Localization of Function**

The hypothesis that the brain is the source of behaviour, ie. the brain hypothesis, has been dominant since Franz Joseph Gall in the early 1800's argued that the mind must have a biological basis and its functions are carried out by the brain (Young, 1970). He divided the brain up into 35 areas and assigned each area a specific mental function. He also was the first to hypothesize that each area could increase or decrease in size depending on use. Gall pointed out that there was no scientific basis for the theory of cerebral localization of behaviour and devised the first empirical approach to the study of brain and behaviour. The discipline that emerged from the ideas of Franz Gall and his colleague Johann Spurzheim was named phrenology, a study that attempted to associate the higher brain functions such as intellect and emotions with bumps and ridges on the human skull. Pierre Flourens (1794 - 1867) opposed the hypothesis that different functions are localized in the cerebral cortex; instead he believed that the cortex was a functionally indivisible organ that produced all behaviour. Utilizing experimental methodology, Flourens made systematic ablations of the cortex and then by recording the behavioural recovery, he concluded that if one cortical function is lost then they all are. Using this experimental evidence he concluded that function was not localized within the cerebral cortex and any area within the cortex was able to perform any given behaviour. Because of Flourens' high status among fellow scientists, and Gall's low one, his arguments against localization of function were well received. This argument led to a major set-back for the idea that neural structure and function could be related. The

irony of Flourens' work is that it was through the more sophisticated use of his experimental techniques that eventually provided the first experimental demonstration that Gall's theory was wrong.

### **Levels of Function**

In the middle of the nineteenth century, Flourens' views on brain function were challenged and dismissed. One of the challengers to his mass action view was Hughlings-Jackson (1835-1911), an English neurologist, who during his clinical studies of epilepsy showed that different motor and sensory activities were localized in different parts of the cerebral cortex (Young, 1970; and Kolb & Whishaw, 1995). Hughlings-Jackson was also the first to conceptualize hierarchical organization. He described the nervous system as being arranged in a number of layers each of which controlled more complex functions. His theory suggested that the brain evolved through a series of steps with each step bringing the ability to engage in new more complex behaviours. He also suggested that the cerebral cortex directly controlled the integration of body movements while individual muscles were controlled by subcortical structures (Jacobson, 1991). For Hughlings-Jackson the frontal cortex mediated the highest levels of function with the brainstem and spinal cord mediating the lowest. He also suggested that injury or disease that affected the highest levels of processing would result in a reverse of evolution. A Jacksonian idea relevant to the present thesis is that during development, the maturation of successively higher levels, ie. from subcortical to cortical, may be related to behavioural development.

### **Localization of Motor Cortex**

Support for the idea of localization of function of the frontal cortex came from the technique of electrical stimulation of the brain. Gustav Theodor Fritsch (1838 - 1929) and Eduard Hitzig (1838 - 1907) used this technique to stimulate the cortex and induce movements of specific parts of the body. They found that the cortex was selectively excitable and that if they stimulated the frontal cortex in one hemisphere the movement was induced in the opposite side of the body in both rabbits and dogs. They were able to prove that the cortex is excitable, that it plays a role in producing movement and that function is localized. David Ferrier (1843 - 1928) refined the stimulation technique and was able to confirm Fritsch and Hitzig's findings in a variety of mammals, birds, fish, and amphibians (Kolb & Whishaw, 1995). During the mid-1900's, Wilder Penfield carried out electrical stimulation experiments in human patients who were undergoing neurosurgery to remove tumours. He stimulated the brain with weak electrical shocks while observing the patients. Through these precise clinical studies, he was able to map the human cortex and represent his findings by constructing a caricature showing each body parts' representation within the somatosensory and motor cortex. He called each complete representation a homunculus (Porter & Lemon, 1993).

### **Function of Motor Cortex**

Elegant brain-behaviour studies on localization in rat and monkey cortex began with the work of Lashley (1920's). Lashley was able to integrate

controlled physiological manipulations with standard quantitative behavioural studies to make inferences on the function of specific brain areas (Young, 1970). It is ironic that Lashley eventually adopted views that were reminiscent of Flourens. Nevertheless, Peterson, Lashley's student, was successful in localizing function in the motor cortex of the rat. He demonstrated that rats could use a single limb to reach for pieces of food. He then used this behaviour to study the effects of motor cortex lesions (Peterson, 1934; Peterson & Fracarol, 1938). Peterson also showed that even small cortical lesions in motor cortex are enough to cause a transfer of handedness to the non-preferred paw (Peterson & Barnett, 1961; Peterson & Devine, 1963). Using this technique, Peterson was able to demonstrate that rats with lesions in one hemisphere are impaired in the forelimb contralateral to the lesion. He showed that the impaired paw is able to relearn forelimb movements of reaching after cortical injuries (Peterson & McGiboney, 1951). His results have now been confirmed and extended in many studies (Whishaw, O'Connor & Dunnett, 1986). Krieg, in the late 1940's, stated that by identifying cortical regions in the rat you could then determine their corresponding areas in primates and from this knowledge make speculations on how human brains work. That skilled movements of the rat are influenced by motor cortex appears to confirm this view.

#### **Developmental Method**

As mentioned above, a Jacksonian view of brain organization suggests that the study of developmental processes can give insights into function. Developmental studies are able to localize the different components of a

behaviour before they are integrated into the mature form and follow their completion into the adult pattern.

Different areas of the brain mature at various rates dependent upon how far they are away from the original neural tube; for example in humans the prefrontal cortex does not complete its development until the late teens or early twenties making it the last brain structure to fully mature (Kolb & Whishaw, 1995). The same developmental pattern is true of all animals. Thus, certain types of behaviours can only be expressed after an important brain area related to that behaviour has become mature (Kolb & Whishaw, 1995). Looking at the nervous system as it matures one can relate anatomy with the subsequent development of specific behaviours. The discipline of developmental neurobiology has attempted to analyze the cortex systematically and to examine how this system is constructed in different stages embryologically and postnatally.

Studies that are able to demonstrate the hierarchical arrangement of cellular connectivity underlying the initial processing of sensory information have primarily been discovered by studying development. David Hubel and Torsten Wiesel were among the first scientists to study and characterize the development of visual cortex. They were able to demonstrate the anatomical basis of vision, that the cortex is arranged in arrays of repeating cortical columns which make up modules that are capable of analyzing small portions of visual space. They also discovered that there is a critical period in which the development of the visual system is susceptible to modification (Purves & Lichtman, 1985).

Through developmental studies of the sensory systems, greater knowledge of how the brain interacts with the environment during growth has given us insights into the principles of neural and behavioural development. The combination of these anatomical studies with behavioural studies has advanced the knowledge of brain function even further over the past century. Additionally, developmental studies that examine biochemical and molecular changes and their relation to behavioural maturation will help us understand the structure - function relationship even more.

#### **The Neurogenetic Hypothesis and Development of Motor Cortex**

An accurate picture of the morphology of rat cortex is made possible with better technology such as microscopes and new staining procedures. With these staining processes, measures for cell packing density, myelin density and morphology of the different cells, the characteristics of the cortex can be distinguished.

The cortical architecture of the brain is constantly changing throughout development and during these changes a pattern emerges dividing the cortex into areas that are morphologically and biochemically very different. According to the neurogenetic hypothesis cortical circuitry is determined in early embryonic development, even before germinal migration has begun (Bayer & Altman, 1987). According to this theory the function of cells are determined prior to birth. The Kennard doctrine, based on young animals recovering from brain damage, suggests that the brain is much more plastic



(see below).

Since this thesis is concerned with the development of motor cortex, a brief description of the organization of the motor cortex is worthwhile. The brain follows a general pattern of development, starting as a neural tube and gradually taking on the characteristics of the adult brain. During development, the cortex is composed of four embryonic regions: the ventricular, marginal, intermediate, and subventricular zones. These zones are transient features uniquely related to early development, since each zone either disappears or becomes altered so that it is no longer recognizable in the adult nervous system. Undifferentiated stem cells are born in gradients so that neuronal precursors are born the earliest and the last cells to be born are fated to be glial cells.

During the formation of the six cortical layers, neurons of layer VI are born around embryonic day 16 (E16), but superficial layers IV through II are born primarily between E17 and E18 thus, establishing an inside-out pattern of development (Fig. 2). There also exists a gradient in the motor cortex from medial to lateral with the medial neurons being younger than the more lateral neurons.

This thesis is concerned with the development of skilled movements, and these are presumed to be mediated by motor cortex. In the rat, motor cortex has a representation of the body which in turn is composed of a large forelimb area (FL) and a more posteriorly located hindlimb area (HL). The forelimb and hindlimb areas of the rat cortex are unique in that there is an overlap of motor and sensorimotor areas which is demonstrated by a reverse

Due to copyright laws Figure 2  
was withdrawn from the manuscript.

in the age gradient of the superficial layers. The superficial layer of forelimb and hindlimb areas are morphologically older than the superficial layers of the frontal areas, but the deep layers still follow the medially younger and laterally older gradient. There also exists a stepwise anterior (older) to posterior (younger) neurogenetic gradient through motor cortex, therefore the most rostral area of the FR2 area is older than the neurons found more caudally (Bayer & Altman, 1991).

The corticospinal tract is the projection from motor cortex to the spinal cord and is thought to contribute to skilled limb movements. Growth of the corticospinal tract follows the same neurogenetic principle of growth: the axons from the cortex terminate an anterior (older) to posterior (younger) pattern, ie. anatomical connections for the forelimbs are mature before the hindlimbs. The overall pattern is for cortical source neurons and spinal cord target neurons to be exactly age-matched with respect to birth and maturation (Fig. 3).

Neurons are comprised of three main parts, a dendritic field that receives input, a cell body that is important for metabolism and an axon through which the cell communicates with other cells. The neuronal packing density is the lowest in the motor cortex, and motor cortex is substantially thicker than cortex in association areas. Motor cortex like all neocortex has six layers, and contains two kinds of cells, glial and pyramidal cells. The rate of development of axonal processes on neurons is extremely rapid and begins before the neurons have reached their final position, but dendritic growth usually commences after the cell has reached its final

Due to copyright laws Figure 3  
was withdrawn from the manuscript.

position and proceeds at a very slow rate. This discrepancy in the growth of the axons and dendrites is thought to be important since the axons can reach their target cells before the dendritic processes have elaborated, suggesting that the axon may play a role in subsequent dendritic differentiation (Kolb & Fantie, 1989). Pyramidal neurons are found in Layer II through VI with the majority being located in Layers III and V. The cells in the different layers are distinctive morphologically and functionally from one another. Layer V neurons have more apical shafts and spread their apical and basilar shafts over a larger territory than layer III pyramidal neurons. The pyramidal neurons in each layer have different subcortical targets with the large Layer V neurons projecting primarily to the spinal cord, red nucleus and striatum and the Layer III neurons projecting through the corpus callosum and into the opposite hemisphere (Fig. 4) (Porter & Lemon, 1993). The stellate, or glial cells, are born later than neurons, and continue to proliferate throughout life. Oligodendrocytes, a type of glial cell, surround axons and provide them with insulation and are considered a marker of cortical maturity (Kolb & Fantie, 1989). Glial cells are found throughout the cortex.

The neurogenetic theory is contrasted by the Kennard doctrine that suggests that there is a substantial reorganization of the anatomy and function of specific cortical areas after neonatal cortical lesions. The Kennard doctrine stems from experiments done by Kennard in the 1930's on infant monkeys. She thought that the less severe impairments displayed by infant monkeys versus adult monkeys occurred because the cortex in infant monkeys was able to reorganize. Such reorganization has been demonstrated

Due to copyright laws Figure 4  
was withdrawn from the manuscript.

in the rat (Kolb, 1995) suggesting that the functions of cells is not as fixed as is suggested by the neurogenetic hypothesis. The problem with the Kennard principle is that it assumes that all developing brains are equivalent, and it ignores that during the formation of the brain there must be some type of foundation on which to build (Kolb, 1995). If the brain was damaged before having a chance to form the foundation it will not be built correctly.

The neurogenetic hypothesis states that the cells know where they are going to go before they are born. If this process of cell migration is disrupted the brain will be unable to make the foundation on which the rest of the brain is formed. The neurogenetic hypothesis also suggests that there may be constraints on neural remodelling and behavioural recovery following neonatal lesions (Bayer & Altman, 1987). The Kennard doctrine may be true for certain critical times during development, but seems to be the exception rather than the rule.

#### **Development of Behaviour**

To study the relative involvement of the cortex in the execution of certain movements, it is reasonable to begin by using careful, systematic studies of the behaviour and then to relate the behavioural changes to morphological development. One of the first problems that must be addressed in the study of motor development is, how does the neonatal or juvenile animal survive before certain motor behaviours, such as chewing or postural adjustment, have reached a mature functional state? Other questions that can be addressed are: how do the animals change their

behavioural or movement patterns through development? and what neurological changes are occurring to mediate these changes? There is now an extensive literature on the development of motor behaviour in the rat and the possible neurological systems that may mediate these behaviours.

Hall (1979) studied the different aspects of the development of the control over feeding behaviour in rats. In one of his papers, Hall describes the ingestive and behavioural responses to oral infusions of milk. Suckling behaviour is uniquely different from adult consummatory behaviours (Hall & Rosenblatt, 1977). Using oral cannulas located in the front of their mouths, it is demonstrated that pups from P1 through P20 will actively ingest a diet of milk and their intake is related to the length of food deprivation. Pups are capable of an active form of ingestion independent of normal suckling, and it is controlled by physiological factors such as hunger. Hall also demonstrates that food has arousing properties in young animals, but as pups grow older their ingestive response is refined to a specific and directed feeding response.

A classical behavioural development paper is Bolles and Woods (1964) report on the ontogeny of behaviour in the albino rat. In this study, rats are recorded daily for the development of a variety of motor skills. The ability of the rat to right itself from back to front does not show adult competency until approximately postnatal day 10 (P10). Keeping a stable posture demands that there be muscle coordination and an even distribution of body weight. Rat pups are unable to master this ability until P11. By P14 the rats are showing an aptitude for manipulating objects in their environment and exploration through their environment. They are unable to stand upright and balance on



two legs until P18, but to keep their balance on their hindlegs for longer periods of time during exploration they can not maintain their posture until P23.

Bolles and Woods (1964) also demonstrate that the reflexive behaviours are stereotypic organizations of muscle movements that can be seen in most activities. Neonates demonstrate spastic uncoordinated twitch-like reflexes that are gone by P19. Behaviours such as climbing and grooming require skilled coordination between limbs and paws, therefore were not seen until P20/21. Digging behaviour, which is not seen until P24, also requires skilled motor movements and postural support. While the rat is moving forward only the hindlimbs are supporting the animal while the forepaws are digging through the bedding material. Play fighting, which requires the capability of interacting and coordinating movements with a conspecific peaks around P20 to P30. This observational research demonstrates the developmental sequence of different types of behaviours in the rat and shows that certain motor skills, such as postural adjustment, must be in place before subsequent more complex actions like digging behaviour can be performed.

Gard and colleagues (1967) demonstrate a relationship between sensory stimulation and gross motor behaviour during postnatal development in the rat. Rats are either exposed to water or ammonia and their gross motor responses are recorded. During the first week after birth the behaviour of the water-exposed rats is dominated by head movements and by simultaneous movements of the head and forelegs. The rats exposed to ammonia show only a few head movements, but pivoting away from the source is a common

response. During the second week pivoting rapidly increases and becomes the dominant behaviour. Creeping responses in the water-exposed animals is a rare event until P9, but becomes dominant in the ammonia-exposed animals by P2. This study shows that with weak or moderate stimulation, behaviour patterns that do not normally emerge until a later stage in ontogeny may be induced at a much earlier stage. In the present thesis, different motor behaviours are being expressed throughout development that may be related to development of the motor cortex, but if certain behaviours can be expressed at an earlier developmental age it may have implications on the neurological mediation of that behaviour.

Altman and Sudarshan (1975) describe the postnatal development of locomotion in the rat. Their description is largely concerned with how movements are integrated. They demonstrate that between P1 and P21, the emergence of postural and locomotor skills occurs. Righting behaviour is initially accomplished by curving and rocking of the trunk, and later the head and shoulders are rotated. Finally, the hindlimbs are able to turn and provide coordinated support in order for the rat to right itself. Pivoting behaviour dominates the second half of the first postnatal week, crawling behaviour during the second week and walking or running by the end of the second week. The ability to balance on narrow paths and compensating for lateral displacement on rotating rods, which require substantial hindlimb coordination, are not adult-like until around P21. This study demonstrates how complex behaviours during development change which suggests that different brain structures may be mediating the behaviour at different stages

through ontogeny.

Contact righting behaviour is the ability to turn from a supine to a prone position on the ground. In 1991, Pellis, Pellis and Teitelbaum describe the development of this behaviour in a rat from birth until weaning. The ability to right involves both the vestibular and tactile system. At birth the pups are able to complete trigeminal righting when the snout made contact with the ground. This type of righting behaviour shows the adult form of cephalocaudal axial rotation where the limbs flex to accommodate placement on the ground while the body is rotated to prone. Vestibularly triggered righting from the supine position, however, only activates head and neck rotation failed to recruit the shoulders and pelvis to rotate to prone. In the adult form, which is achieved by P12, the shoulder is able to lead the rotation which passively carried the head and neck to a prone position and then recruits the pelvis to rotate to the prone position. A different righting paradigm using asymmetrical contact of the body surface with the ground triggers both forequarter-led and hindquarter led forms of righting. At birth no rotation of the axial musculature is seen, but in the adult form axial rotation by the shoulders and pelvis occurs.

In a subsequent paper, Pellis and Pellis (1994) study the development of a different type of righting behaviour. When a rat is in a bipedal posture and falls, a different system is invoked, resembling the reactions found in air-righting rather than contact righting. The rats are not able to attempt this type of rotation until P7 and then are still not able to demonstrate the mature form until approximately P16. In order to complete this behaviour they must

be able to use their vestibular system as well as their proprioceptive system. This work suggests that righting can be dissociated between static and dynamic whether the same sensory modalities are involved or not. The changes in the different righting behaviours through development demonstrate that there is a complex interaction of righting systems and that this may reflect a pattern of neuronal maturation of the relevant neuronal systems mediating each of the different forms of righting or possibly the maturation of a set of muscles developing independently of the motor systems accessibility to them.

Colani and Fentress (1985) described the ontogeny of face grooming in mice. In this formalized study, the movements of the limb and body segments, the resultant paths which are traced by the forepaws as well as the paths of contact which are traced on the face are analyzed. During the first couple postnatal days the animals groom their faces by using temporally sporadic strokes or bouts of strokes which varied in amplitude and symmetry. Later, the bouts vanish, asymmetry is discarded, and the amplitude of strokes is gradually restricted; the neonates engage in stereotyped, double-symmetrical and asymmetrical strokes. These shifts are accompanied by unidirectional changes such as progressive participation of the trunk, the neck and the head in grooming, which lead to the flexible organization of face grooming characteristic of adults. The findings of this research demonstrate that priorities in behaviours change through development, and behaviours that are seen early in development may disappear only to return at a later chronological date. Golani and Fentress show that all the aspects of adult face

grooming show functional unity and are difficult to distinguish, but during development the individual components lack tight coupling, and therefore can be easily identified.

Bâ and Seri (1995) attempt to map out the developmental sequence of psychomotor and sensory functions in rats. They discovered that reactions to new experiences matured into an adult-like pattern within three postnatal weeks. Exploratory behaviour was low until P10, then peaks from P20 - 30 and then decreases to adult levels by P45. No habituation responses or emotional reactions to novel situations are noted until P20. The rats show mature reflexive and automatic motor function by the third postnatal week and voluntary reactions by P30. Coordinated complex movements and motor initiative is not adult-like until P20 and the latency of crawling on a wire and jumping down decreases after P20 until it hits adult times by P45. Bâ and Seri demonstrate that the CNS develops in a caudal to rostral sequence and that there may be a time dependent gradient of functional maturation of the nuclei. This suggests that there may also be a maturation gradient of motor behaviours that follows parallel, or subsequent, to CNS development.

Studying the development of behaviour can also lead to insights into learned or experience dependent behaviour. There are neurological constraints on a developing animal's ability to acquire specific behaviours when compared to an adult animal. Certain sensory systems may not be developed until later in ontogeny and even when these systems are functional they may not be used for acquiring specific behaviour. One example of this is found in a study by Hyson and Rudy (1984) in which

neonatal rats are able to respond reflexively to sounds several days before those sounds can be used as conditioned stimuli for the delivery of oral infusions of sucrose through a cannula. Moye and Rudy (1985) also show that rats display unlearned reflexive behaviours to a flashing light stimulus several days before that stimulus could be used for associative learning in an aversive shock paradigm. The ability to control sensory reflex behaviours is also seen in the gustatory system, where pups display reflexive responses to taste stimuli before they are able to acquire a learned aversion to that stimulus (Vogt & Rudy, 1984). These experiments suggest that each sensory system independently goes through a similar developmental progression and the system's capacity to mediate reflexive behaviours appears before it can mediate learned behavioural reactions.

In a more complex learning paradigm the dissociation between the ability to use visible (ie. proximal) cues, and the relationship between cues more distally located in a Morris water maze learning task is seen in ontogeny as well (Rudy, Stadler-Morris & Albert, 1987). Rats at P17 are able to use proximal cues to locate a safe platform, but they are not able to utilize distal cues to locate a hidden platform until P20. This is evidence that the neurological system for integrating distal information is separate from the system needed to solve proximal cue tasks and that the system for distal information may be processed at a neurologically higher level.

### **Conclusion**

The idea that the brain has areas that are functionally distinct is not in

dispute, but what behaviours areas mediate is still under investigation. Developmental psychobiology studies, such as those conducted by Hall (1979), Golani & Fentress (1985), and Pellis & Pellis (1994), have advanced our knowledge of brain structure and function relationships and have given us a guideline with which to base further studies into the understanding of the neurological basis of behaviour. To determine what the functional significance of each area, it is necessary to analyze how the areas of the brain are connected and how they communicate with one another. To get a good understanding of what components of behaviour are produced by each of these areas or system of areas, the ontogeny of the behavioural and morphological sequences of events needs to be investigated.

### Research Approach

During the development of mammals, the brain is in a constant state of change, reflecting the transformation of the brain from an immature to an adult state. The research conducted in this thesis examines the relationship between complex motor behaviours related to eating and some anatomical events that take place within the forelimb area of the motor cortex.

Whereas studies of feeding have generally looked at how animals have reached mature states, such as the transformation from suckling behaviour to eating hard food (Hall, Cramer & Blass, 1977), no attention has been directed towards complex behaviours that animals use in finding, protecting and handling food. Rats must be able to find food and to do this they must be able to use some type of sensory system, such as vision, to help them navigate to food patches. Once they locate food, they have to be able to handle it, which requires skilled forelimb movements and coordination. Rats are able to use skilled movements in order to reach, manipulate, and eat the food. They must be able to keep and protect the food from conspecifics.

A large body of literature has been devoted to describing the rats' ability to reach for food (Peterson, 1934; Whishaw & Tomie, 1989A; Whishaw & Pellis, 1990; Whishaw, Pellis & Gorny, 1992; Whishaw & Gorny, 1994; Ivanco, Pellis & Whishaw, 1996). Reaching ability requires the animal to be able to lift one forelimb off the ground, while standing, and bring the elbow into the midline of the body so that the paws are adjacent to the mouth. The reaching component consists of a series of acts including pronation of the forelimb during the reach, so that the palm of the paw is facing down, and the digits



form an aperture that is approximately the size of the food object. The paw then grasps the food and supinates so that the palm is facing into the midline of the body while the forelimb is being retracted towards the body. Once the paw is in close proximity to the body the forelimb again supinates so that the food is in contact with the mouth. Lesion experiments have shown that this reaching sequence is severely impaired following motor cortex lesions (Greenough, Larson & Withers, 1985; Whishaw, O'Connor & Dunnett, 1986; Whishaw & Kolb, 1988; Whishaw, Dringenberg & Pellis, 1992; Whishaw, Pellis, Gorny & Pellis, 1991; and Castro-Alamancos & Borrell, 1993).

Digit manipulation is another aspect of food handling. It was once believed that rats were unable to use their digits in any skilled fashion and that this behaviour was only displayed by primates (Lawrence & Kuypers, 1968). Whishaw and Gorny (1994) demonstrate that rats are able to use their digits individually and that they display an arpeggio pattern movement when grasping a food pellet. This movement consists of the digits being placed, in succession, on the surface in front of the food pellet starting with digit 5. Digit 5 is also able to be used in a precision grip. When rats are eating pieces of angel hair pasta they are able to use digits 1 and 2 in a precision grip (Whishaw & Coles, 1996).

Rats are able to eat a variety of foods of many different shapes which require different paw holding and manipulating patterns. They are able to use their paws either symmetrically, so that both paws are using the same types of actions, or asymmetrically which requires bimanual coordination of the forelimbs and paws (Whishaw & Coles, 1996). Angel hair pasta eating

requires that the rat use each forelimb for different jobs. While eating pasta the lower paw on the food is placed with the pasta being firmly grasped in a power grip; where the object is clasped against the palm of the paw and the digits are closed around it, and the upper paw is placed near the mouth with only the tips of the digits grasping the pasta in a precision grip. The lower paw is used to feed the pasta up into the mouth and the precision grip is used to guide the pasta into the mouth. The ability to carry-out this behaviour is also severely impaired in rats with unilateral motor cortex lesions, giving further evidence for the hypothesis that the motor cortex is involved in forelimb movements (Whishaw & Coles, 1996).

Once the animal has the food in its possession it is faced with the problem of whether to eat the food where it was found, or to take the food to a different location that may be safer. Whishaw and colleagues have shown that the rat is able to estimate how long a piece of food will take to eat and compare that result with the length of time it would take to travel to a safe location (Whishaw & Tomie, 1989B; Whishaw, Nicholson & Oddie, 1989; Whishaw, 1990; Whishaw & Dringenberg, 1991 and Whishaw, Gorny & Dringenberg, 1991). Rats are able to assess different variables such as predator proximity, distances to safe areas, as well as the length of time required to eat a piece of food. When the rat is going to carry the food it puts the food in its mouth and runs on all four limbs.

Another threat that rats are faced with while eating is from conspecifics trying to steal the food away. Many studies of the reactions of the feeding animal to robbery attempts from conspecifics have been carried out

(Whishaw, 1988; Whishaw & Gorny, 1994; Whishaw & Tomie, 1987, Whishaw & Tomie, 1988; Field, Whishaw & Pellis, 1996). To study this defensive behaviour, two rats are food-deprived and placed in an enclosure with one piece of food large enough to cause the feeding rat to dodge away from the robber. It has been shown that rats will dodge away from a robbing animal different distances depending on the length of time it takes the rat to eat the piece of food, resulting up to 180° from the conspecific. There exists a sex difference in how rats will dodge away evident in paw placing patterns and movement through space. Female rats move their snout through a larger spatial arc, and their snout achieves a greater velocity, comparatively to the pelvis, than males. Males make more hindpaw steps than females and attain a more concurrent movement of the fore- and hindquarters. This suggests that females pivot around a point more posterior on the body than males (Field, Whishaw & Pellis, 1996). Whishaw & Tomie (1988) have shown that the cortex has some involvement in the ability of the rat to steal or dodge away from conspecifics, which may possibly be mediated partially by the forelimb area of the cortex since the forelimbs are being used to manipulate and hold the food while the rat dodges away from the robber. Furthermore, the robber has been noted to reach in with a paw to attempt to dislodge the food from the feeding rat.

Since reaching, bimanual coordination, food-carrying and dodging and robbing behaviours are skilled movements requiring motor cortex, the logical place in the brain to investigate forelimb control is the forelimb area of the motor cortex (Whishaw & Gorny, 1994; Whishaw & Coles, 1996). That motor

cortex has been implicated in each of these behaviours through lesion studies, confirms this conclusion. Experiment 1 of this thesis is designed to establish when complex movements, including reaching, bimanual coordination, food carrying, and dodging & robbing appear.

The developmental approach also suggests that as behaviour develops its maturation will reflect the maturation of the cortex (Kolb & Whishaw, 1995). In experiment 2, the forelimb area was selected for anatomical analysis. To investigate cortical maturation, measures were made of: cortical thickness, neuron morphology, astrocytes, myelination, neurotransmitter activity, and immediate early gene activity.

Cortical thickness is a measure of volumetric growth of the cerebral cortex. To quantify this change through development the Nissl bodies found within the cell body were stained using cresyl-violet, and the thickness of the FL area was measured at each age. It has been shown that with the first three weeks of age, the rat's cortex dramatically increases to almost adult thickness and then gradually increases to mature levels by day 60 (Van Eden & Uylings, 1985). It has also been shown that the hemispheres have an asymmetric growth in development that persists into adulthood (Diamond, 1987; and Van Eden, Uylings & Van Pelt, 1984).

The development of Layer III pyramidal neurons was assayed using the Golgi-Cox silver impregnation method. It stains a small percentage of the total cells within the cortex and stains all of their processes. The cells are drawn using a camera lucida method and quantified using Sholl and Branch Order Analysis. Petit and colleagues (1988) characterized the postnatal growth

of the pyramidal neurons found in layer V of the rat motor cortex and show that they are morphologically mature by P20, but do increase their dendritic branches into adulthood.

Astrocytes and neurons communicate with one another and mutually influence one another (Rakic, et al, 1994). Astrocytes are also involved in the differentiation of neurons and growing axons (Barres & Raff, 1993, Georgiou, et al, 1994; Murphy, et al, 1993; and Shao & McCarthy, 1994). Astrocytes were measured indirectly using an antibody to glial fibrillary acidic protein and the processes were counted using a stereological method.

Myelin facilitates the conduction of electrical signals between nerve cells (Kandel, Schwartz & Jessell, 1991). Fritsch was the first to use myelination as a marker of cortical maturity during development in animals (Young, 1970). Myelination of axonal processes is measured by using Schmued's Gold Chloride Stain and measured using densitometry.

Development of the acetylcholinesterase system in the developing cortex has been established (Krnjevic & Silver, 1966; Krnjevic, 1988) as well as a more detailed analysis in the visual cortex (Robertson, 1988). It has been implicated in plasticity and the development of synaptic connectivity (Sillito, 1993). Acetylcholinesterase (AChE) was used as the measure of acetylcholine activity and extent of development of the ACh projection into the FL Area of the cortex.

During development and for plasticity, the cortex depends upon activity to modulate gene expression. One immediate early gene that has been used as a marker of these activity patterns is c-fos. This gene has been

implicated in cellular growth and differentiation in the brain (Sheng & Greenberg, 1990; and Alcantara & Greenough, 1993) and has been shown to be activated by many different external stimuli, such as vibrissae stimulation (Miura, 1994). General activity of the FL area was measured using the immediate early gene *c-fos* using an immunohistochemical assay and counting the number of stained nuclei found in FL area.

Using the information on the emergence and maturation of specific behavioural events and combining it with the development of the forelimb cortex, this thesis attempts to discover whether there is a chronological relationship between development of brain structure and function.

## Chapter 2: Behavioural Development

Rats provide ideal subjects for developmental studies as they are motorically mature within 60 days of birth. Within this time period their various patterns of behaviour emerge sequentially and rapidly. As noted in the Introduction, there have been many developmental studies that examine the emergence of such behaviours as feeding, drinking, postural righting, locomotion, and grooming. Throughout this period of development the nervous system of the rat is undergoing an equally rapid process of development. Surprisingly, there have been few attempts to correlate behaviour with the details of anatomical change. This is in part because the precise structures subserving each behaviour as are yet unknown and in part because there are so many concurrent changes occurring in both behaviour and the brain that correlations are difficult to interpret. The purpose of the present thesis was to approach these developmental process in a different way. A series of feeding-related behaviours that appear to depend upon cortical function have been identified in adult rats. The object here, therefore, was to examine the maturation of these behaviours and correlate their maturation with at least one brain structure known to be involved in their execution.

The purpose of Experiment 1 was to determine the time and the duration of maturation of a number of feeding related behaviours. Behaviours of interest were: robbing and dodging, food handling, food carrying, and reaching with a single limb to obtain food. In addition, a number of other behaviours including eye opening, eating hard food, and the

development of postural support, which have all been recorded in previous work (see Introduction), were sampled in order to provide reference points for comparison with other work. The strategy used in the experiments was to film litters of pups in the morning and in the evening, times at which rats in the colony are normally most active. The videotapes were then examined and the behaviours displayed by the pups was recorded. As some behaviours were quite complex and also depended upon the maturation of movement ability more generally, their further analysis was achieved by more detailed examination of the videorecordings. In the results section a chronology of behavioural development is provided, and from this chronology, details of the maturation of specific behaviours is extracted.

## METHODS

### *Subjects*

Three litters of Long-Evans Hooded rats (University of Lethbridge Breeding Colony) were used over the course of the experiment. One litter consisted of seven male and five female pups and the dam. The other two litters consisted of three males, three females and the dam (one of the female pups died during filming, therefore one litter only had two females). The day of birth is considered postnatal day 1 (P1) for the purposes of this study. The litters were transferred from the breeding colony to the testing apparatus when the pups reached postnatal day (P) 10, where they lived until P30. Weaning occurred at P21 when the dam was removed from the testing apparatus. They were kept on a 12:12 hour dark/light cycle with the light



cycle starting at the 08:00 hour.

#### *Apparatus*

The apparatus was made of clear Plexiglas (Fig. 5). The nest area was a rectangular shaped box (40.7 cm wide, 30.7 cm high and 28.5 cm deep) with an opaque Plexiglas shelf (16.0 cm X 28.5 cm) attached to the walls (16.0 cm off the floor) which opened into a clear Plexiglas alleyway (38.0 cm long, 15.4 cm high and 15.4 cm deep) connecting the nest area to a removable rectangular feeding area (38.0 cm long by 38.0 cm high by 38.0 cm deep) (Fig. 5A). The feeding area has an optional reaching insert which has six slots, with each slot being 1.2 cm wide and a metal tray (37.0 cm long by 3.7 cm wide by 0.5 cm deep) 1.8 cm off the floor (Fig. 5B). At P20 the feeding box was exchanged for a box (28.0 cm wide by 28.0 cm high by 29.0 cm deep) with a single slot precision reaching shelf attached to the front wall (Fig. 5C). The top of the nest area and the feeding area were hinged to allow access. The floor was covered with bed-o-cob bedding material (The Andersons, Industrial Products Division, Maumee, Ohio) and was changed every three days.

#### *Food*

The rats were fed standard rat chow ad libitum as well as angel hair pasta (Capelli d'angelo, Catelli, Montreal, Quebec, H1N 2E5), chicken feed (New Life Feed, Calgary, AB), sunflower seeds, and banana flavoured precision pellets (20 mg) (BioServe, P.O.B. 450, Frenchtown, NJ).

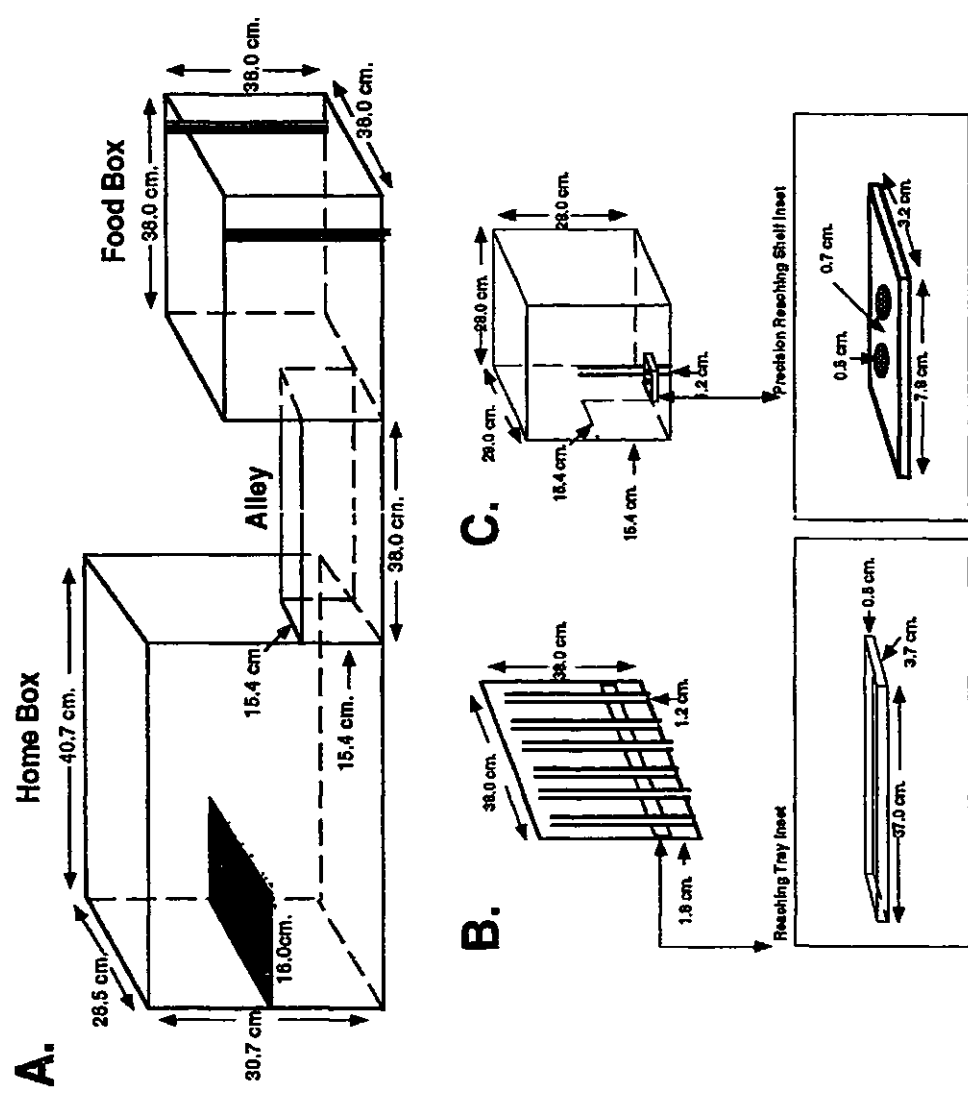

Figure 5. Home cage for developing rats. A. Home cage. B. Reaching tray attachment. C. Reaching slot attachment.

### *Filming*

Observation and videotaping sessions averaged 30 minutes to one hour each, and took place at 8:00 and 17:00 hours from P15 until P30. The behaviour of the rats was filmed with a Sony Hi-8 portable camera and the tapes were replayed on a Sony Hi-8 deck for frame by frame analysis. The apparatus with the reaching tray (Fig. 5A) was used from P15 until P25, at which time the precision reaching option (Fig. 5B) was attached. The first litter was filmed for observational purposes in order to establish a basic timeline of when specific behaviours were established. The other two litters were sexed and their pelage patterns were recorded for individual identification purposes.

## RESULTS

The results section consists of three parts: I. a description of the adult movement patterns that are relevant to the behavioural analysis, II. a descriptive overview of the development of behaviour in the rat pups, and III. a statistical summary of the development of behaviour.

### **I. Description of Adult Movement Patterns**

The mature form of each of the behaviours of interest will be described in detail before the description of the behaviours as they emerge during development. The behaviours of interest include: (1) Robbing, (2) Dodging, (3) Carrying behaviour, (4) Reaching, and (5) Bimanual Coordination.

**(1) Robbing**

Robbing behaviour is characterized by a rat walking up alongside the other rat's body from the rear, with or without touching the victim's body, and attempting to grasp the food either with the mouth or with a reach of one of the forelimbs in conjunction with the mouth (Fig 6A) to seize the food. Dodging behaviour, by the victim, generally leaves the would be robber behind, and because most robbery attempts are executed in series, a rear approach is the most direct route to the food. The robber also may appear less conspicuous in using this approach. The robber often presses against the body of the victim on its approach, which may suggest to the victim that it is attempting to huddle rather than seize food (Whishaw & Tomie, 1988).

**(2) Dodging**

Dodging is a defensive tactic in which the feeding rat uses forequarter rotation and hindlimb stepping movements in order to escape from a conspecific attempting to steal food. A dodge is initiated by a contraversive rotation of the front half of the body, followed by a contraversive step of the ipsilateral (to the turn direction) rear leg, and completed by a following step with the other rear leg (Fig. 6B). Sometimes a rat may further distance itself from the robber with a short run or a rabbit-like hop (Whishaw & Gorny, 1994). Dodging behaviour requires the turning of the fore part of the body as

Due to copyright laws Figure 6  
was withdrawn from the manuscript.

well as stepping with the rear limbs (Whishaw & Tomie, 1987).

### **(3) Carrying Behaviour**

Hoarding is the transportation of objects, particularly food, from a source to a secluded area (Ross, Smith, & Woesnner, 1955). Laboratory rats have been observed to hoard, and extensive literature has been directed towards identifying the factors that influence its occurrence. Rats have been known to hoard food, water (soaked cotton), nesting material, and miscellaneous items. Hoarding behaviour can be subdivided into two categories: carry-to-eat and carry-to-leave. In the carry-to-eat paradigm (Fig. 7) the rats carry a piece of food to a different, generally more secluded, area in which they immediately begin to eat the food item. In the carry-to-leave paradigm the rat carries a piece of food, or other item, to a different area and then leaves it and comes back to it at a later time. The latter behaviour is apparently a form of scatter hoarding in which rats will distribute food items around the home territory (Whishaw & Tomie, 1989B). Rats will typically only carry food that will take longer to eat than to transport back to a safe place (Whishaw, Nicholson, & Oddie, 1989; Whishaw & Tomie, 1989B; Whishaw, 1990; Whishaw, Oddie, McNamara, Harris & Perry, 1990; Whishaw & Dringenberg, 1991).

### **(4) Reaching**

A reach consists of lifting the forelimbs from the ground, positioning the elbows in, so that the paws are adjacent to the mouth, and clasping the

Due to copyright laws Figure 7  
was withdrawn from the manuscript.

food with the digits. These movements are executed mainly with the upper forelimb. As the limb is positioned for grasping, the aperture of the digits is adjusted to anticipate the size of the food and the food is grasped and manipulated with the tips of the digits. The food is then supinated approximately 90° as the paw is retracted back in towards the body, and then supinated 90° once again in order for the rat to retrieve the food with its mouth from the paw. A cartoon example of a reach is demonstrated in figure 8 (Whishaw & Tomie, 1989A).

#### **(5) Bimanual Coordination**

Bimanual coordination is the ability of an organism to use both forelimbs carrying out two different behaviours in order to solve a task such as pasta eating (Fig. 9). To eat a piece of angel hair pasta the rat must first pick up the pasta with its mouth and then sit back on its haunches and grasp the pasta with the paws. Rats have a preferred holding and orientation style and will flip the pasta into position if it is in the wrong position to begin with. The food is manipulated with the paws so that one paw supports the pasta and holds it near the mouth and the other paw, held lower on the pasta, advances the pasta to the mouth for chewing. The typical paw posture as the pasta is eaten has the holding paw located beside the mouth and the manipulating paw located toward the distal end of the pasta (Whishaw & Coles, 1996).

The typical eating posture is characterized by a rat sitting back on its haunches using the hindfeet as the base of support for the body in a slightly



Due to copyright laws Figure 8  
was withdrawn from the manuscript.

## Bimanual Coordination

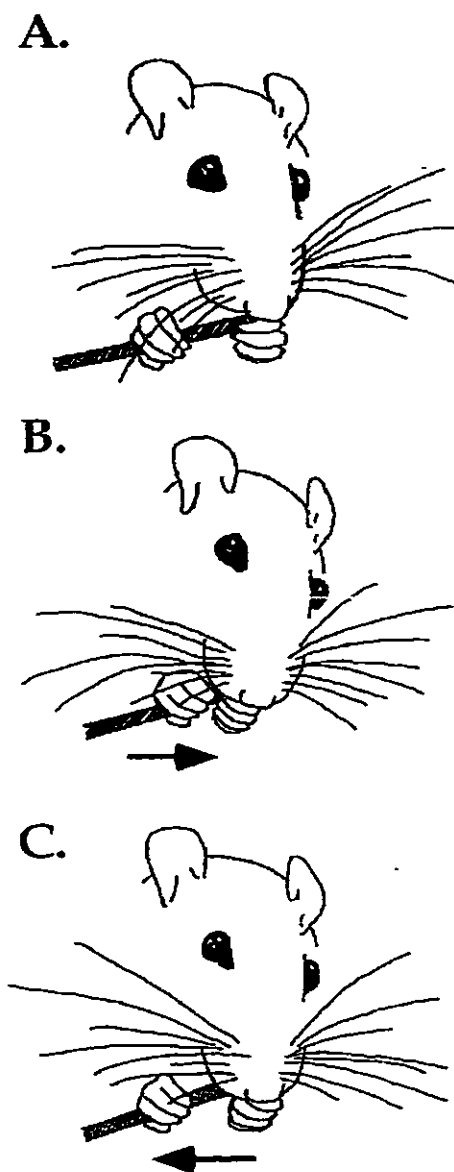

**Figure 9.** Bimanual Coordination using a pasta eating task.  
A. Lower paw is in a power grip and the upper paw is in a precision grip. B. The lower paw feeds the pasta into the mouth. C. Once the paw is in a symmetrical grip it lets go of the pasta and replaces it lower down on the piece of pasta.

splayed manner. The forelimbs are held underneath the snout and are used to hold and manipulate food. The body is kept in a stable upright position, slightly forward of the hindlegs, so that the food is not touching the ground, and the body is held in that position throughout the eating bout (Fig. 10).

## II. Chronology of Behavioural Development

The patterns of movement related to feeding behaviours are described in the style of Bolles & Woods (1964). Therefore, the procedures used in this section of the experiment are purely observational and are used to determine, qualitatively, the characteristics of the behavioural patterns in rat pups as they emerge chronologically.

**P15:** At this age, less than half of the rat pups have their eyes open. All pups demonstrate locomotory and exploratory behaviours in their environment. Sniffing of the rat chow is a common behaviour with a few pups licking at the food and attempting to bite pieces off. Pups, with eyes open, are attempting to bite pieces off the rat chow that the dam has brought down to the nesting area.

**P16:** All of the pups eyes have completely opened. The pups are attempting to chew on the hard rat chow. While attempting to eat the rat chow, the pups are unable to maintain an upright posture, therefore in order to eat successfully the pups lay down on the ground with their front legs on either side of the rat chow pellet and with their paws splayed out on the sides and on top of the food to hold it in place. The pups then use a

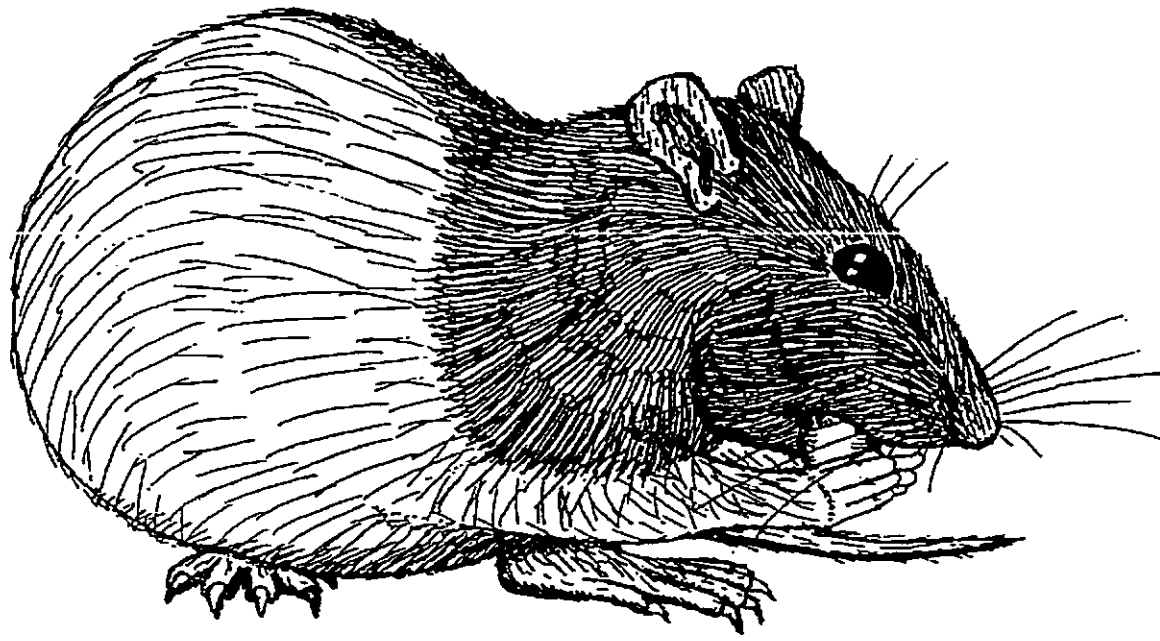
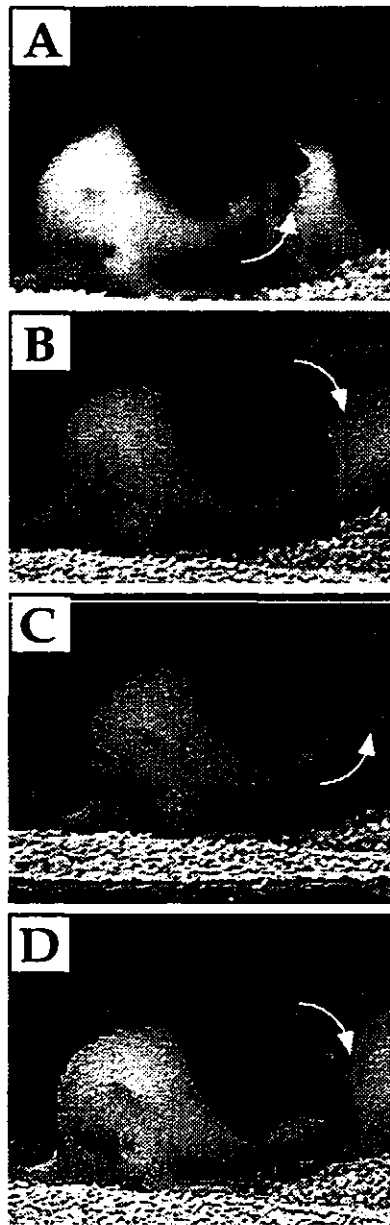

Figure 10. Eating posture. When a rat is eating, it sits back on its haunches so that the hindlimbs are the sole support, leaving the forelimbs free to manipulate the food object.

upwards levering motion, with the bottom teeth being used to break off pieces of the chow into their mouths. They are able to use their paws in a symmetrical pattern to rotate the food, possibly in order to get the food in a better location to break pieces off. Attempts to chew on the angel hair pasta occur, but the pups seem unable to break the pasta with their teeth and therefore spend less time with it than with the rat chow. The pups seem to be very easily distracted and will change from one behaviour pattern to a new one very quickly.

**P17:** The pups are still unable to sit up on their haunches in order to eat the food pellets. Some pups are attempting to pick up the rat chow and sit up, but when they are able to get back on their haunches with the food they sink slowly down towards the ground and make compensatory motions by jerking back up with the food, causing the pup to make see-saw type motions while it is attempting to eat (Fig. 11). During grooming the pups topple over if they are not leaning up against a wall or a sibling for support. The majority of the pups still lie down on the ground with the food pellets and lever off pieces of food with their teeth. The pups are attempting to pick up the pasta in its centre. Once they were successful, are unable to get the tip of the pasta into their mouth and drop the pasta on the ground and leave it. A few pups are able to get the tip of the pasta into their mouths but do not seem to be able to break the pasta with their teeth. The observation was made because they would make biting motions on the pasta and would quickly drop it onto the floor, but would attempt the behaviour again in a few minutes.

## Postural Adjustments



**Figure 11.** Postural adjustment made in P17 rat pup. A. The pup sits back on haunches to eat. B. Slowly sinking towards the floor. C. Readjustment back to eating posture. D. Sinks back down to floor.

Robbing was prevalent. In this behaviour one rat would be eating a piece of food and a sibling would try to steal the food. The attempts to steal the food were successful. The dam would dodge away from her pups if they attempted to steal food from her, but the pups never attempted to dodge away from their siblings or the dam. The pups were also carrying the banana pellets from one location to another in order to eat them, i.e. carry-to-eat behaviour.

When sunflower seeds were introduced into the home cage the pups readily tried to manipulate them using an asymmetrical paw holding pattern. The paws held the shell on either end and chewed the top of the shell off and peeled it away from the seed until they were only holding the seed. They were unable to get the seeds out of the shell in a very efficient manner and spent a lot of time manipulating the shells with their paws and mouth.

The pups engaged in tail pulling behaviour using their teeth to grab onto a sibling's tail and pull it backwards. They also chewed on parts of the home cage, such as metal screws. This oral manipulation suggests that the rats are going through a teething stage, not unlike human babies.

P18: The pups are able to sit up on their haunches when eating small food pellets, but are still very close to the ground and their hind legs are splayed outwards in an exaggerated manner giving the pups a wide base of support to keep them more upright while eating. The pups are see-sawing when eating in this position, but are able to make more rotary movements with their paws during manipulation of the pellets. Some pups use the walls or their siblings as a leaning support while eating. When the pups are able to

get this support, they are able to maintain an adult-like posture in order to eat food pellets. Male pups spend much of their time rearing up on the walls, but the females only go up on their hind legs if they are attempting to eat.

The pups are still unable to eat the angel hair pasta, but still spend time manipulating it. They pick up the pasta in the centre and try to grasp onto it with their paws on either side of the mouth, but they generally drop the pasta onto the ground. When the pups are attempting to reorientate the pasta in order to get the tip in the mouth they generally drop it onto the ground. The pups have spastic movements at this age and generally drop the food a lot.

Carry-to-eat behaviour is still prominent, but now the pups are carrying large rat chow pellets short distances. Manipulation of the sunflower seed shells is more coordinated in that they can turn the shell around in their paws without dropping it. The males are starting to dodge away using backward movements and then turn away from the approaching robber, but are not successful at keeping the food from the robber.

Digging behaviour is prevalent. They attempt to dig underneath the reaching slots, but are not actually reaching through the slots for food. They display an elbow to midline behaviour when reaching.

**P19:** The pups are spending more time play fighting and allogrooming than eating. They are still carrying food down to the nest in order to eat it, and are still very low to the ground when attempting to sit up on their haunches. The hind legs are not quite as splayed out as they were on P18. Dodging behaviour is still abnormal compared to that seen in adults, in that they are not turning away from the robber very quickly or a long enough



distance from the robber (Fig. 12) so that they are still losing the food the majority of the time. Their digits appear to be much more controlled and may be moving in an individualistic manner. All the pups attempt to reach for food through the reaching slots, but are not successful. This may be due to the fact that they are unable to aim their body or demonstrate pronation.

**P20:** In the carry-to-eat behaviour the pups only carry food that would take longer to eat than to transport to a different location in the enclosure. While sitting up on their haunches to eat, the pups are able to maintain balance for a longer time in a high stationary position, but do start to see-saw before they are finished eating a banana pellet.

Dodging is not adult-like, but the pups are able to turn to a greater degree and do not lose the food to the robbers all of the time. The robbers, in response, have changed their strategies. The robber, instead of coming straight at the pup head-on, are now attempting to come up alongside and steal the food from underneath the paws with their mouth. The reaching behaviour has not improved from P19, but they are now twisting their bodies in order to get the foreleg through the slots. They are still not able to successfully grasp the chicken feed, but they do not appear to be able to pronate.

**P21:** Many of the pups still use a support, such as a wall or a sibling, in order to sit up on their haunches to eat the food pellets. The male rats are able to sit, unaided, in an adult-like eating posture in order to eat all sizes of food pellets, but the females are still using support to attain the same goal or they demonstrate the see-sawing behaviour. While eating pasta, the majority

## Dodging & Robbing

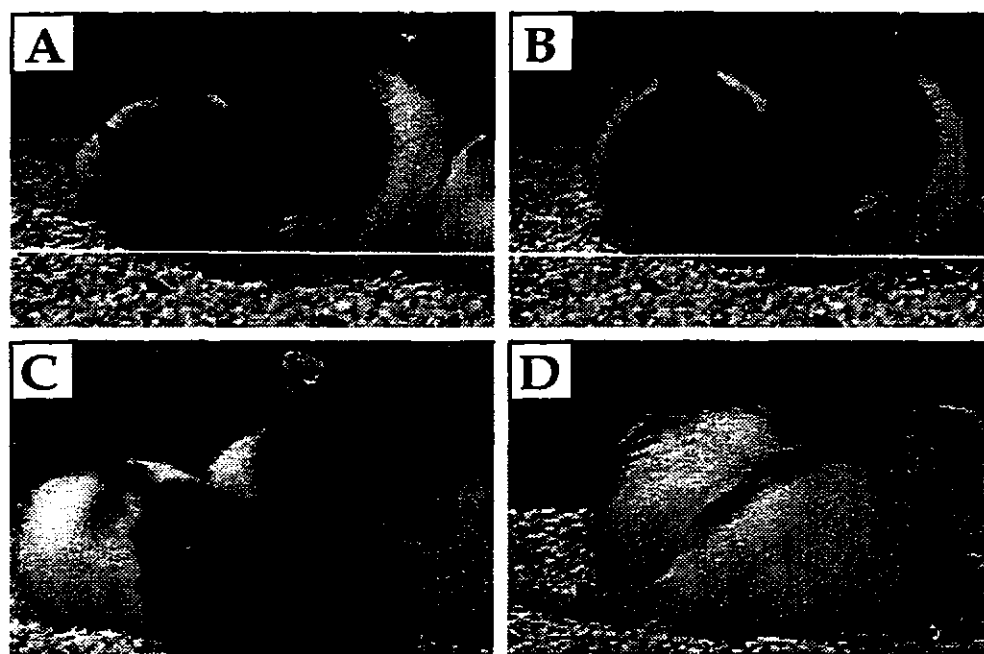

**Figure 12.** Immature Dodging and Robbing. A. The robber approaches from alongside the feeding rat. B. Turns the head in towards the mouth in an attempt to steal the food. C. The feeding rat twists the upper half of the body away from the robber. D. The feeder attempts to dodge away while the robber follows closely.

of pups are able to acquire an asymmetrical paw holding pattern similar to the adults, but not all are able to break the pasta with their teeth. The pups primarily have digit 5 behind the pasta and the rest of the digits wrapped around the top in a power grip. Reaching attempts have become more frequent, but no successful attempts have been made. During the reaching attempt the nose is aimed into the slots, the elbow is brought to midline and then the reach is initiated. The pups then start to twist their bodies and are unable to grasp the chicken feed.

**P22:** The male pups do not display the see-sawing behaviour at all at this age, but the females are all still having problems maintaining posture and are see-sawing. This difference may be due to the varying ways the adult male and female rats sit up on their haunches. The males tend to put the majority of their body weight onto the heel of their hind feet, but the females appear to put the weight more forward onto the pads and digits of the hind feet. The pups are now carrying more than one of the small banana pellets down to the nest area, but still only carry one of the large pellets back, presumably because of size. The pups are using more manipulatory movements with their paws when picking up and eating food pellets. The pellets are being rotated in an adult-like manner.

Dodging has become more adult-like, but they do a lot of backwards dodges over the robber and are not successful in retaining the food. The robbers are becoming more successful at stealing the food. The pups are still attempting to reach through the slots, but still are not successful in grasping the food with their paws.

**P23:** The male pups still have a fairly stable posture while eating pellets, but in a few males the forebody still sinks towards the ground, the females are all unable to maintain a stable upright posture. When there is a large supply of banana pellets at the food end, most of the pups will stay down at that end to eat them with only a couple of pups carrying them down to the nest end (Fig. 13). Dodging is fairly mature, and the rats generally do not lose the food to sibling robbers. The dodging angle is close to  $180^\circ$  away from the robber when eating a piece of rat chow. All the pups are able to get the pasta into the correct eating position, but not all are able to eat the pasta and most give up quickly after they have attempted to bite the pasta.

All of the pups are attempting to reach for chicken feed through the slots (Fig. 14). The pups have various approaches to reaching for the food. Some pups stand parallel to reaching tray and reach in at an angle and can be successful. Pups generally stick their nose through the slot up to the eyes and then shift the body sideways ipsilateral to the paw they are reaching with. The elbow is coming into midline, but the paw does not seem to be pronating like an adult, it is tilted somewhat, and when the paw comes back through the slot it is still in the same orientation, therefore no supination is occurring. The percentage of right and left pawed reachers is about 50 percent. Many pups are trying to use both paws to reach with, but the tendency to one paw or the other seems to be based on first success, i.e. if it is successful with the left it will become left dominant.

**P24:** All of the pups are now eating the food pellets in a stable, adult-like upright posture. There is no see-sawing motion noticeable in any of the

## Carry-to-Eat

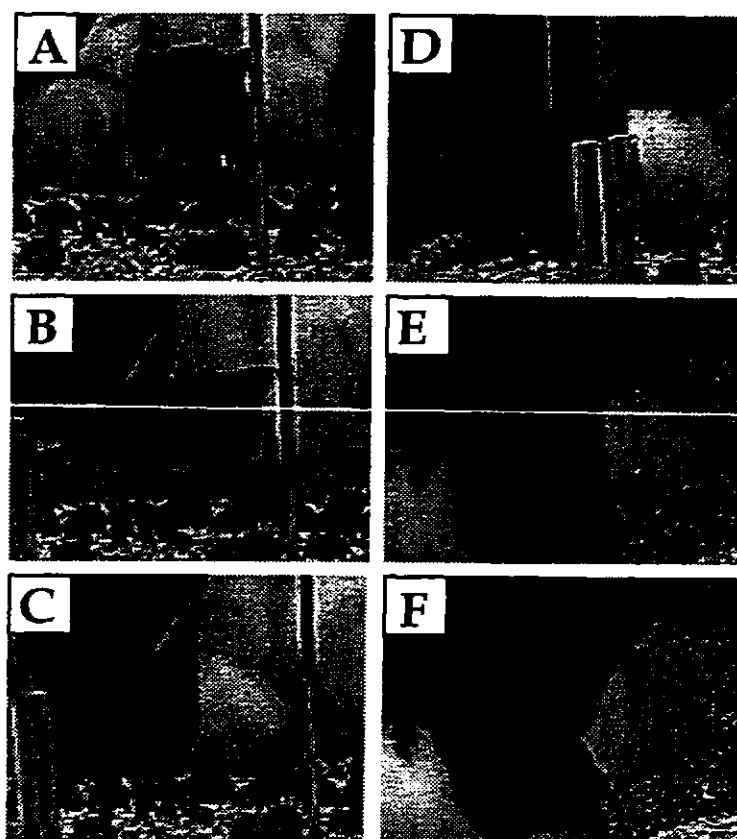

**Figure 13.** Carry-to-Eat behaviour. A. The pup picks up a banana pellet at food end. B. It dodges towards the nest area. C-E. Runs down the alleyway to nest end. F. Eats food pellet at nest end.

## Reaching

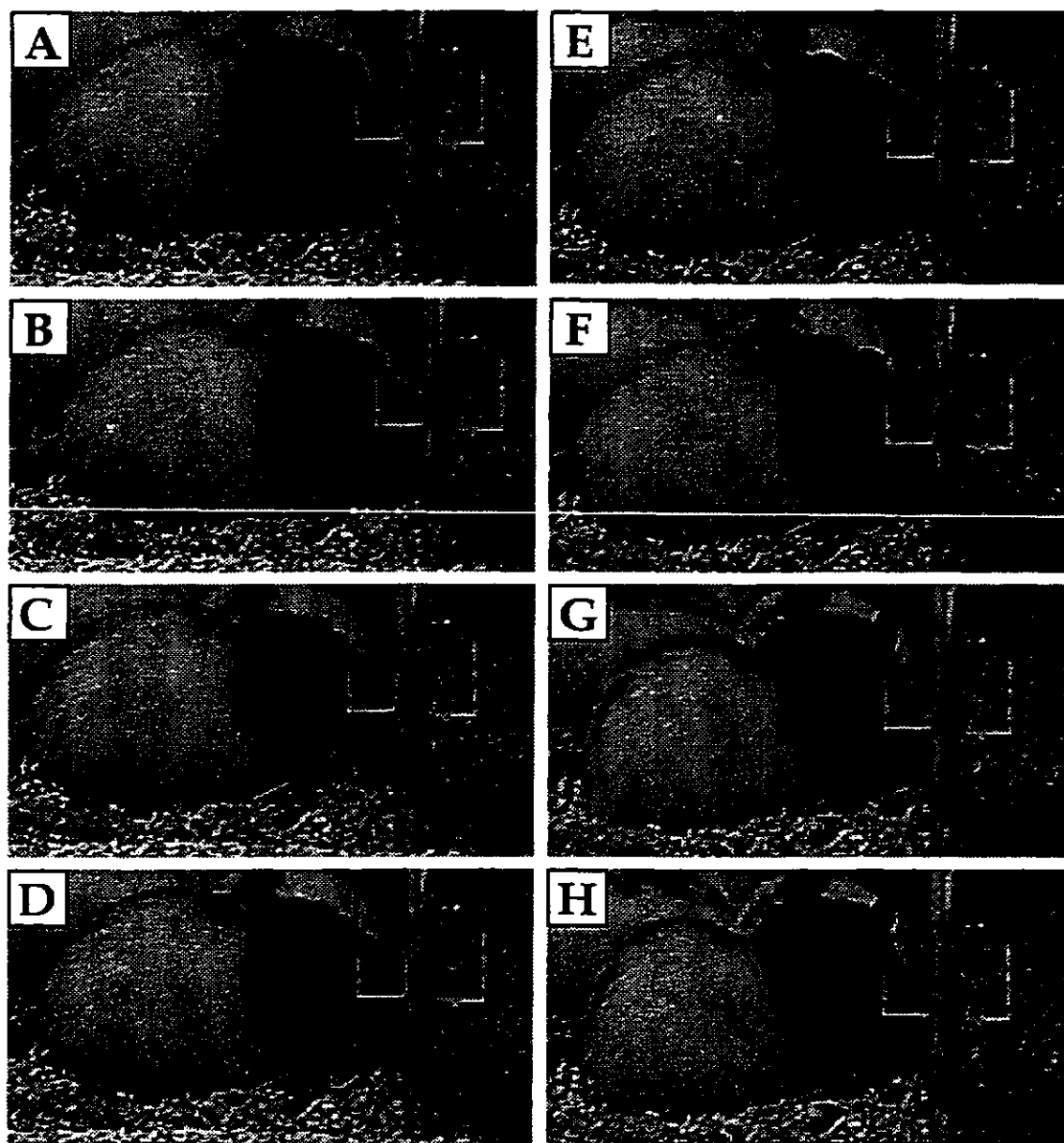

**Figure 14.** Reaching for chicken feed. A. Rat approaches the reaching slots. B. Alignment of the nose perpendicular to tray. C. Forelimb lifts up. D. elbow into midline. E. Reach. F. Grasps chicken feed. G. Retraction of the forelimb back towards the body. H. Supination of forelimb to eat food.

pups, and no pup lays down in order to eat the large pellets. Some pups do appear to be sitting up on their haunches higher than their siblings.

While eating pasta, many of the pups try flipping it from one side to the other and end up eventually dropping it. About half of the pups are demonstrating adult-like asymmetrical paw holding patterns on the pasta, but some are still not able to eat it. During dodging and robbing, the pups are losing the food quite a bit of the time, but are dodging away from the robber most of the time.

Reaching behaviour is becoming more successful. Many pups are more than 50 percent successful in an eating bout. A female pup gets one hit for every miss, and generally seems to be fairly accurate in reaching capabilities. She reaches through the slot only half way up to the eye, and when the paw is through the slot the paw is in typical grasping pattern, i.e. pronated and digits are open, she then grasps the food, retracts the forearm and supinates the paw. She then supinates once again to bring the food into the mouth. Most of the pups seem to be demonstrating this type of pattern. Many pups dodge away from the tray whenever they are successful at grasping food.

**P25:** When pups are dodging away from a robber, they will almost always make 180° turns away and are fairly effective in retaining their food. The pups are carrying the angel hair pasta down to the nest end in order to eat it. The majority of the pups start out holding the pasta in an asymmetrical paw holding pattern, and break off small pieces of pasta into the mouth using the teeth. One paw generally is used in a dominant manner, i. e. pushing the

pasta up into the mouth. The pups do drop the pasta most of the time, and are unable to eat a whole 5 cm piece in one sitting.

The reaching tray was replaced with the single pellet precision reaching shelf. The pups appear to be hesitant about stepping on the floor, possibly since the floor is clear plexiglas. No reaches were recorded on this day, but the pups did all eventually explore the area.

**P26:** Pups are reaching for the banana pellets through the precision reaching slot (Fig. 15). The dominant paw is lifted off the floor with the digits semi-flexed. The elbow brought to midline, and the nose oriented into the slot. The arm is brought up and extended in through the slot and searches for a food pellet. When the paw came in contact with a pellet it was then grasped and the arm retracted while supinating the wrist. The other paw is then brought up and the food placed in the mouth. The pups then dodge from the slot and run down to the nest area. All pups demonstrate a mature reaching pattern by this age.

Pasta is still not eaten in an adult-like manner. The pasta is dropped most of the time, and the paws still adopt a symmetrical holding pattern, even when the pasta is long.

**P27:** Pasta eating has become fairly normal (Fig. 16). Pups have a more symmetrical grip than the adults, and some give up eating the pasta quickly. Pasta flipping has decreased in frequency. Some pups have a mature asymmetrical paw holding pattern in that the lower paw has the pasta in a power grip with only the tips of the other digits touching the pasta. The pup is also using the lower paw to feed the pasta into the mouth rather than the



## Bimanual Coordination

57

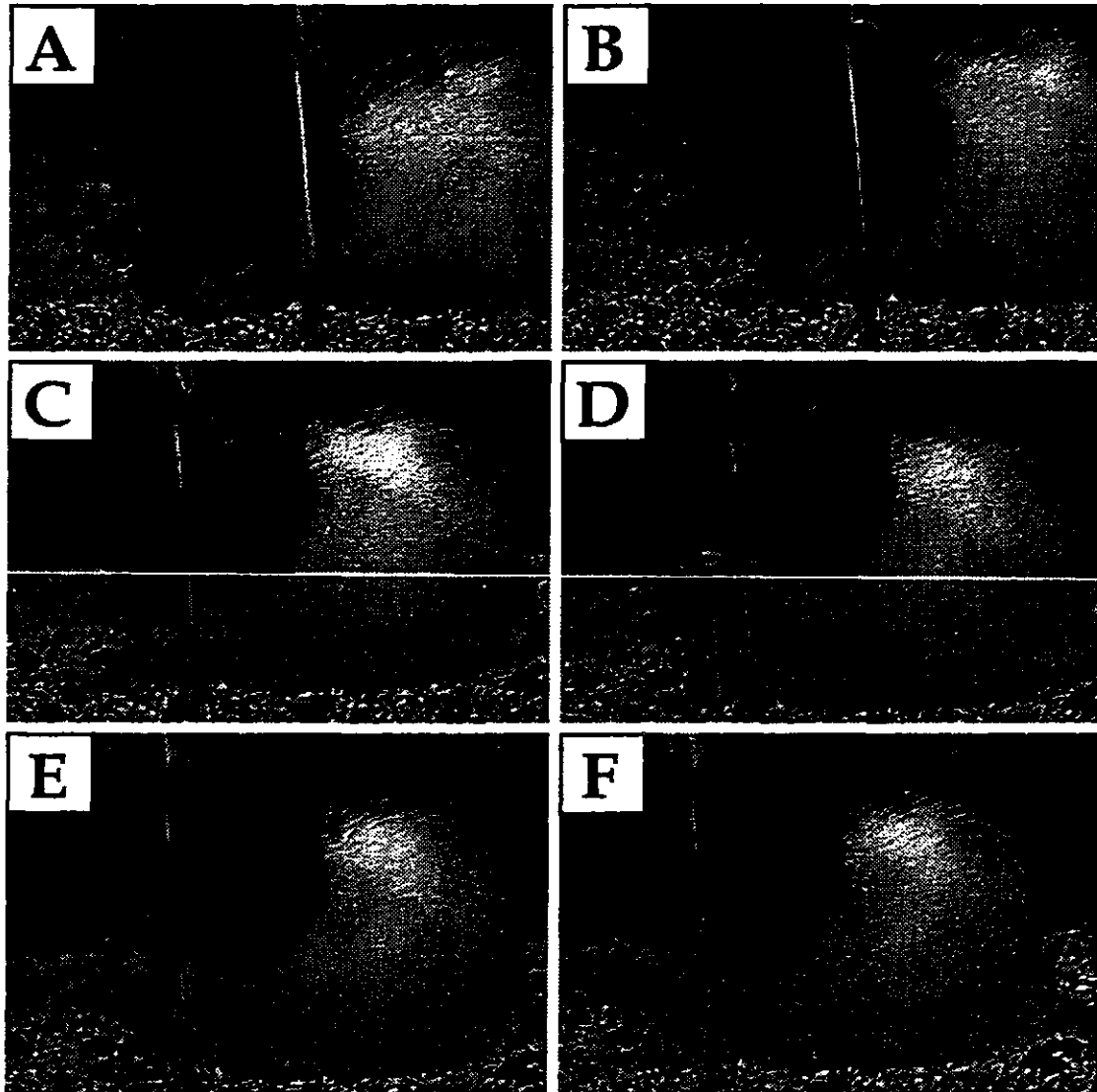

**Figure 16.** Bimanual coordination (P30). A. The rat picks up the pasta. B. The pasta is placed into the mouth. C. The pasta is positioned with the lower paw holding it in a power grip and the upper paw holding it in a precision grip to guide it into the mouth. D. The lower paw feeds the pasta up to the mouth. E. The lower paw is repositioned lower down on the pasta. F. The paw feeds the pasta up to the mouth.

## Precision Reaching

58

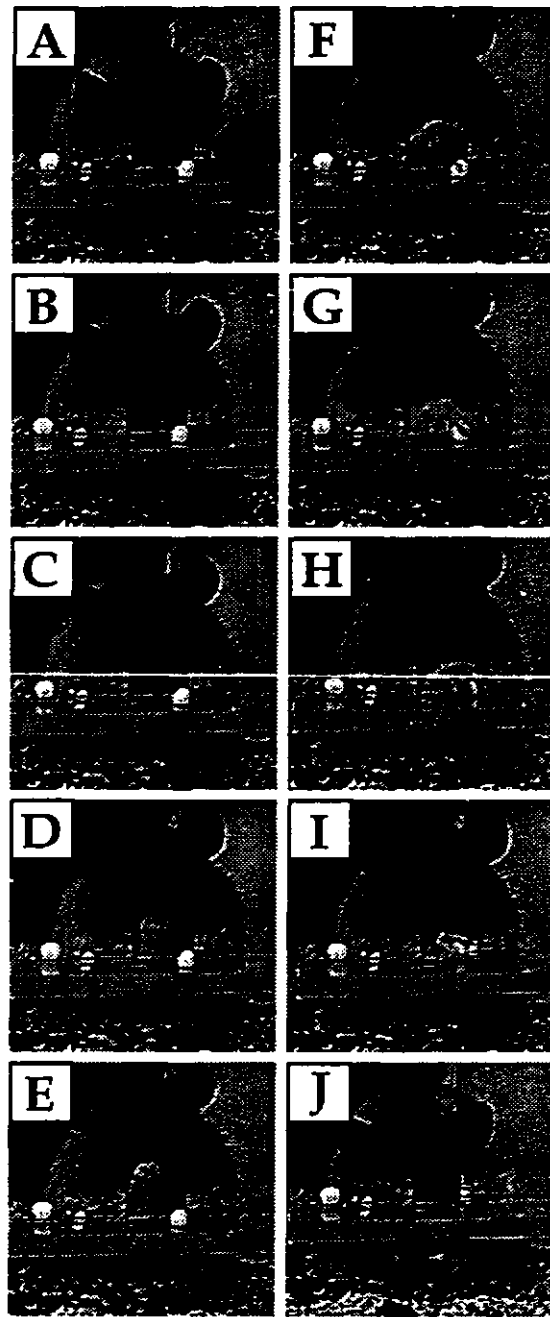

**Figure 15.** Precision reaching. A. Align snout and body perpendicular to slot. B. Paw is lifted off the ground. C. Elbow comes into midline of the body. D. Paw is aligned to reach through slot. E. Forelimb is extended through slot. F. Digits are opened to grasp pellet. G. Pronation of forelimb and align paw over pellet. H. Grasps pellet. I. Supination and retraction of the forelimb. J. the forelimb is supinated again and the rat eats the pellet.

teeth pulling the pasta up through the paws.

During precision reaching, the pups are using the adult pattern of reaching, but are inaccurate when forced to reach for only one pellet. It takes most pups more than one try to successfully grasp a single pellet off of the shelf and get it to their mouth to eat it. Much of this inaccuracy may stem from the fact that there is more than one pup attempting to reach through the slot at the same time, forcing them to come into the slot at an angle rather than straight in.

**P28:** A few pups are still not using an adult-like pattern in order to eat the angel hair pasta. One pup uses the floor as a block to keep the pasta in one spot and then eats down towards the floor, and has its paws in a symmetrical pattern only being used for stability and guidance.

Single pellet reaching is very successful after the first couple of reaches when the banana pellets are first available, most pups are able to get the pellet in the first attempt and if they miss the first time generally get it in the next reach.

**P29:** Many pups are still carrying more than one banana pellet to the nest. Reaching behaviour has become very accurate, but a few of the pups are unable to eat the pasta using an asymmetric paw holding pattern.

**P30:** All pups seem to be eating the angel hair pasta using the mature asymmetrical paw holding pattern. The pups are using the lower paw as a dominant paw, using it to push the pasta up into the mouth while the upper paw is holding the pasta in a precision grip and guiding the pasta. All the behaviours have reached mature stereotypic levels by P30.

### III. Statistical Summary

The first litter of pups were studied to establish the parameters of the experiment and are not included in the statistical summary since individual pups were not identified. The subsequent two litters were culled down to 6 pups, but one pup died, bringing the total number of pups for statistical analysis to 11. As each rat demonstrated one of the behaviours of interest the incidence was recorded. Once a behaviour was recorded for each of the eleven pups it was summarized (Fig. 17). The results were then converted into percentages by taking the number of rats at each age that display the behaviour of interest by the total number of rats in the experiment (Fig. 18). This figure reflects the rate of maturation of each of the behaviours of interest, demonstrating either that they may emerge quickly, or progress at a more gradual rate.

### CONCLUSION

The development of behaviour was recorded and a chronological timeline of emergence of certain behaviours was established. The appearance of the behaviours seems to follow the rostrocaudal gradient of maturation with the forelimbs leading hindlimb maturation by a few days. The present study shows that behaviours involving all four limbs being primarily on the ground mature quicker than behaviours that require that the rat stand only on its hindlimbs.

Certain behaviours, such as eye-opening, food sniffing, and the ability to eat hard food are precursors to the behaviours of interest. These events are necessary for the emergence of motor behaviours related to eating solid food.

| Behaviour                | Postnatal Age |    |    |    |    |    |    |    |    |    |    |    |    |    |    |    |
|--------------------------|---------------|----|----|----|----|----|----|----|----|----|----|----|----|----|----|----|
|                          | 15            | 16 | 17 | 18 | 19 | 20 | 21 | 22 | 23 | 24 | 25 | 26 | 27 | 28 | 29 | 30 |
| Eyes Open                | 6             | 11 |    |    |    |    |    |    |    |    |    |    |    |    |    |    |
| Food Sniffing            | 4             | 11 |    |    |    |    |    |    |    |    |    |    |    |    |    |    |
| Eat Hard Food            | —             | 11 |    |    |    |    |    |    |    |    |    |    |    |    |    |    |
| Robbing                  | —             | —  | 2  | 2  | 8  | 8  | 8  | 11 |    |    |    |    |    |    |    |    |
| Carry-to-eat             | —             | —  | —  | —  | 2  | 11 |    |    |    |    |    |    |    |    |    |    |
| Begin Eating Pasta       | —             | —  | 1  | 1  | 4  | 9  | 9  | 10 | 10 | 11 |    |    |    |    |    |    |
| Carry >1 Pellet          | —             | —  | —  | —  | —  | —  | —  | —  | 3  | 10 | 11 |    |    |    |    |    |
| Reaching (chicken feed)  | —             | —  | —  | —  | —  | 1  | 2  | 2  | 6  | 11 |    |    |    |    |    |    |
| Carry-to-leave           | —             | —  | —  | —  | —  | —  | —  | —  | —  | —  | 5  | 11 |    |    |    |    |
| Reaching (single pellet) | —             | —  | —  | —  | —  | —  | —  | —  | —  | —  | 3  | 11 |    |    |    |    |
| Dodging                  | —             | —  | —  | —  | —  | 1  | 1  | 1  | 3  | 3  | 4  | 9  | 9  | 11 |    |    |
| Upright Posture          | —             | —  | —  | —  | —  | —  | —  | —  | —  | —  | 3  | 3  | 6  | 8  | 11 |    |
| Adult-like Pasta Eating  | —             | —  | —  | —  | —  | —  | —  | —  | —  | —  | —  | —  | —  | —  | 4  | 11 |

Figure 17. Quantification of behavioural development. The number of rat pups that display each behaviour is shown for each age, the quantification is based on two litters of pups (one litter had 3 males and 3 females, the other litter had 3 males and 2 females, therefore there is 11 pups in this analysis).

## Behavioural Development

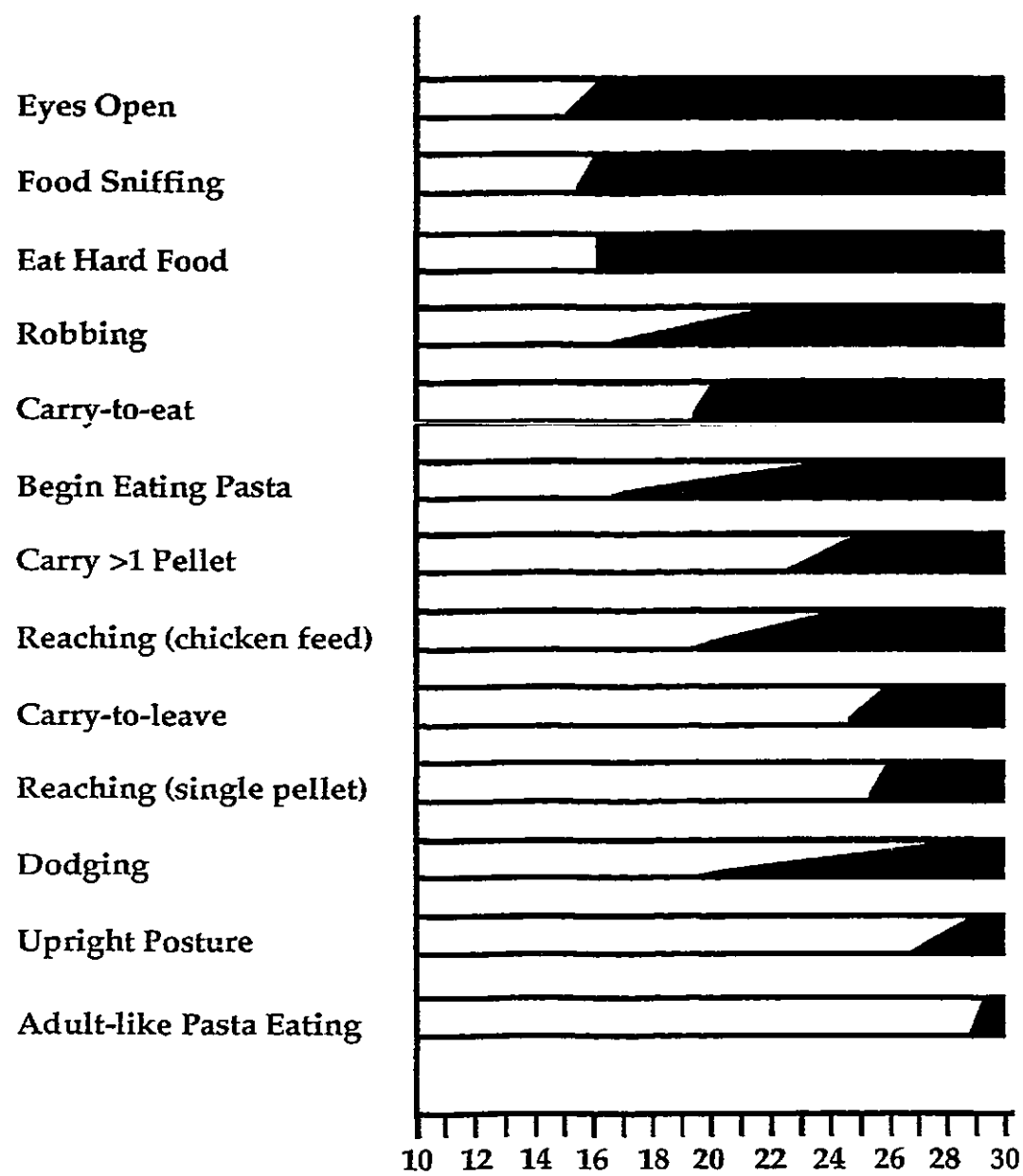

Figure 18. Behavioural Timeline Summary

The eyes opened over the space of two days, from P15 to P16, which is supported by a study by Altman and Sudarshan (1975) who showed that Purdue-Wistar rats opened their eyes at P15. During this same period of time the pups were showing signs of food sniffing behaviour, which ultimately led to the pups attempting to eat the rat chow pellets, which the dam had brought down to the nest, by P16. Bolles and Woods (1964) also report that sniffing and eating behaviour of the Sprague-Dawley rats show the same developmental sequence as the Long-Evans rats used in this study. Thus, the precursor behaviours to feeding related behaviours are in place by P16.

Different behaviours show different maturation rates. Behaviours such as suckling and forepaw kneading movements are already mature when the pups are born, demonstrating a quick maturation rate (Hall, Cramer & Blass, 1977). Other behaviours such as locomotion (Altman & Sudarshan, 1975), claw cutting (Whishaw, Kolb, Sutherland & Becker, 1983), and contact righting (Pellis, Pellis & Teitelbaum, 1991) take long periods of time to mature into adult-like behavioural patterns. This difference in the emergence and maturity of behaviour may be due to the sequence of maturation of the central nervous system. The brain develops in a rostrocaudal gradient, therefore the mouth and forelimbs will mature before the more caudally located hindlimbs receive their spinal cord connections. The coordination of the various motoric behavioural patterns may then require a longer period of time to develop. Forelimb grooming movements can be seen just hours after birth, but the animal is unable to sit up on its haunches in order to execute the mature pattern since it is unable to support the upper body on its

hindlimbs (Golani & Fentress, 1985). Different elements of a behaviour may show up early and other elements late, which contributes to a long maturation process. Learning to combine or integrate skills also may contribute to a drawn out maturation process. The maturation of the neural connections and the area of the cortex responsible for the integration of movement patterns is evident through development until the adult-like behaviours can be accomplished.

The first behaviours to emerge and mature into an adult-form are the behaviours that require minimal postural support on two limbs. Robbing is the first behaviour to emerge after the animal begins to eat hard food from P17 to P22, a span of six days. This behaviour requires the ability to locomote on four limbs, and use their mouth to steal the food. Carry-to-eat and carry-to-leave behaviours also require locomotory movements on four limbs. To perform these behaviours the rat picks up a piece of food with the mouth and then runs to a safe place with it. These behaviours are carried out using all four limbs for support with no skilled movements of the forelimbs being necessary.

When the animals use skilled movements, such as reaching and bimanual coordination of the forelimbs, they use the hindlimbs for support. After the emergence of these behaviours, they undergo an extended period of development until the mature form of the behaviour is manifested. Reaching behaviour is first seen on P20, and takes five to seven days to mature, P24 for tray reaching and P26 for precision reaching. Pasta eating is not mature until P30, which makes it the behaviour that has the longest



maturation process of fourteen days. To reach, a rat shifts the majority of its weight onto the hindlegs, but still uses one forelimb for postural support while the other limb is executing the actual reaching movement. In the last behaviour to emerge, pasta eating, the animal must support its weight using only the hindlegs while the forelimbs are being used to manipulate a piece of pasta. Postural support depends upon the ability of the body to first have the connections to control the muscles that are responsible for the posture and the ability to have the muscles work simultaneously to prevent swaying or jerking motions to keep balance. Both of these behaviours require the rats to be able to use some form of hindlimb postural support.

During reaching and pasta eating, postural support is important, but pasta eating takes six days longer to mature than reaching. This difference may be due to the difference in the postures required, but may also be due to the skills required. Reaching uses precise motor movements in one forelimb such as pronation, grasping and supination. Pasta eating requires bimanual coordination of the forelimbs in that the rat uses a precision grip with one paw and a power grip with the other paw to feed the pasta into the mouth. To successfully eat pasta, each paw uses different movements in coordination, which is in contrast with the reaching movement that only requires the skilled movements of one forelimb. To eat the pasta, the cortex must integrate the information from both limbs and coordinating their movements. The behaviours of reaching and pasta eating, demonstrate that even when the postural support may be there, there must still be an integration of information from the two hemispheres to achieve the mature

behaviour pattern.

These findings show that behavioural development follows a gradual progression from simple tasks such as the ability to eat hard food to tasks that require complex movement sequences such as pasta eating. Motor coordination takes a relatively long time for the rat pups to master and may involve some form of learning to coordinate complex movements with postural adjustment. During development, animals must overcome many hurdles such as the ability to control body posture and integrate information being received from one side of the body with information from the other side, as seen in bimanual coordination. The results of this study imply that each behaviour may follow an orderly timeline with one behaviour being dependent upon others. The cerebral cortex may be involved in the integration of these behaviours with the forelimb area of the motor cortex being one of the more likely areas to be involved.

### Chapter 3: Anatomical and Biochemical Markers of Development

The developing brain is fundamentally different in apparent organization than the adult brain. Early on in development the cortex appears fairly uniform, lacks specificity in cytoarchitecture and connections, and therefore is flexible. However, once its general input-output organization is determined it is almost impossible to reorganize the cortex in any drastic way. There is a basic 6 layer pattern, but the architecture across the cortex is variable with distinct areas showing common cell sizes, densities, and cortical connections. Nevertheless, during development the brain still changes. Different chemical compounds are being formed in varying concentrations and discrete areas of the brain are becoming functional and eventually become more efficient in coding information. Through advances in staining technology the capability to localize and identify many of the different compounds in the brain has become possible.

The following set of experiments were conducted to measure the developmental progress of the forelimb area of the motor cortex. The developmental days were chosen to represent relevant days through behavioural development up to adulthood. Skilled motor behaviours are not displayed by the rats until after P15, therefore P10 was used as a baseline measurement in the forelimb area before any skilled motoric behaviours are expressed. The biological indexes of forelimb area development were: I. Cortical thickness, II. Morphology of Layer III pyramidal neurons, III. GFAP-immunoreactivity, IV. Myelination, V. c-fos-immunoreactivity, and VI.

Acetylcholinesterase activity.

During postnatal growth of the rat cerebral cortex the volumetric growth pattern shows a dramatic growth within the first 3 weeks and then slowly increases to adult levels by day 60 (Van Eden and Uylings 1985). An asymmetric growth between the hemispheres is also noted (Diamond, 1987, and Van Eden, Uylings, and Van Pelt, 1984). The cerebral cortex of the rat is sexually dimorphic in adulthood, both in gross size of the cortex and at the cellular level. Diamond (1987) showed that male Long-Evans rats have a greater cortical thickness in the right hemisphere compared with the left and this difference is visible from postnatal day 6. Females, however, do not show this asymmetry between hemispheres (Stewart and Kolb, 1988). It has been shown that male rats have a larger cerebral cortex in cross-sectional area as well (Pfaff, 1966, Yanai, 1979). Sex differences in morphological size have been shown in the primary motor cortex, forelimb area of the sensorimotor cortex and in the monocular and binocular areas of the visual cortex (Reid & Juraska, 1992).

Neurons are the building block of the brain. They are able to interact or communicate with other neurons and support cells mainly through chemical messengers. They are aggregated into communities that function to control or modulate different behavioural outputs. During development most of these communities are not yet functional since they have not made the proper synaptic connections. Pyramidal cells, a type of spiny neuron, found in Layers II, III, V and VI of the cortex, are the efferent projection neurons of the cortex. Layers II and III are small and communicate with other cortical

regions, including the opposite hemisphere. Layers V and VI are the largest cells and project to the brainstem and spinal cord (Kolb & Whishaw, 1995). The cortico-cortico neuronal projection is relevant to this thesis since bimanual coordination requires that the two hemispheres be in constant communication to mediate the movements of the forelimbs in concert with one another.

Nearly all rat cortical neurons are generated before birth, with the exception of a few Layer IV neurons (Petit, et al, 1988). They do not establish their adult morphology until they have reached their final destination. Dendrites are formed early in development as well, with no new ones being formed after P7 - 10 in rats. Once dendrites have bifurcated during development, all further growth occurs at the tip of the dendritic segment (Petit, et al, 1988). In rats, Layer V pyramidal cells reach their destination by P10 and display adult morphology by P20, but do continue to increase in the length of their terminal dendritic branches at the tips until adulthood (Petit, et al, 1988). One purpose of this experiment is to characterize the development of Layer III pyramidal neurons in the FL area of the cortex of the rat. It is suspected that their morphological development should follow the rules governing the development of the Layer V pyramidal neurons.

Brain function is dependent upon an intimate neuron to glia interaction and signalling. Glia are involved in maintaining neurons, regulating metabolism, and regulating ion homeostasis (Largo, et al, 1996). Glial cells and neurons mutually influence the differentiation, development and metabolism of their counterpart (Barres & Raff, 1993; Georgiou, et al,

1994; Murphy, et al, 1993; Shao & McCarthy, 1994). Astrocytes are also involved in guiding migrating neurons and growing axons (Rakic, 1981; Hatten, 1990 and Rakic, et al, 1994), to modulate neuronal differentiation (Chamak, B. et al., 1987 and Seil, et al., 1992) as well as modulating hormonal messages throughout the nervous system (see review: Garcia-Segura, et al. 1996). Neuronal growth and differentiation is thought to be regulated by astrocytes through the release of neurotrophic factors (Banker, 1980; Stichel, Müller & Zilles, 1991).

Astrocytes are identified by the expression of glial fibrillary acidic protein (GFAP), which is a specific component of glial intermediate filaments. GFAP accumulates in astrocytes during development, in a caudal to rostral gradient of expression which is consistent with brain maturation (Kálmán & Hajós, 1989; and Landry, Ivy & Brown, 1990). The first expression of GFAP-immunoreactivity is seen at embryonic day 16 and peaks around P15, with high expression stable throughout adulthood (Landry, Ivy & Brown, 1990). From P5 until P20, in the rat, astrocytes show a steady increase in GFAP-immunoreactivity and the distribution is uniform throughout the cortex (Kaur, Ling & Wong, 1989). Astrocytes proliferate until the second or third week after birth in cortical grey matter (Ling & Leblond 1973, Parnavelas, et al. 1983), whereas it increases continuously in the white matter throughout life (Sturrock, 1986). GFAP is involved in the development of the cytoskeleton of mature astrocytes and therefore can be used as a marker of maturity in the cerebral cortex.

Oligodendroglia are a type of macroglia found in the brain that

functions as a specialized support cell. They are small cells with relatively few processes, which are wrapped concentrically around the axon in a tight spiral to maintain the integrity of the myelinated axon. The myelin sheath on nerve cells is able to speed the nerve impulse by facilitating the conduction of electrical signals down the axon (Kandel, Schwartz & Jessell, 1991). They may also modulate neuronal metabolism, as do astroglia (Garcia-Segura, Chowen & Naftolin, 1996).

During development, oligodendrocytes are the last type of glial cells to appear and the expression of the genes in oligodendrocytes for myelination is dependent upon the presence of astroglia (Kandel, Schwartz & Jessell, 1991). From P5 until P20, oligodendrocytes show a steady increase which parallels astrocytic proliferation (Kaur, Ling & Wong, 1989). They grow in significant numbers in the corpus callosum immediately before the onset of myelination at postnatal day 12 (Sturrock, 1976). Myelination facilitates neuronal communication, therefore, the maturation of skilled movements may require mature myelination in the forelimb cortex for effective movements.

Cortical development and plasticity are thought to be based upon activity dependent modulation of gene expression. Immediate early genes (IEG's) are thought to be responsible for the mediation of the long-term responses of the neuron to trans-synaptic signals. They encode regulatory proteins that control the expression of late response genes. One of the IEG's to be expressed following activity of neurons is *c-fos*, which has been implicated in developmental events such as cell growth and differentiation (Sheng & Greenberg, 1990, Alcantara & Greenough, 1993). *c-fos* is part of the

heterodimer with c-Jun acting as a transcription factor at the AP-1 binding site, which has been associated with plasticity in the cortex during development (Bohmann, et al, 1987, Curran & Franza Jr., 1988, Distel & Spiegelman, 1990, Kaminska, B, et al, 1995). Kaminska and colleagues (1995) demonstrate that the AP-1 binding activity shows peak expression around P21 in rats. Depending upon which jun partner fos connects with determines the role they have at the AP-1 binding site. If c-fos and c-jun bind then they will act as a transcriptional activator, but if Fos and Jun-B link they act as a transcriptional repressor (Sheng & Greenberg, 1990). The induction of c-fos is rapid, but transient, and is considered a marker of recent or ongoing cell activity since it is expressed within minutes after a stimulus and has a half life of 30 minutes (Sheng & Greenberg, 1990). The expression of c-fos in the quiescent brain is very low or is undetectable, but a large number of stimuli are able to induce c-fos expression including mitogens, differentiation-specific agents, pharmacological agents and by sensory stimulation or physiological stressors (Alcantara & Greenough, 1993, Miura, Takayama & Okada, 1994).

In lesion studies it has been noted that c-fos is inducible in neonatal cortex after brain injury, but not in adult rodent brains (Ruppert & Wille, 1987). Mechanical injury at P15 causes the rat cortex to respond in a different manner than injury at P20 to adulthood (Herrera, Figueiredo & Cuello, 1993). Since there is differential expression in developing and mature brains in expression of c-fos and other IEG's, c-fos must play an important role in the process of development of the brain and possibly in adult synaptic plasticity.

The cholinergic system appears to develop largely postnatally in the



cerebral cortex (Kiss & Patel, 1992). Acetylcholinesterase is found in the cortex around P5, when it is localized in layer VI, and by the second postnatal week is found in layer IV. By approximately P28 acetylcholinesterase levels are indistinguishable from the adult rat (Kiss & Patel, 1992). The cholinergic system is thought to be involved in the plasticity and development of the synaptic connectivity in early life, have an influence on the long-term changes associated with synaptic strength in adult systems, and have a state dependent effect on circuit function that is fundamental to the dynamics of ongoing brain activity (Sillito, 1993). Acetylcholine also has a depressing effect on the inhibitory response on interneurons, which causes an excitatory effect in the deep pyramidal cells of the cortex (Krnjevic, 1988). Therefore, acetylcholine may be involved in the excitation of pyramidal neurons during motor movements.

In this thesis, the forelimb area of the motor cortex will be anatomically and biochemically analyzed. The different biological markers may indicate when this area becomes mature and capable of mediating behaviours that require skilled movements.

#### GENERAL METHODS

The methods that are common across all biochemical markers are given first, and then, since each of the individual markers follows a different staining and quantification protocol, each will be discussed separately.

### *Animals*

Four male and four female Long-Evans Hooded rats were obtained from the University of Lethbridge breeding colony at each of the following ages: Postnatal day (P) 10, 15, 20, 25, 30, and 90. The pups were housed with their dams in Plexiglas cages with bed-o-cob bedding until P25 at which time they were transferred to the main colony and housed in hanging wire mesh cages. They were kept on a 12:12 light/dark cycle with the lights out at 19:30. They were fed ad libitum with standard rat chow and had free access to water.

### *Histology*

The rats were first anaesthetised with Euthanyl (MTC Pharmaceuticals) and sacrificed by perfusion through the left atrium, with 0.9% phosphate buffered saline (PBS) that was allowed to exit the body through a cut in the right ventricle. The solution was run through the body until the blood ran clear and was then followed by phosphate buffered Lana's fixative (picric acid/paraformaldehyde).

Following overnight post-fixation in the final perfusate solution, 30 $\mu$ m coronal sections were cut using a vibratome (Series 1000 Sectioning System) and stored in 0.1 M phosphate buffer (PB) in centrifuge bottles until the staining procedure could be performed.

### *Staining Methods:*

#### **I. Cortical Thickness**

The brain sections were mounted onto 0.5% chrome alum-gelatin

slides and allowed to air dry. They were stained using Fisher Histomatic Slide Stainer Model 172 and were processed through 15 solutions: (1) distilled water, (2) 70% alcohol, (3) 95% alcohol, (4) 100% alcohol, (5) Hemo-de™, (6) 100% alcohol, (7) 95% alcohol, (8) 70% alcohol, (9) distilled water, (10) Cresyl Violet stain, (11) distilled water, (12) distilled water, (13) Acetic acid - alcohol destain, (14) 100% alcohol, (15) Hemo-de™. The slides were then coverslipped using Permount™ immediately after removal from the Hemo-de™.

*Quantification:*

Cortical thickness was measured as the shortest distance from the top of layer I to the bottom of layer VI across the forelimb area of the cortex from drawings done at 20X power on a magnifying projector. Two measurements from each cerebral hemisphere were taken at two coronal planes in the forelimb area (Fig 19). Care was taken to make comparable measurements on the two sides of the brain, matching subcortical landmarks.

## **II. Morphology of Layer III pyramidal neurons**

*Animals:*

Two male and two female Long-Evans Hooded Rats at each of the ages P10, P20, P25, P30 and P100 were sacrificed with Euthanyl (MTC Pharmaceuticals) and perfused through the left atrium with 0.9% saline until the blood exiting through a cut in the right ventricle was clear.

## Cortical Thickness

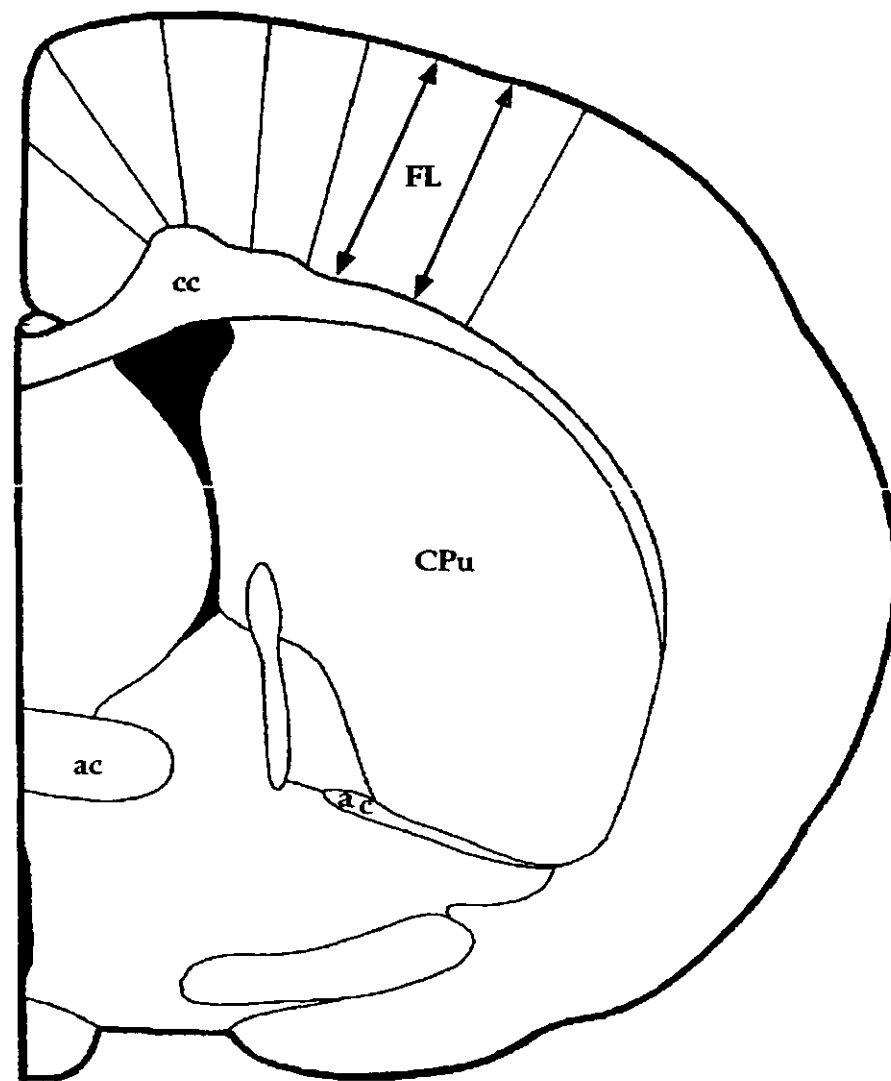

**Figure 19.** Coronal section of rat cortex where measurements of cortical thickness of the FL area (Bregma 0.3 mm) were taken, which are indicated by the double headed arrows. (The areas are named according to Zilles, 1985). FL - forelimb sensorimotor cortex, cc - corpus callosum, CPu - caudate putamen, and ac - anterior commissure.

*Staining Method:*

The brains were extracted and immersed in 20 ml of Golgi-Cox solution where they remained for 14 days. Brains were then placed into 30% sucrose for at least 3 days before being sectioned at 200 $\mu$ m on a Vibratome. Slices were mounted on 2% gelatin-coated slides and developed according to the method of Kolb and McLimans (1986).

*Quantification:*

The basilar and apical tree of layer III pyramidal cells in the forelimb area of the motor cortex were drawn at a magnification of 200X using camera lucida. In order to be included in the analyses, the neurons had to meet the set of criteria defined in Kolb and Gibb (1993). Five pyramidal cells were drawn in each hemisphere of each animal from Layer III of Zilles (1985) forelimb (FL) area of the cortex. The number of branches at each order were counted. According to the method of Coleman and Reisen (1968), branches leaving the cell body were defined as first order, after one bifurcation, second order and so forth. Dendritic branching was also quantified by the ring intersection method of Sholl (1956). A series of concentric rings 20 $\mu$ m apart was placed over the camera lucida drawing of the basilar and apical field of the cell and the number of dendritic intersections with each ring was counted (Fig. 20).

## Sholl & Branch Order Analysis

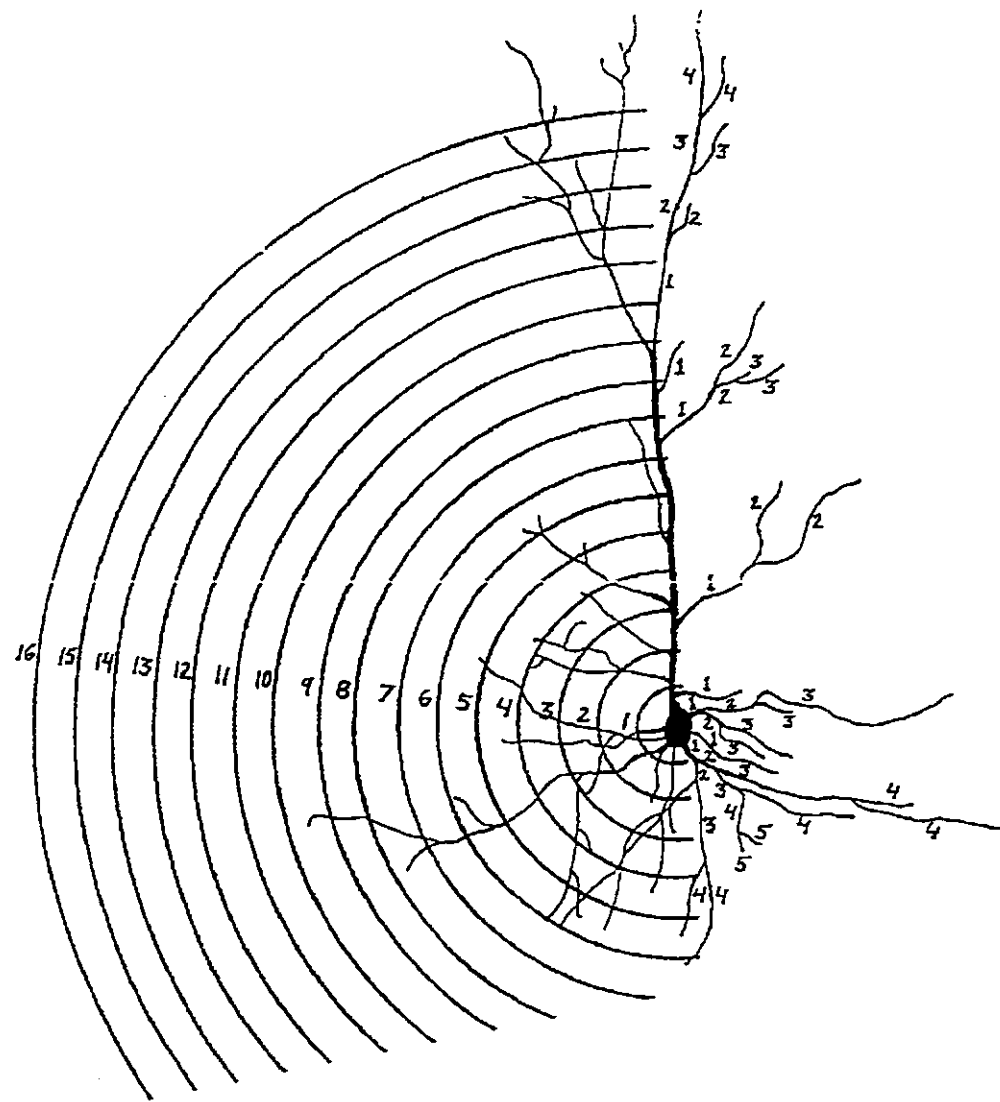

**Figure 20.** Representation of Sholl and Branch Order analysis on a Pyramidal Cell. In Sholl Analysis each concentric circle represents 20µm from the previous circle. For Branch Order Analysis each bifurcation of the dendrites from the soma has a higher branch order number.

## Stereology & Densitometry

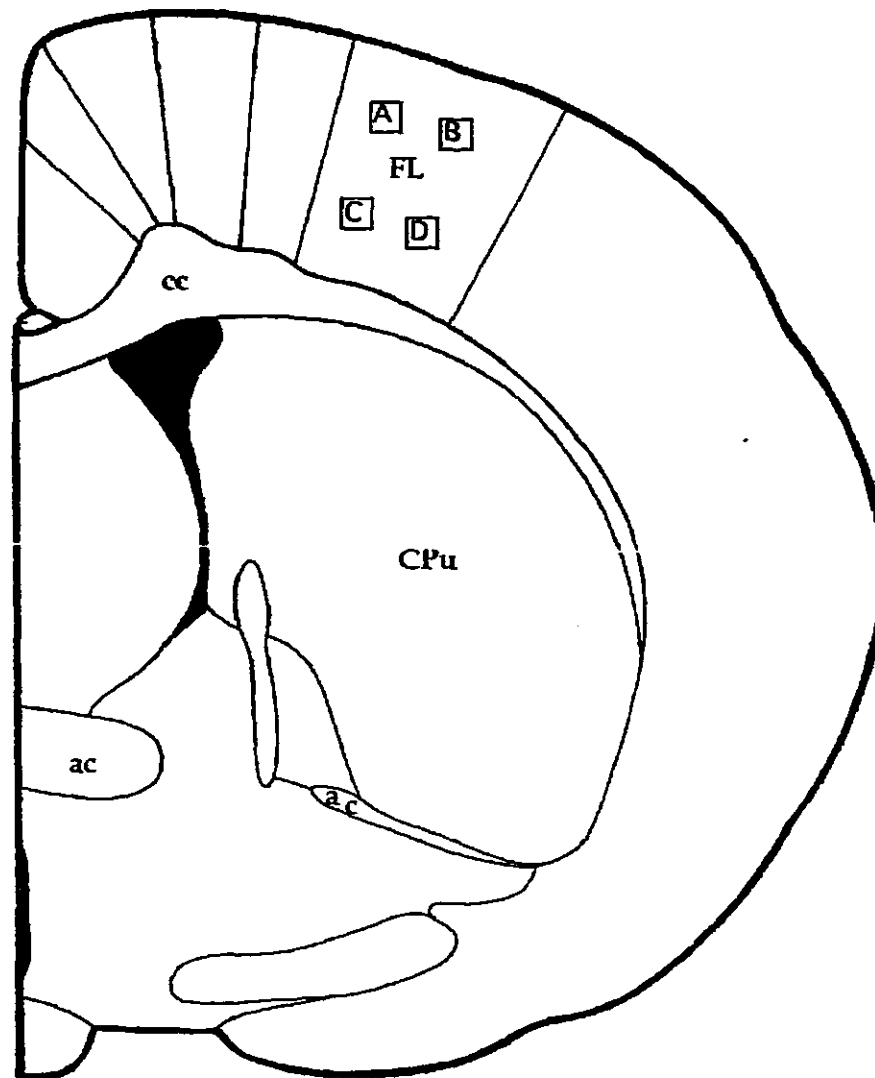

**Figure 21.** The plane of coronal section where measurements were taken from superficial (A, B) [roughly corresponding to Layers II/III] and deep layers (C, D) [roughly corresponding to Layers V/VI] of FL area were taken. (The areas are named according to Zilles, 1985). FL - forelimb sensorimotor cortex, cc - corpus callosum, CPu - caudate putamen, and ac - anterior commissure.

### III. GFAP-immunoreactivity

#### *Staining Method:*

The brain sections were washed in PB in Pyrex Coors trays, and then placed in blocking solution for 30 minutes. The sections were transferred to the primary antibody for GFAP for one hour and then washed again. The sections were then incubated in secondary antibody for 30 minutes and washed. The sections were then transferred into the ABC (Vector Laboratories Inc) reagent for 30 minutes and washed in PB. They were then stained in the DAB (Vector Laboratories Inc) reaction for 5 minutes or until desired staining intensity was reached and then washed in PB to stop the reaction. Negative primary and negative secondary antibody controls were used. The sections were mounted out of tap water onto 1.0% gel slides and allowed to air dry. They were then rehydrated with the cytochemical clearing agent Hemo-de™ and then coverslipped using Permount™.

Due to variations in background staining, the GFAP-stained tissue could not be analyzed reliably using an automated imaging system. An unbiased estimate of the surface density of GFAP-immunoreactive material was calculated using a stereology workstation. This workstation utilized an Amiga 2000 computer connected via a video camera to a Zeiss microscope, and used the software GRID (Medicosoft). A stereological grid consisting of a number of test lines was superimposed over the area of interest. The number of intersections between GFAP-immunoreactive material and the test lines were counted (magnification of 200X), and the surface density was calculated



using the following formula:  $S_v = 2[\sum I / (l_p)(\sum P)]$

where  $\sum I$  is the total number of intersections of the test lines with GFAP-stained material,  $\sum P$  is the total number of test points sampled, and  $l_p$  is the length of the test line associated with each point in each frame.

Measures of GFAP-immunoreactivity were taken from both superficial (roughly corresponding to the level of layers II/III) and deep (roughly corresponding to the level of layer V) layers from both right and left hemispheres in the forelimb area of the motor cortex (Fig. 21).

#### IV. Myelination

##### *Staining Method:*

The brain sections were mounted on 0.5% chrome alum-gelatin slides and allowed to air dry. The slides were then immersed in the Schmued Gold Chloride staining solution and placed in an oven at 60-70°C for 30-45 minutes until desired staining intensity was achieved. The slides were then rinsed in distilled water for 5 minutes and then fixed in 2.5% sodium thiosulfate for 5 minutes. The slides were placed under a slow dripping tap for 30 minutes and then allowed to air dry. The slides were immersed in the cytological clearing agent Hemo-de™ and immediately coverslipped using Permount™.

##### *Quantification:*

The relative density of myelinated fibres in the forelimb area of the motor cortex was quantified using a computerized imaging system consisting

of a Zeiss microscope connected via a video camera to a Macintosh Power PC 7100/66 running the NIH Image program (The NIH Image program is public domain software written by Wayne Rasbaud at the U.S. National Institutes of Health and is available from the internet by anonymous FTP from [zippy.nimh.nih.gov](ftp://zippy.nimh.nih.gov) or on a floppy disk from the National Technical Information Service, Springfield, Virginia (part PB93-504868)). The areas of the FL area measured were taken both from superficial (roughly corresponding to the level of layers II/III) and deep (roughly corresponding to the level of layers V and VI) (Fig. 21). An arbitrary area of tissue, the corpus callosum, was selected and measured to act as a control for the FL area.

#### **V. c-fos-immunoreactivity**

##### *Staining Method:*

The brain sections were transferred into centrifuge bottles containing the primary antibody for Fos and Fos-related antigens (Santa Cruz Biotechnology) and were placed on a shaking table for 24 hours at room temperature. The sections were then transferred to Pyrex Coors trays and washed three times in PB. The sections were then incubated in the secondary rabbit antibody for 30 minutes and then again washed. The sections were then incubated in ABC reagent (Vectastain Laboratories Inc.), for 30 minutes and then washed again. The sections were stained using a DAB reaction for 5 minutes or until desired darkness was reached and immediately washed two times in PB. Negative primary and negative secondary antibody controls were used. The sections were mounted on 1% gel slides and allowed to air

dry. The slides were then immersed in the cytological cleaning solution Hemo-de™ to rehydrate the sections and then immediately coverslipped using Permount™.

*Quantification:*

An unbiased estimate of the total number of Fos-immunoreactive material was calculated using a stereology workstation. This workstation utilized an Amiga 2000 computer connected via a video camera to a Zeiss microscope, and used the software GRID (Medicosoft). The grid was composed of a number of counting frames in which the number of cell bodies displaying positive immunoreactivity were counted (magnification of 200X). Measures of Fos-immunoreactivity were taken from both superficial (roughly corresponding to the level of layers II/III) and deep (roughly corresponding to the level of layer V) layers from both right and left hemispheres in the forelimb area of the motor cortex (Fig. 21). The average across sections gives a relative density across the forelimb area of the cortex.

## VI. Acetylcholinesterase

*Staining Method:*

The brain sections were mounted on 0.5% chrome alum-gelatin slides and allowed to air dry. The slides were then rinsed in 0.9% saline for 5 minutes and then transferred to the iso-OMPA solution (0.0016 mg Tetraisopropylpyrophosphorodiamidic anhydride) for 30 minutes. The slides were then directly transferred to the AChE reaction solution (1.43 g Trisma

maleate buffer, 510.0 mg Trisma base, 25.0 mg acetylthiocholine iodide, 73.5 mg sodium citrate, 37.5 mg cupric sulfate, 8.2 mg potassium ferricyanide, and 50.0 ml distilled water) for 4 hours and then rinsed in distilled water. The slides were then allowed to air dry and then were rehydrated in the cytological clearing agent Hemo-de™, and immediately coverslipped using Permount™.

*Quantification:*

The relative density of AChE in the forelimb area of the motor cortex was quantified using a computerized imaging system consisting of a Zeiss microscope connected via a video camera to a Macintosh Power PC 7100/66 running the NIH Image program (The NIH Image program is public domain software written by Wayne Rasbaud at the U.S. National Institutes of Health and is available from the internet by anonymous FTP from [zippy.nimh.nih.gov](http://zippy.nimh.nih.gov) or on a floppy disk from the National Technical Information Service, Springfield, Virginia (part PB93-504868)). The areas of the FL area measured were taken both from superficial (roughly corresponding to the level of layers II/III) and deep (roughly corresponding to the level of layer V) (Fig. 21). An arbitrary area of tissue, the laterodorsal area of the Striatum, was selected and measured to act as a control for the FL area.

## RESULTS AND DISCUSSION

In this section the results of each of the biochemical marker assays will be discussed. All of the biochemical markers showed significant changes across development. The forelimb area of the motor cortex is volumetrically mature by P15, but layer III pyramidal neurons do not demonstrate morphological mature characteristics until P20 which is the same time that myelination has reached maturity. The astrocytic marker GFAP shows a peak in surface density between P20 and P25, which is immediately followed by a peak in c-fos-immunoreactivity from P25 to P30. Acetylcholinesterase shows an increase in density throughout development up to P25 where it plateaus at mature levels in the female, but male rats do not show mature levels until adulthood. These measurements show that the forelimb area of the motor cortex appears to be developed primarily by P30, but the neurotransmitter ACh may not be established completely in male rats until adulthood.

### I. Cortical Thickness Measurements

In a preliminary analysis, no sex differences were found, therefore the results were pooled thereafter in subsequent tests. There was a significant age effect  $F(5,42)=23.13$ ,  $P<0.001$ . Mature cortical thickness was achieved by P20 in both hemispheres. A small, but significant, left over right asymmetry was found at every age that persisted into adulthood,  $F(1,42)=22.55$ ,  $<0.0001$  (Fig 22). Figure 23 is a pictorial representation of the development of layer banding.

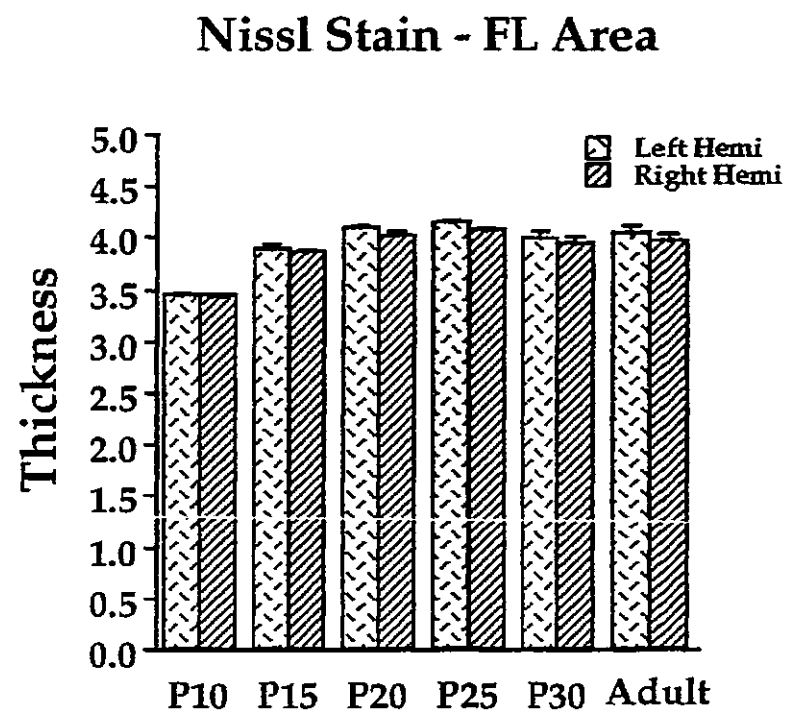
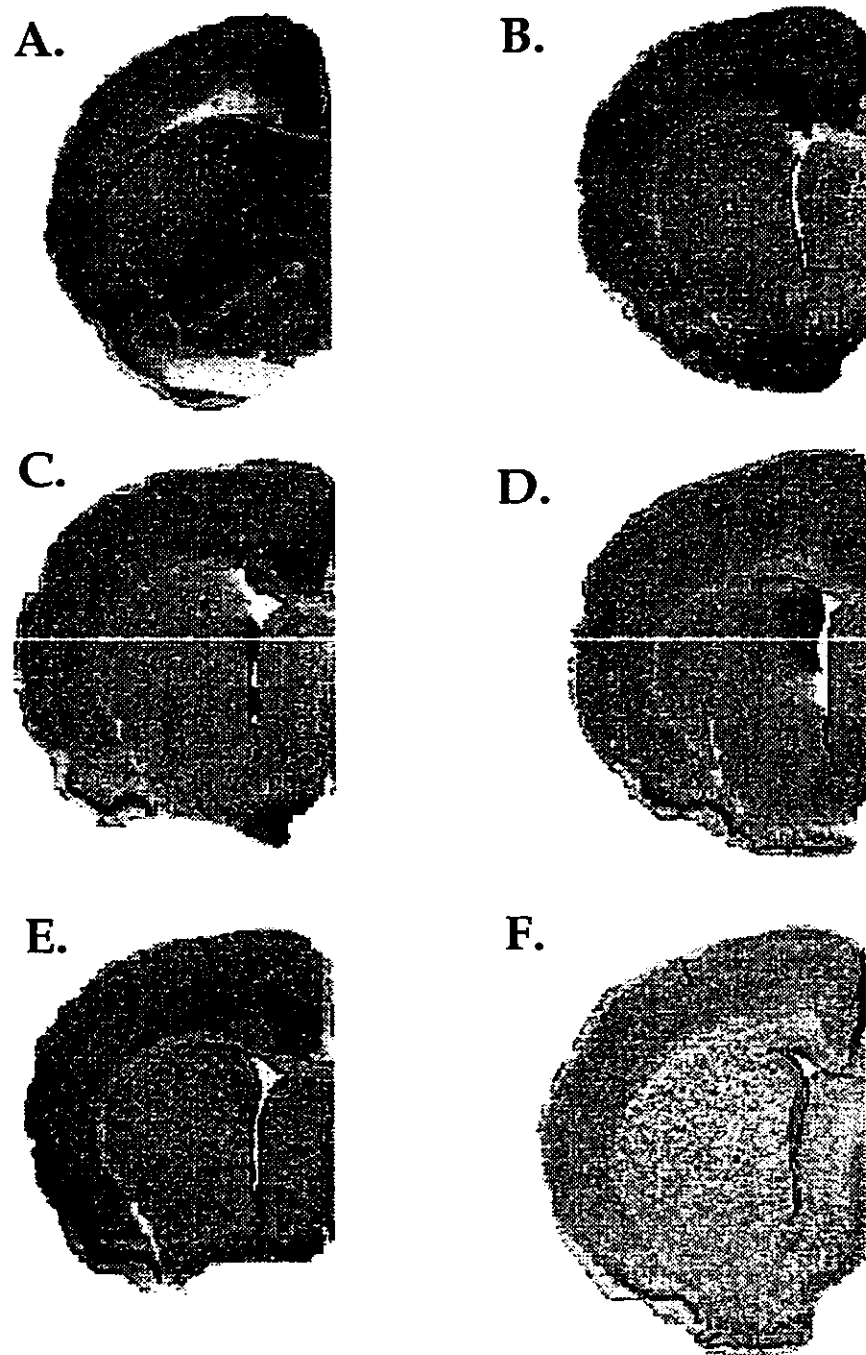

Figure 22. Mean ( $\pm$ S.E.M.) thickness (cm) of the left and right hemispheres in the FL area of the cortex taken from a camera lucida drawn image at a power of 20X.

## Cresyl-Violet Nissl Body Stain

87



**Figure 23.** Cresyl-Violet Stain showing the development of layering and cortical thickness in the FL Area of the cortex. A) P10, B) P15, C) P20, D) P25, E) P30, F) Adult.

The absence of a sex difference in cortical thickness in this study contrasts with previous studies (Pfaff, 1966; Yanai, 1979; Diamond, 1987; Stewart and Kolb, 1988). This discrepant finding may be due to the small sample size used here. Cortical thickness in the FL area reaches comparable levels to adults by postnatal day 20. The banding of the layers seems to be mature by P20 as well, but banding was not quantified. The left hemisphere was consistently larger than the right hemisphere throughout development, which is in agreement with previous studies (Diamond, 1987; and Van Eden, Uylings, & Van Pelt, 1984). The results of this study provide evidence that there is a volumetric difference between the hemispheres, but whether the difference is due to more cells or more neural processes per cell can not be determined.

## II. Layer III Pyramidal Cells

The Golgi-Cox stained material showed that the silver impregnation of cortical neurons was good and that the cells appeared to be completely stained (Fig 24). The measurements from male and female rats were pooled since in preliminary testing of Sholl and Branch Order analysis of the FL area, no sex differences were found across ages.

### *Sholl Analysis:*

According to Sholl concentric ring analysis the Layer III pyramidal cells are mature by P20 as is shown in both basilar and apical dendrites (Fig. 25 A & B). At P10 the pyramidal neurons do not extend up into Layer I and the processes are very short as is shown by ring analysis which accounts for the



## Golgi-Cox Staining of Pyramidal Neuron

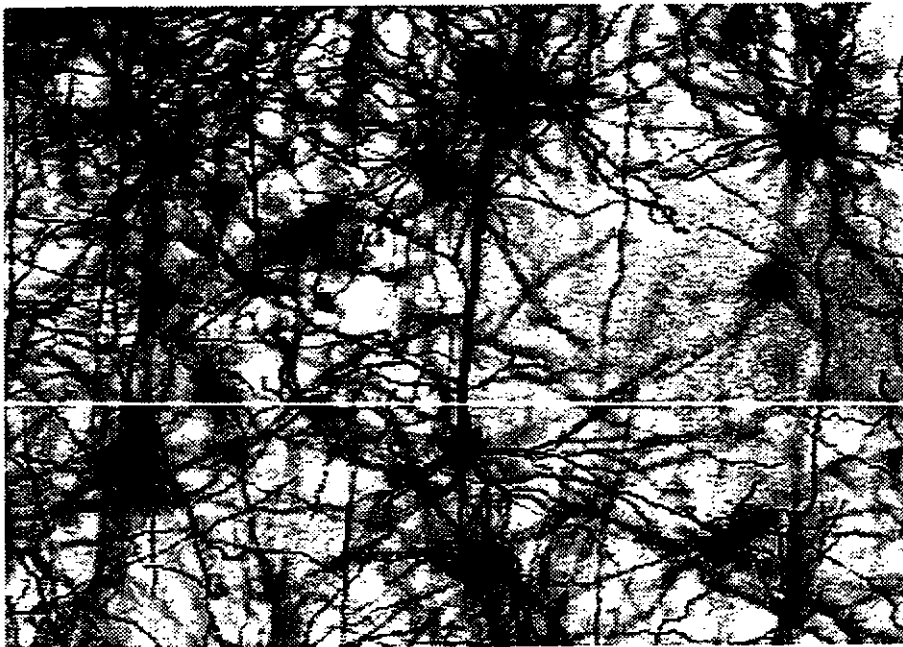

Figure 24. Example of Golgi-Cox staining of pyramidal neurons in the forelimb area of motor cortex.

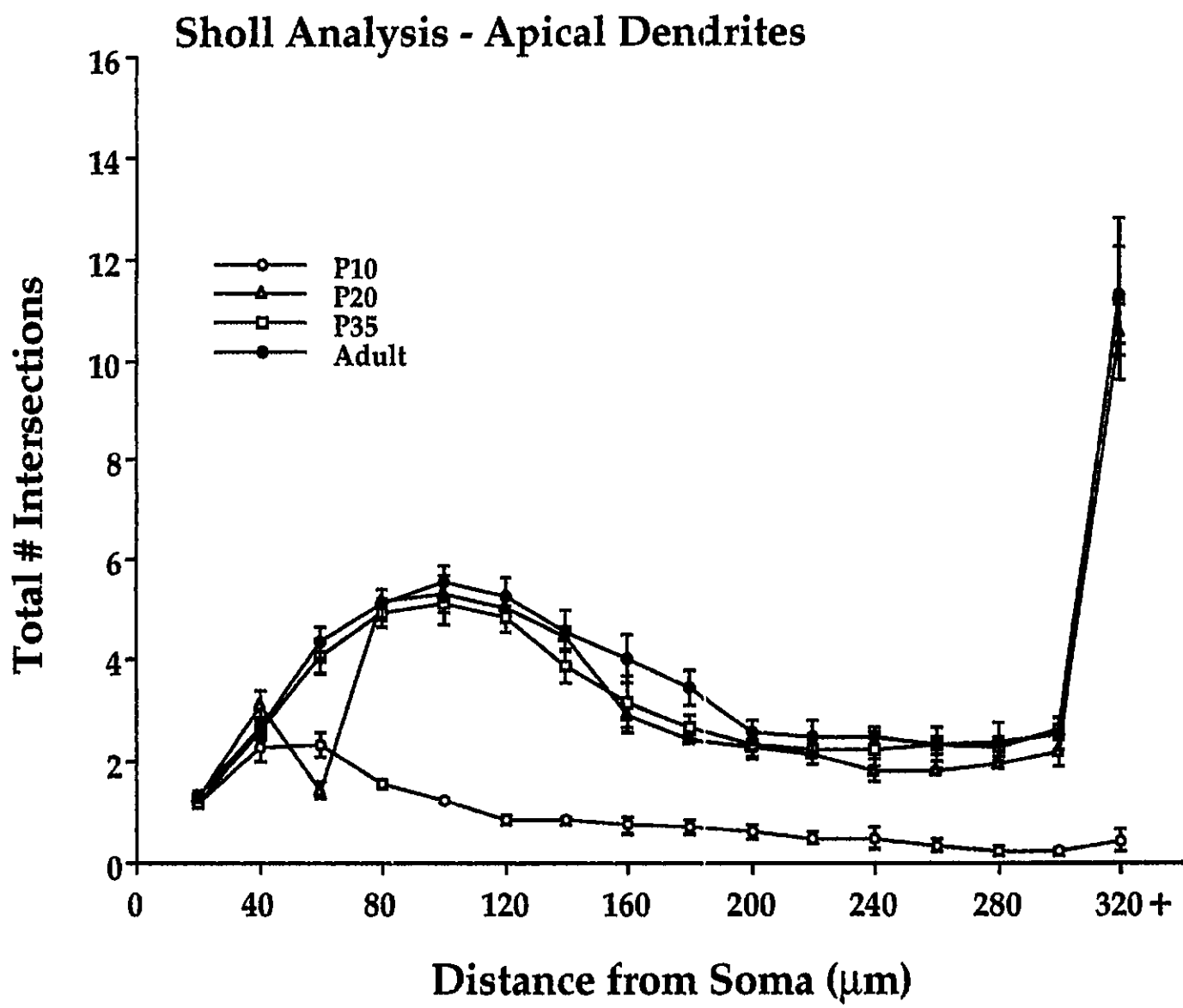
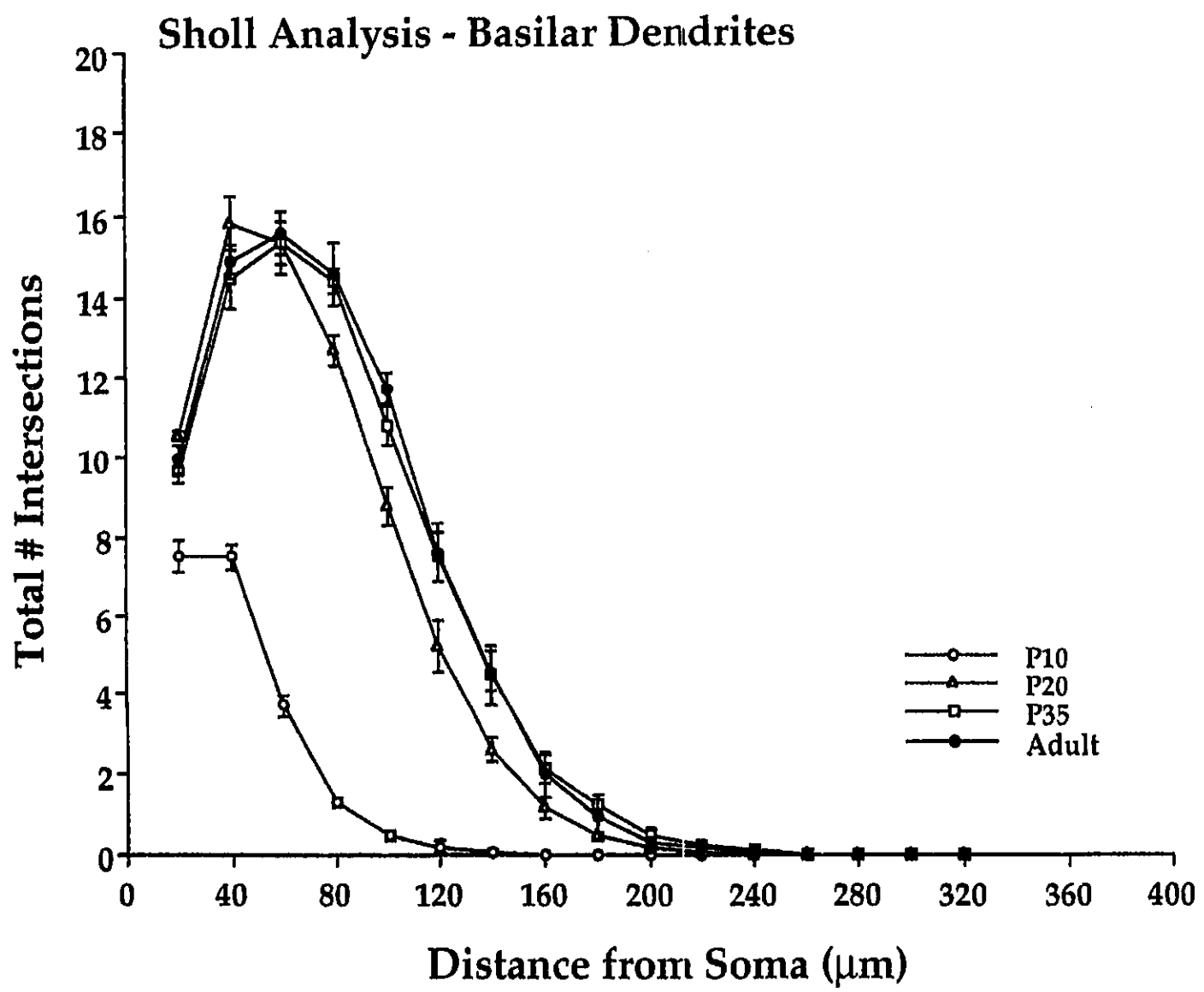

Figure 25A. Sholl analysis of apical dendrites on Layer III Pyramidal neurons in the FL area of motor cortex.



**Figure 25B.** Sholl analysis of basilar dendrites on Layer III Pyramidal neurons in the FL area of motor cortex.

significant age difference in both the apical dendrites ( $F(3,2552)=177.30$ ,  $P<0.0001$ ) and the basilar dendritic trees ( $F(3,2552)=66.95$ ,  $P<0.0001$ ). There is a significant hemispheric difference found in the apical dendritic trees with the right hemisphere being larger ( $F(1,2552)=15.31$ ,  $P<0.0001$ ) (Fig.26).

#### *Branch Order Analysis*

No hemisphere differences in apical or basilar dendritic trees were found so the data from each hemisphere was collapsed for the analysis. The Layer III pyramidal neurons were mature by P20, as was found using the Sholl analysis. The apical dendrites at P10 were very few, but by P20 were in a mature state ( $F(3,184)=177.30$ ,  $P<0.0001$ ). The basilar dendrites were branching out at P10, but only at low branch order numbers ( $F(3,184)=66.85$ ,  $P<0.0001$ ).

The Layer III pyramidal neurons appeared to be morphologically mature by P20 (Fig. 27), which parallels the maturation of Layer V pyramidal neurons (Petit, et al, 1988). At P10 there are very few dendrites found on the Layer III pyramidal neurons which implies that they most likely have not made proper connections with their targets at this age. The amount of dendritic branching increases significantly by P20 and takes on an adult-like appearance which is not significantly different from P100 rats. The P35 and adult pyramidal neurons do appear to have more processes associated with them, but is only qualitatively different from the P10 neurons.

The present Sholl analysis data shows that the apical dendrites in P10 rats do not have many bifurcations past the primary dendrite, but P20 and older rats show the same number of bifurcations radiating out from the

## Layer III Pyramidal Cells

93

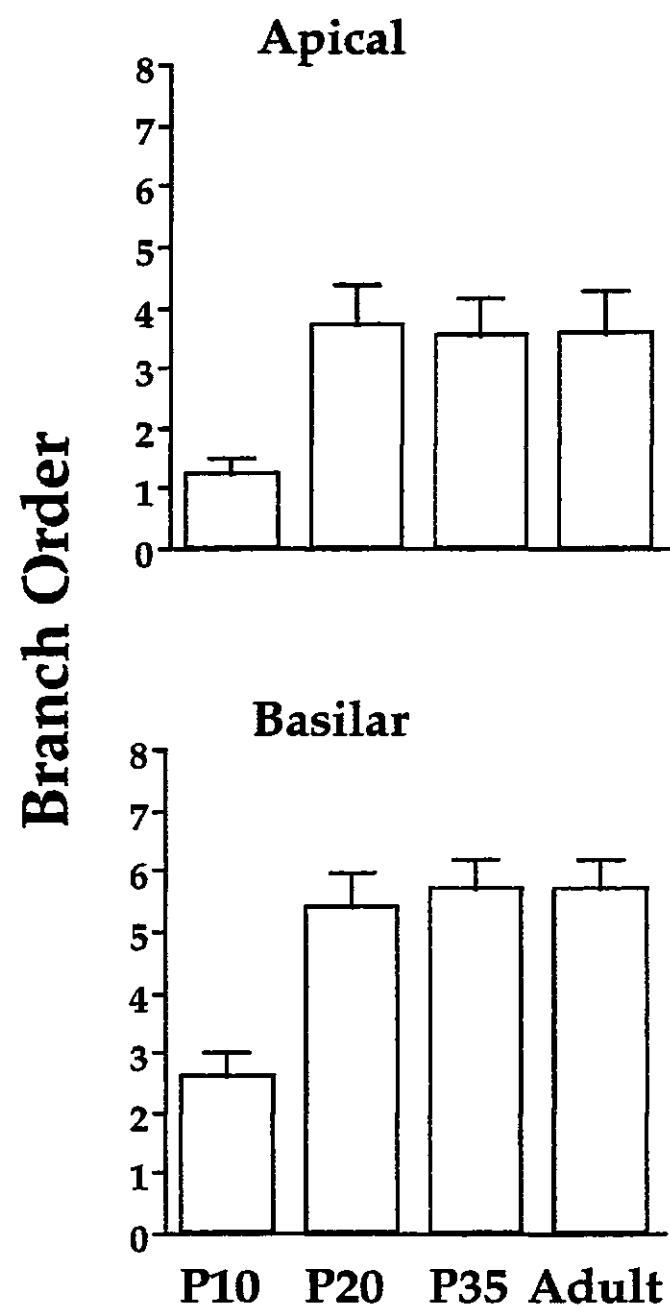

**Figure 26.** Golgi-Cox impregnated Layer III pyramidal neurons subjected to Branch Order Analysis at four ages.

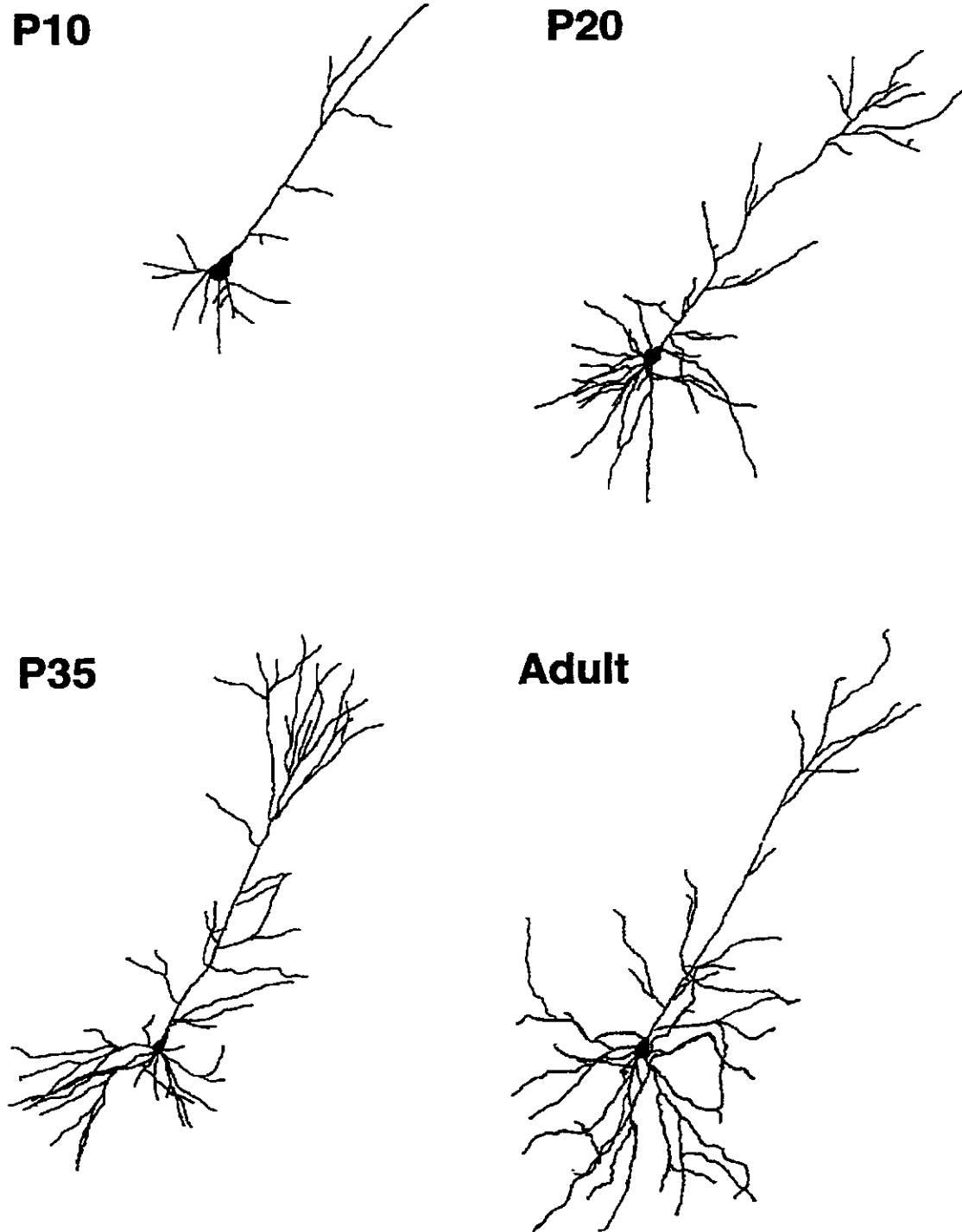

**Figure 27.** Camera Lucida drawings of Layer III pyramidal cells impregnated with Golgi-Cox. Taken from Zilles' FL area of the sensorimotor cortex.

primary dendrite. The basilar data for P10 show that they have very few bifurcations coming out from the soma, but the P20 data demonstrates a difference from the mature animals. The P20 animals have the same pattern of branching, but have less intersections in the 80 to 140  $\mu\text{m}$  range according to Sholl analysis. Branch order analysis shows that the P10 pyramidal neurons are in an immature state, but by P20 they have taken on the mature morphology.

It is possible that the neurons at P20 are not in a mature state, but with the analysis that was used, they meet the criteria for adult morphology. Dendritic length or spine density may indicate that the adult layer III neurons are larger, but for this study they are considered morphologically mature.

### III. Astrocytes

The developmental surface density pattern of GFAP immunoreactivity showed different results depending upon the layer examined (Fig. 28). No differences between hemispheres were found. There was a significant age difference found in both superficial ( $F(5,90)=28.15$ ,  $P<0.0001$ ) and deep layers ( $F(5,90)=8.67$ ,  $P<0.0001$ ) in the FL area of the cortex. Both layers showed a steady increase in stained processes up to P20, but deep layers show a decline by P25 while the superficial layers were still increasing in the number of positively stained processes. The deep layers show an adult pattern at P25, while the superficial layers drop off by P30 and then rise back up to adult values. A pictorial representation can be seen in figure 29.

Glial cell skeletons are made up of glial fibrillary acidic protein when

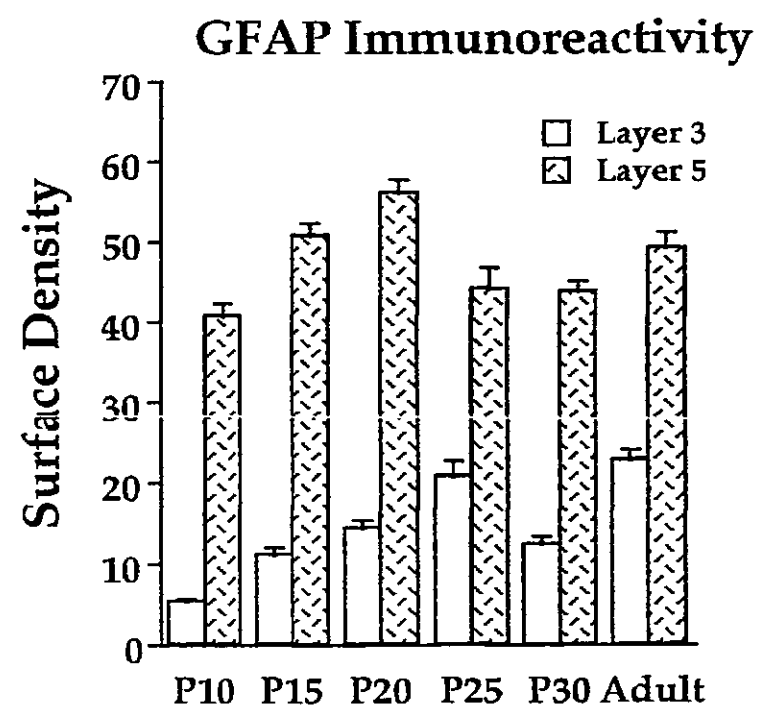

Figure 28. GFAP-immunoreactivity through development.



## GFAP Immunoreactivity

97

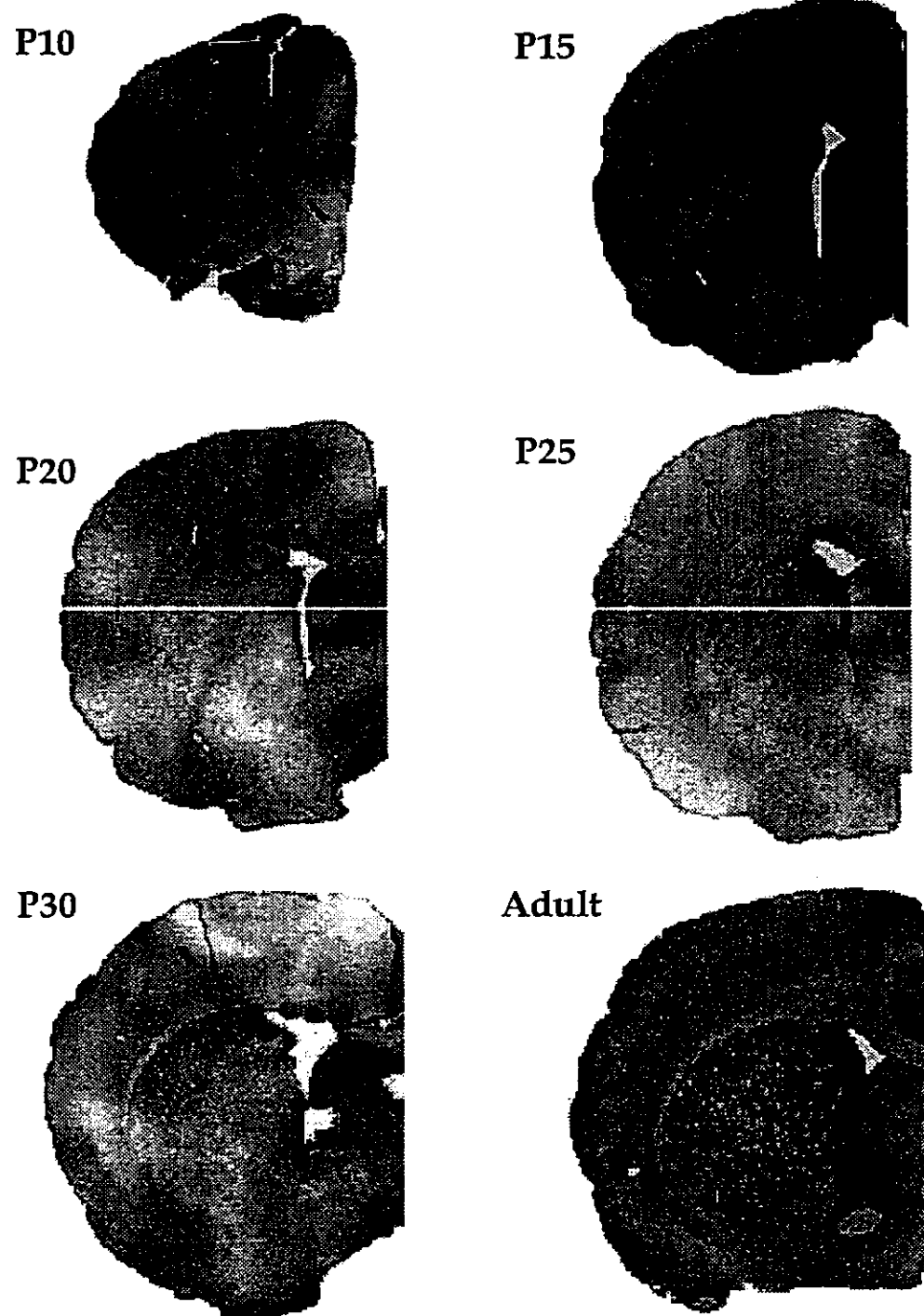

Figure 29. Development of GFAP immunoreactivity in the FL Area using Schmued's Gold Chloride Stain. A) P10, B) P15, C) P20, D) P25, E) P30, F) Adult.

they become mature (Dahl, 1981 and Parnavelas, et al, 1983). The results of the present study show that there is a peak in expression of GFAP-immunoreactive processes from P20 until P25. This overall peak expression is due to the superficial and deep layers having differing peaks in positively-stained astrocytic processes, deep layers peak at P20 but superficial layers do not peak until P25. The deep layers reduce the amount of expression by adulthood, but the superficial layers have a drop in expression at P30 and come back up to mature levels by adulthood. According to Stichel, Müller and Zilles (1991) adult-like GFAP staining in the visual cortex in deep and superficial layers are not achieved until around P50. They also reported that in adulthood that Layers III and V are GFAP poor which agrees with the results in this study that show that in the FL area the deep layer expression of GFAP decreases into adulthood but in contrast, the findings here show that in the superficial layers there is an increase of expression into adulthood.

#### **IV. Myelination**

In a pictorial representation of the staining intensity of the myelin stain a dramatic difference across ages is seen (Fig. 30). Therefore, relative density measurements of the FL area of the cortex was used as a measure of the proliferation and maturity of myelination of axonal processes within the cortex. At P10 very little staining was seen, but the intensity increased in both superficial and deep layers until adult-like myelination was achieved in the deep layers by P20 in both hemispheres, with an overall hemispheric difference with the left hemisphere showing greater

# Myelin Staining

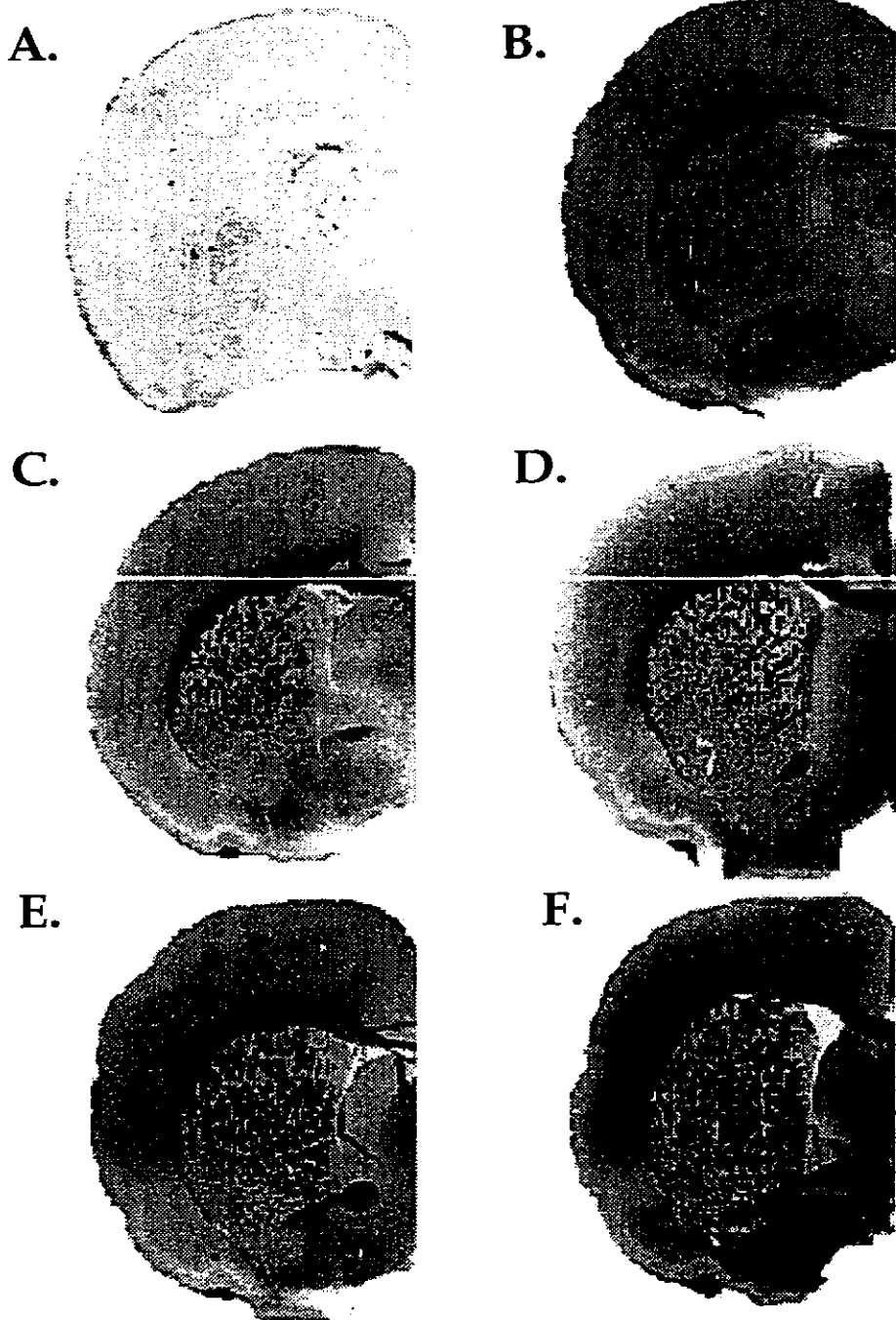

**Figure 30.** Development of myelin in the FL Area using Schmued's Gold Chloride Stain. A) P10, B) P15, C) P20, D) P25, E) P30, F) Adult.

density of myelination (Left hemisphere:  $F(5,36)=86.87$ ,  $P<0.0001$ ; Right hemisphere:  $F(5,36)=81.31$ ,  $P<0.0001$ ). Superficial layers, however, do not show adult-like myelination until P30 with a greater intensity of myelination also being found in the left hemisphere (Left hemisphere:  $F(5,36)=48.45$ ,  $P<0.0001$ , Right hemisphere:  $F(5,36)=29.83$ ,  $P<0.0001$ ). An overall sex difference was also seen in the deep layers of both hemispheres (Left hemisphere:  $F(1,84)=5.89$ ,  $P=0.02$ , Right hemisphere:  $F(1,84)=6.76$ ,  $P=0.01$ ), but only in the superficial layer of the left hemisphere ( $F(1,84)=5.20$ ,  $P=0.03$ ) (Fig. 31).

Myelination of the FL area of the motor cortex began after P10. Each hemisphere and layer had different myelination profiles. The left hemisphere had a higher density of myelinated fibres in both the deep and superficial layers than that of the right hemisphere, which may be due to the volumetric difference in cortical thickness that is shown by the Nissl body stain in part I. The superficial layers show a mature profile by P20, the males show a more gradual increase up to mature levels whereas the females appear to spike up to mature levels and level off. In the deeper layers the same sex difference profile is seen, but females have a greater density of myelinated fibres than males. The sex differences indicate that the females have a greater density of myelin in the FL area of the motor cortex. This difference may be indicative of a larger cell density found within the female's cortex which may lead to more axonal processes.

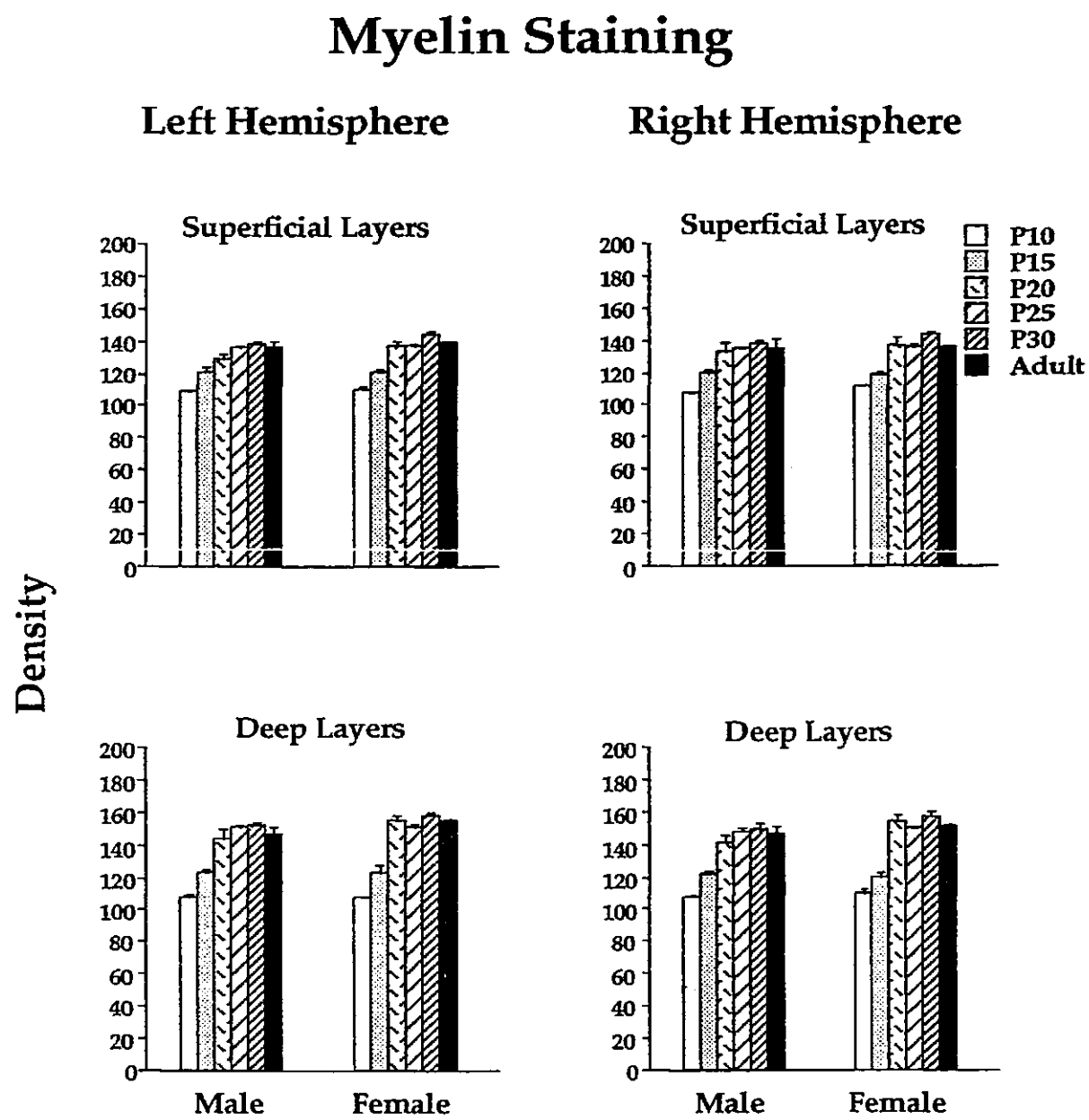

**Figure 31.** Myelin density measures through development. These graphs demonstrate the development of myelination in the forelimb cortex of male and female rats, in the superficial and deep layers of the two hemispheres.

#### V. c-fos-immunoreactivity

There was a significant age difference found across development in c-fos immunoreactivity ( $F(5,186)=66.58$ ,  $P<0.0001$ ). The data show a steady increase from P10 until P20/P25, from whence it plateaus until it drops down to a lower level by adulthood (Fig. 32). There were no differences found across hemispheres, layers or sexes. Figure 33 gives a pictorial representation of the intensity of staining of c-fos-immunoreactivity across development. The expression of c-fos-immunoreactivity is transient. There is a gradual increase in immunoreactivity up until P25 after which expression plateaus from P25 until P30, and drops down to a lower level of expression in adulthood. This peak in expression of c-fos may indicate that there is greater activity in the FL area, which could be due to the neurons and glial cells showing more activity. c-fos can be turned on by a number of events including calcium influx associated with cell to cell communication or the random firing of the neurons. The maturation of the stimulation-transcription coupling mechanism has been suspected to be the reason behind differential expression of c-fos through development (Herrera, Figueiredo & Cuello, 1993). The neurons are not morphologically mature until P20 in the rat which parallels the first initial spike in c-fos expression, the glial cells are not mature until P25/P30 which is where the expression of c-fos plateaus. This data is correlational, but the expression of c-fos may indicate the development of the brain cells becoming morphologically and functionally mature in the FL area of the motor cortex. There is evidence that AP-1 binding activities are involved in plasticity of the cerebral cortex in

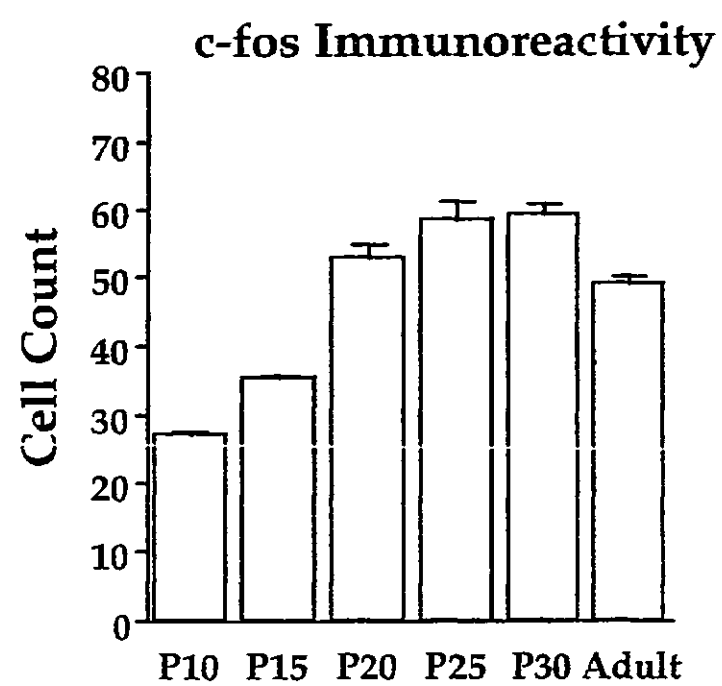

**Figure 32.** Developmental expression of c-fos immunoreactivity in the forelimb cortex.

## c-fos immunoreactivity

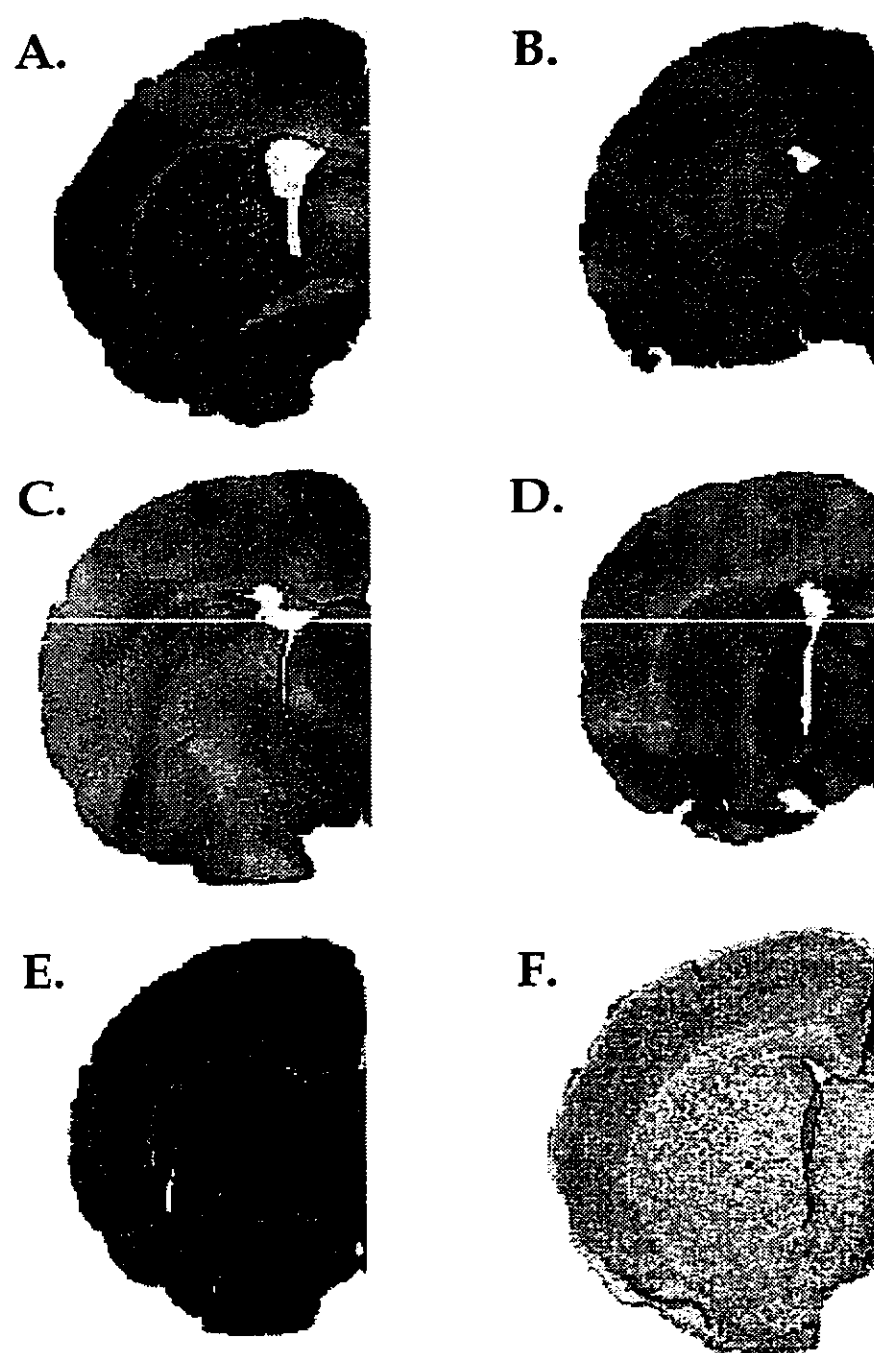

**Figure 33.** Development of Fos-immunoreactivity in the FL Area of the cortex. A) P10, B) P15, C) P20, D) P25, E) P30, F) Adult.



development and in cortical injury responses (Kaminska, et al, 1995). c-fos is part of a heterodimer with c-jun which binds to this AP-1 binding site and acts as a transcription factor which may lead to plastic responses in the central nervous system.

#### VI. Acetylcholinesterase

Acetylcholinesterase (AChE) activity is initially very high in P10 and P15 rats, but decreases by P20 and shows a steady increase in activity until adulthood (Fig. 34). There was an overall significant difference across ages in both hemispheres (Left:  $F(5,84)=85.36$ ,  $P<0.0001$ ; Right:  $F(5,84)=84.82$ ,  $P<0.0001$ ). A sex difference was found in the right hemisphere ( $F(1,84)=6.688$ ,  $P=0.01$ ) and there was a sex by age interaction found in both hemispheres (Left:  $F(5,84)=5.27$ ,  $P=0.0003$ ; Right:  $F(5,84)=7.10$ ,  $P<0.0001$ ). The sexes show a different developmental profile of AChE activity with females plateauing at adult like levels by P25 and males not reaching maturity until adulthood (Fig. 35).

There appears to be a spike in AChE density in P10 and P15 rats which then drops off to a low level and slowly climbs back up to mature levels. The stained processes at P10 and P15 do not appear morphologically mature at a qualitative level, but no measurements were done to check the functional maturity of the ACh system. This temporary increase in AChE levels may be a true phenomenon due to the same type of peak intensity being seen in the developing thalamocortical systems where Robertson and colleagues (1988) documented that AChE first appears at P6 and peaks at P10-12 and then

# Acetylcholinesterase

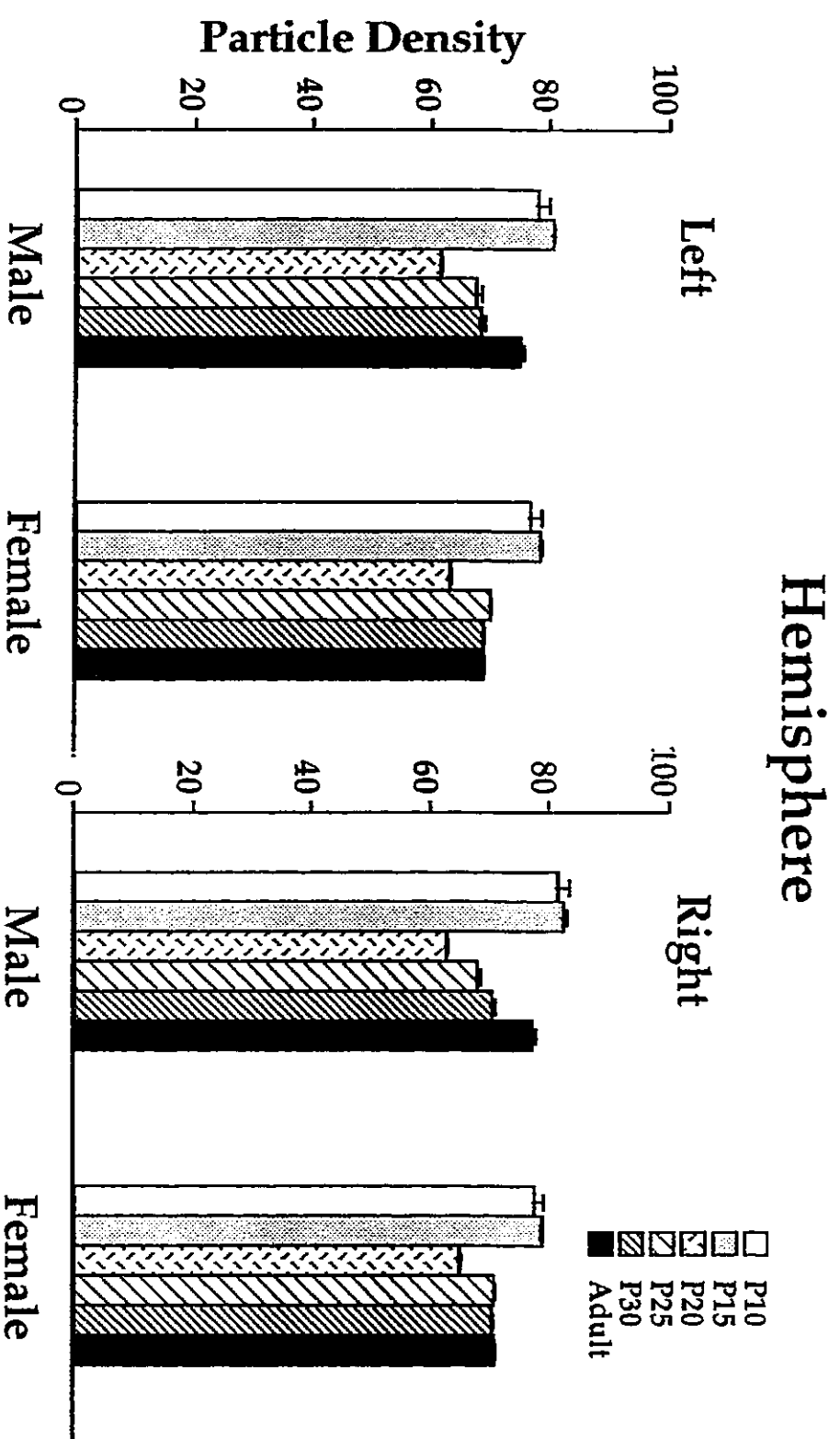
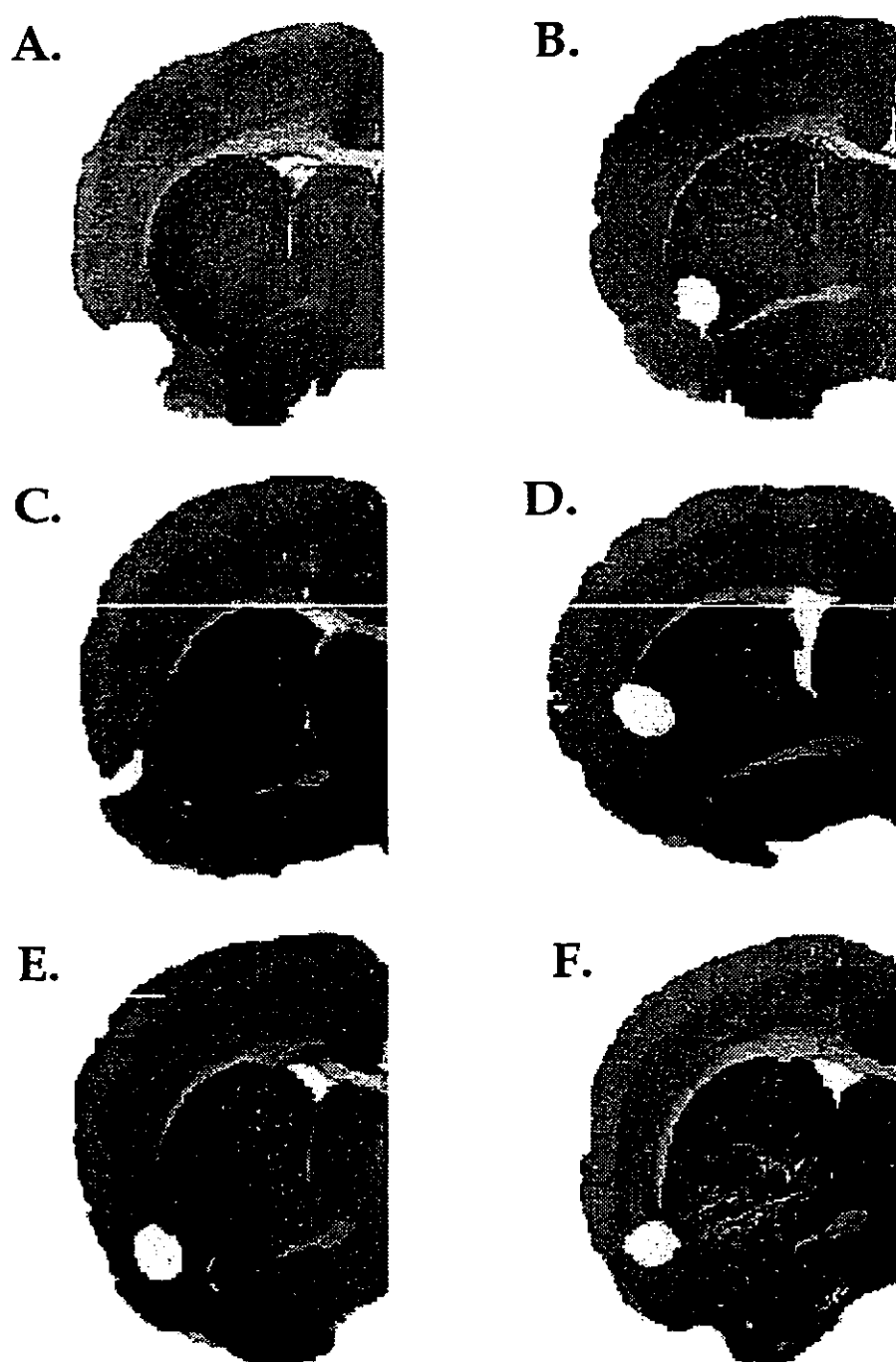

Figure 34. AChE expression during development in both left and right hemispheres.

## AChE Staining



**Figure 35.** Development of AChE activity in the FL Area. A) P10, B) P15, C) P20, D) P25, E) P30, F) Adult.

declines to adult levels by P21. Kostovic and Goldman-Rakic (1983) suggest that the transient increase seen in AChE levels may occur during the time that thalamocortical axons are growing towards their cortical targets. To further strengthen this opinion, Kristt and Waldmann (1981) show that lesioning the ventrobasal complex, the cortical target, that a marked decrease in AChE staining was noted in the developing rat.

Male and female rats show different developmental profiles of AChE activity with the males attaining higher levels into adulthood than the females. The males show a gradual increase that is significantly different right into maturity, but the females spike up to adult levels by P25. This sex difference indicates that the female ACh system may be mature much earlier than males.

#### CONCLUSION

The present studies analyzed the development of the anatomy and biochemistry of the forelimb area of the motor cortex and a summary of the main findings is shown in Figure 36. The cortex has reached mature thickness by P20 with a volumetric difference being found between the hemispheres, with the left hemisphere found to be consistently larger than the right. This result parallels that of the morphological maturity of pyramidal neurons found in layer III and the myelination of both superficial and deep layers of the cortex. The possibility exists that cortical thickness is dependent upon the maturation of the dendritic processes of the pyramidal neurons, since both the layer III and layer V pyramidal neurons appear to

## Maturity or Peak Expression

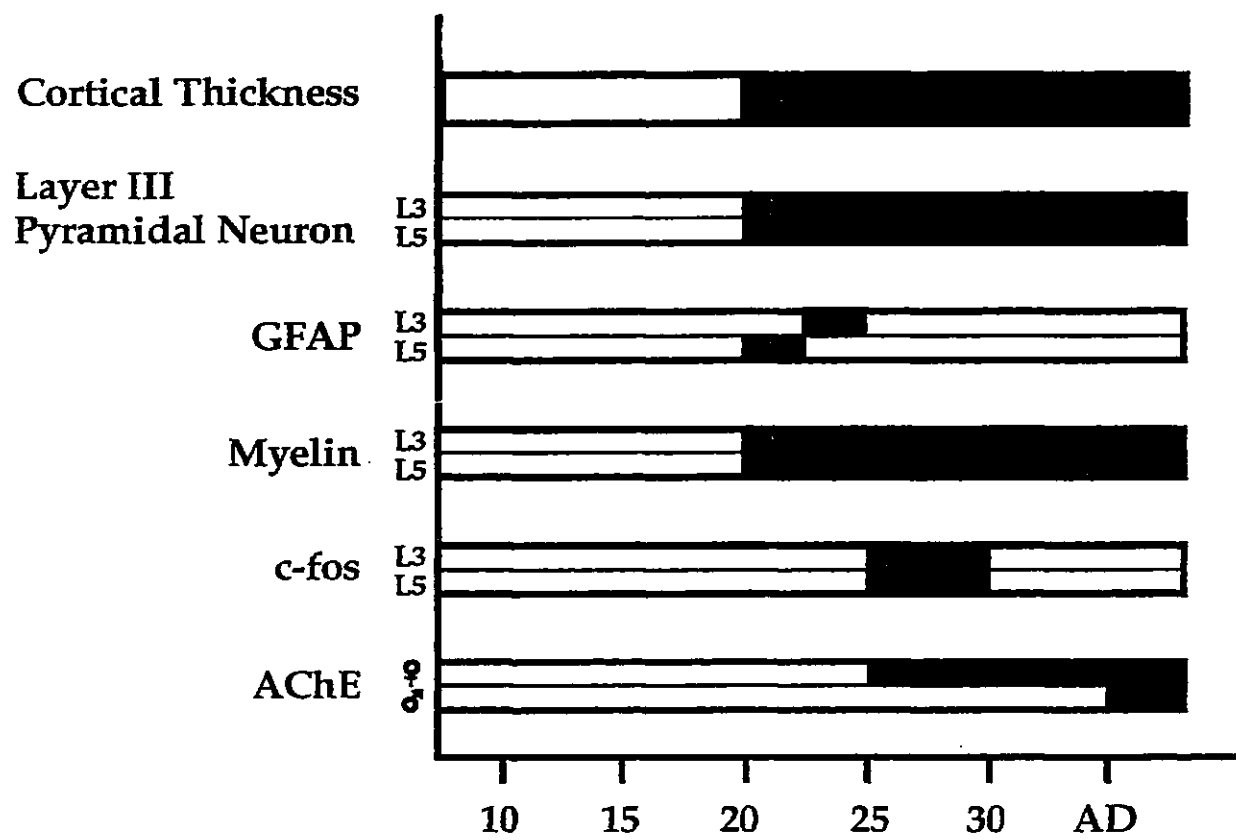

**Figure 36.** Peak or mature expression of biochemical markers during development. Black bars show either the peak or mature expression of the marker.

mature at the same time (Petit, et al, 1988).

Glial cells are important in the maintenance and repair of the brain. When these cells are in a mature state, glial fibrillary acidic protein is found within their intermediate filaments. The forelimb area of the cortex shows an over proliferation of these cells during development, with a difference between superficial and deep layers. There is a peak in GFAP-immunoreactivity seen in deep layers around P25, but in superficial layers the peak occurs around P30, which decreases to mature levels. This suggests that the deep layers are maturing at a faster rate than the superficial layers, which is in agreement with the neurogenetic hypothesis' inside-out pattern of development. It has been hypothesized that neuronal and glial cells interact with one another and that they may be involved in the differentiation and growth of one another. Since the neurons were morphologically mature by P20, they may be involved in the over proliferation of astrocytes. The glial cells on the other hand may be causing the dendritic arbor to grow on the pyramidal neurons since there is a GFAP-immunoreactive activity spike around P25 to P30.

Oligodendrocytes are another type of astrocyte which act to form the myelination of the axons. Myelination does not occur until P12 (Kandel, Schwartz & Jessell, 1991), which is noticeable in the staining of the P10 brains where very little staining is seen in the brain section. The density of the myelin does reach adult-like levels by P20 which also parallels the maturity of the cortical thickness and morphology of layer III pyramidal neurons. It has been suggested that pyramidal neurons start extending their axonal process to

their target structures before they have reached their final destination (Bayer & Altman, 1991). This suggests that the axons may be available to be myelinated before dendritic processes have formed their connections with neighbour cells.

The immediate early gene *c-fos* is expressed transiently during development. This peak in Fos-immunoreactivity may be indicative of greater activity in the FL area around P25, which may be due to the neurons and glial cells showing more activity or just becoming functionally active. *c-fos* is expressed when a cell is activated either when communication from another cell or through chemical stimuli such as hormones. The cells may be morphologically mature at P20, but they may not be functionally active until after this age.

Acetylcholinesterase activity shows a gradual increase in staining intensity from P10 to P30 where it is indistinguishable from the adult rat. The changes seen in acetylcholinesterase staining may be indicative of a transient flux of AChE that appears around P10 to P15 in rats, which disappears and then reappears in the mature form around P30. Acetylcholine plays a modulatory role in the cerebral cortex which may explain why the AChE system does not show a mature pattern until P30. The neurons and glial cells have reached their adult-like morphology.

The biochemical markers used in this thesis show that the forelimb area of the motor cortex may be anatomically and biochemically mature by P30 in the female rat, but not the male rat.

#### Chapter 4: General Discussion

The aim of this thesis was to examine the relationship between a number of complex behaviours used to acquire, protect, and consume food and changes in a number of biochemical and anatomical features of the motor cortex, a structure that may participate in the mediation of these behaviours (Whishaw & Gorny, 1994; Whishaw & Coles, 1996). Whereas some of the behaviors that were examined matured rather rapidly, suggesting subcortical mediation, others matured much more slowly over a longer time period, suggesting that these behaviours may be mediated by the developmentally younger cortical areas. When the behavioural markers and developmental markers were juxtaposed, there appeared to be a close relationship between them, such that morphological and biochemical maturation was taking place just prior to or concurrent with the emergence of behaviour. These results may have a bearing on a number of developmental questions, including the extent to which complex behaviour is structurally versus environmentally determined and the extent to which experience contributes to adult complexity.

The behavioural study demonstrated that during development some behaviours mature very quickly while others mature more slowly. For example, the eyes opened by P16 and within one day the pups were eating hard food pellets, while behaviours such as reaching and bimanual coordination appeared to mature over a period of two weeks or more. There are at least three reasons for the differences present in developmental speed. First, it is arguable that certain behaviours are the foundation upon which



many other behaviours depend, and these behaviors must develop rapidly. For example, it is essential that a rat must quickly acquire the ability to eat, which once attained can then be supported by complex food gathering activities, such as stealing food from conspecifics. Second, it is likely that other behaviours are interdependent, and so being more complex, require a longer time to mature. For example, in order to use skilled forepaw movements an animal must be able to sit up and balance on its hind legs. Golani and Fentress (1985) describe a similar relationship between limb use and balance during the development of grooming. The limb movements of grooming actually develop before posture but can only be used effectively once posture is mature. Third, some behaviours likely require a learning component and so may be variable in development because they depend upon opportunity. Dodging may be such an example, an animal has no need to dodge to protect its food unless a conspecific attempts a theft. In addition, the victim likely has to learn to calibrate its dodges to most effectively protect its food. This is supported by the behavioural experiment in that the emergence of dodging behaviour follows the emergence robbing attempts. As the rats mature, the robbing pattern begins to change, and it appears that the dodging behaviour is modified parallel or subsequent to these behavioural changes.

In suggesting these potential relationships between behavioural maturation and function, a number of weaknesses in the present behavioural analysis must be noted. The objective of the behavioural study was to determine the onset of behaviours and a detailed qualitative analysis fell

beyond the scope of this objective. Thus, no attempt was made to determine the extent to which certain behaviours were interdependent, nor was an attempt made to determine what role opportunity, experience, and learning play in behavioral maturation. Such analyses would require more extensive videorecording, a more restricted focus on certain target behaviours, and considerable manipulation of the experimental situation. Nevertheless, despite the restricted focus of the present analysis, it does highlight significant insights into behavioural and brain maturation.

Just as with behaviour, the anatomical and biochemical assay of the developing forelimb cortex showed that some structural and biochemical markers matured quickly while others developed over a long period of time. For example, the pyramidal neurons found in layer III were mature by P20, while acetylcholinesterase activity appeared to be still maturing into adulthood.

The differences in the rate of maturation of various features of the forelimb cortex may occur for a number of reasons. First, it may be that in order for certain events to occur there must be a pre-existing foundation. For example, before cholinergic synapses can contact a neuron the neuron and its dendritic field must be relatively mature. Therefore, cholinergic projections cannot target cortical cells until those cells are mature, and thus the marker for acetylcholinesterase, the enzyme that degrades acetylcholine, will not be found until quite late in development. Second, some structures are likely interdependent and it is possible that their connections will not be formed until they themselves are mature. Additionally, neurons and glia have been

shown to mutually influence one another (Shao & McCarthy, 1994), therefore the peak in GFAP-immunoreactivity at P25 to P30 may be due to the pyramidal neurons releasing some type of growth factor which influences the proliferation of astrocytes. Astrocytes are also involved in the maintenance and repair of the neurons, the peak expression may be demonstrating an overproliferation of cells followed by cell death, like that seen in neuronal proliferation, to prune back astrocytes that are not needed. Third, there may be influences on structural maturation that derive from other sources, such as hormones. For example, the acetylcholinesterase density in female rats reaches adult levels by P30, but in male rats this event does not occur until after this time. The levels at P30 are comparable to one another, which may explain why no differences are seen in the behavioural outputs.

It is important to note that the use of the neurochemical and anatomical markers was opportunistic, relying on the use of well developed techniques. It is unquestionably the case that there are many changes taking place in the developing cortex that could not be examined. Tract-tracing methods may have been used to determine when neurons have extended their axons to contact other cells in other brain areas, and between hemispheres. A more detailed analysis of the neurochemistry of the cortex may have been done using techniques like microdialysis to measure extracellular concentrations and turnover in neurotransmitters throughout development, which may given insights into the development of many transmitter systems (Lazarewicz, et al, 1995). Thus, the development of other cortical areas and the extent to which other biochemical markers, or other

chemical events, such as hormonal fluctuations, have an influence on the growth and maturation of the forelimb area were not investigated. Even though this study was restricted to a small number of techniques, and only a few of the many markers of cortical maturity were chosen, it does provide insights into the pattern of development of the forelimb motor cortex.

Any attempt to link the behavioral and anatomical changes in a causal way would not be justified when using a correlational study. Nevertheless, when the behavioural and developmental markers are plotted against one another, they appear to indicate an intimate association such that maturation of the forelimb area preceded or paralleled behavioural development (Fig. 37). Before any of the behaviours showed adult characteristics, the forelimb area showed maturation of cortical thickness. The onset of robbing behaviour and maturation of carry-to-eat behaviour was concurrent with maturation of neuronal morphology and myelination of axons. Reaching behaviour emerges following the maturation of these structures and becomes mature simultaneously with the onset of peak expression of GFAP-immunoreactivity at P25, and precision reaching attains mature form just after the astrocytes have dropped down to adult-levels. Dodging behaviour becomes mature at the onset of peak expression of Fos-immunoreactivity and bimanual coordination while eating pasta is mature subsequently at P30 at about the time that cholinesterase markers are maturing.

## Maturation in *Rattus norvegicus*

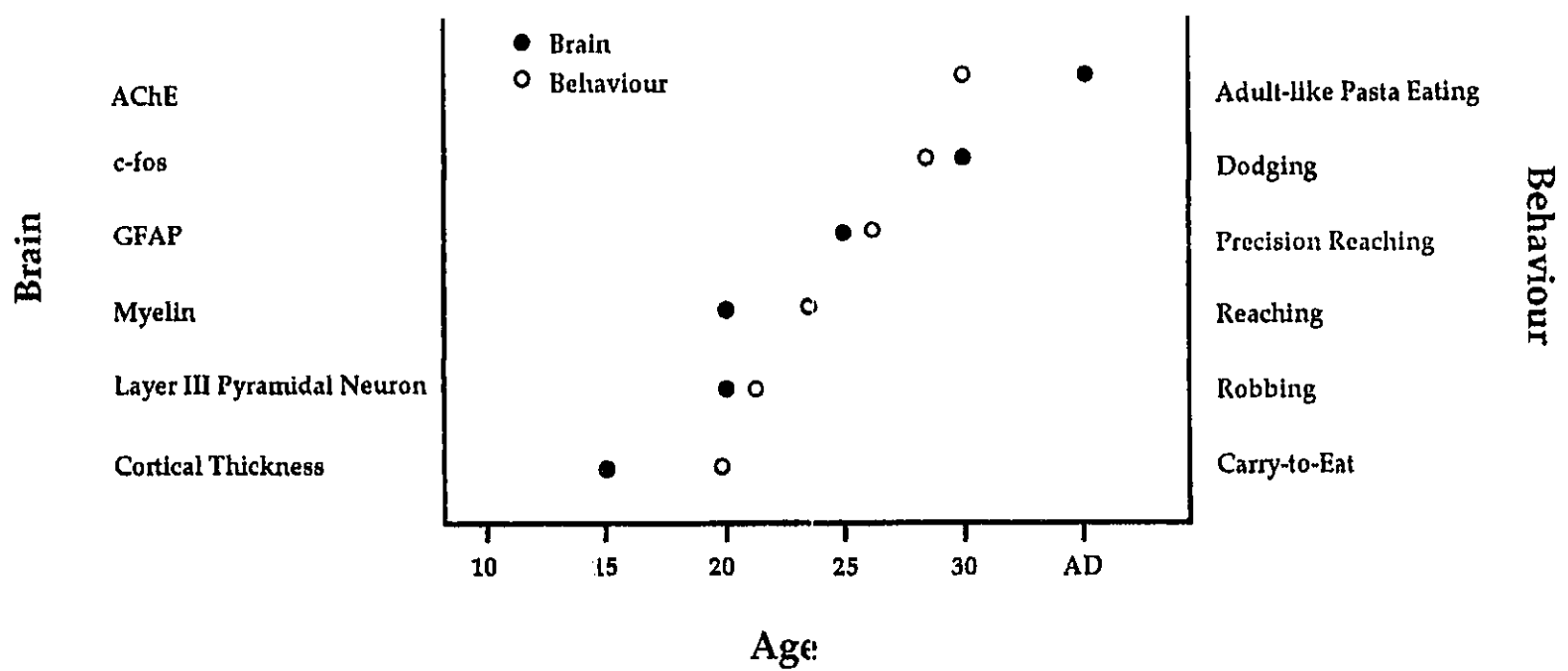

Figure 37. Graphic illustration between maturation of the FL area of the motor cortex and development of complex motor behaviours. Solid circles represent the maturity of the forelimb area of the motor cortex and the open circles represent when specific behaviours become mature.

It is interesting that when the pattern of behavioral maturation is considered, it appears to follow a gradient from simple acts such as chewing and eye opening, to more complex acts such as walking and rearing, which require postural support mechanisms, to skilled movements, which require not only adjustments of parts of the limbs but also the participation of appropriate postural adjustments. Anatomically, the pattern of inside out maturation described by Bayer and Altman (1991) appears to continue into adolescence such that the deeper layers of the cortex and their associated markers are well developed earlier than the more superficial layers and their markers. These gradations suggest that more complex movements, requiring the integration of posture are accordingly more dependent upon the maturation of the superficial layers of the cortex than on the deeper layers. The pyramidal neurons of layers V project to the spinal cord where they participate in producing movements. The later maturation of the superficial layers may contribute the complexity of movement produced by the deeper layers. The layer III neurons also primarily send their axonal projects through the corpus callosum to the opposite hemisphere, which is important for the integration of movements that require bimanual coordination.

This thesis suggests that complex motor behaviours and forelimb cortex maturation may be related. The emergence and development of some behaviours appears to follow parallel or subsequent to the maturation of the forelimb cortex. There is a possibility that the behavioural maturation of motor behaviours requiring complex forelimb movements requires that the forelimb motor cortex be functionally mature. Another possibility that can

not be ignored is that other cortical structures are also developing and may also be responsible for the mediation of these behaviours. The delay seen in behavioural development after cortical maturation could possibly be explained by environmental or learning factors. To understand how much of an influence these extraneous variables have on the maturation of complex behaviours, further analysis must be done.

### References

- Alcantara, A. A. & Greenough, W. T. (1993). Developmental regulation of Fos and Fos-related antigens in cerebral cortex, striatum, hippocampus and cerebellum of the rat. *The Journal of Comparative Neurology*, 334: 75-85.
- Altman, J. & Sudarshan, K. (1975). Postnatal development of locomotion in the laboratory rat. *Animal Behaviour*, 23: 896 - 920.
- Bâ, A. & Seri, B. V. (1995). Psychomotor functions in developing rats: Ontogenetic approach to structure-function relationships. *Neuroscience and Biobehavioral Reviews*, 19(3): 413 - 425.
- Banker, G. A. (1980). Trophic interactions between astroglia cells and hippocampal neurons in culture. *Science*, 209: 809 - 810.
- Barres, B. A. & Raff, M. C. (1993). Proliferation of oligodendrocyte precursor cells depends on electrical activity in axons. *Nature*, 361: 258-260.
- Bayer, S. A. & Altman J. (1987). Directions in neurogenetic gradients and patterns of anatomical connections in the telencephalon. *Progress in Neurobiology*, 29: 57 - 106.
- Bayer, S. A. & Altman, J. (1991). Neocortical development. Raven Press, New York.
- Bohmann, D., Bos, T. J., Admon, A., Nishimura, T., Vogt, P. K. and Tijian, R. (1987). Human proto-oncogene *c-jun* encodes a DNA binding protein with structural and functional properties of transcription factor AP-1. *Science*, 238: 1386-1392.
- Bolles, R. C. & Woods, P. J. (1964). The ontogeny of behaviour in the albino



- rat. *Animal Behaviour*, 12(4): 427 - 441.
- Castro-Alamancos, M. A. & Borrell, J. (1993). Reversal of paw preference after ablation of the preferred forelimb primary motor cortex representation of the rat depends on the size of the forelimb representation. *Neuroscience*, 52(3): 637 - 644.
- Chamak, B.; Fellous, A; Glowinski, J. & Prochiantz, A. (1987). MAP2 expression and neuritic outgrowth and branching are co-regulated through region specific neuro-astroglial interactions. *Journal of Neuroscience*, 7: 3163-3170.
- Coleman, P. D. & Reisen, A. H. (1968). Environmental effects on cortical dendritic fields. I. Rearing in the dark, *J. Anatomy.*, 102: 363- 374.
- Curran, T. & Franza Jr., B. R. (1988). Fos and Jun: The AP-1 connection. *Cell*, 55: 395-397.
- Dahl, D. (1981). The vimentin-GFA protein transition in rat neuroglia cytoskeleton occurs at the time of myelination. *Journal of Neuroscience Research*, 6: 741 - 748.
- Diamond, M. C., Johnson, R. E., and Elhert, J. (1981). Age-related morphological cerebral cortical asymmetry in male and female rats. *Experimental Neurology*, 71: 261-268.
- Diamond, M. C. (1987). Sex differences in the rat forebrain. *Brain Research Reviews*, 12: 235 - 240.
- Distel, R. J. & Spiegelman, B. M. (1990). Protooncogene c-fos as a transcription factor. *Advances in Cancer Research*, 55: 37-55.
- Field, E. F.; Whishaw, I. Q. & Pellis, S. M. (1996). A kinematic analysis of

evasive dodging movements used during food protection in the rat (*Rattus norvegicus*): Evidence for sex differences in movement. *Journal of Comparative Psychology*, 110(3): (in press).

Garcia-Segura, L. M.; Chowen, J. A. & Naftolin F. (1996). Endocrine glia: Roles of glial cells in the brain actions of steroid and thyroid hormones and in the regulation of hormone secretion. *Frontiers in Neuroendocrinology*, 17: 180-211.

Gard, C.; Hård, E.; Larsson, K. & Petersson, V-A. (1967). The relationship between sensory stimulation and gross motor behaviour during the postnatal development in the rat. *Animal Behaviour*, 15: 563 - 567.

Georgiou, J.; Robitaille, R.; Trimble, W. S. & Charlton. (1994). Synaptic regulation of glial protein expression in vivo. *Neuron*, 12: 443-455.

Golani, I. & Fentress, J. C. (1985). Early ontogeny of face grooming in mice. *Developmental Psychobiology*, 18(6): 529 - 544.

Greenough, W. T.; Larson, J. R. & Withers, G. S. (1985). Effects of unilateral and bilateral training in a reaching task on dendritic branching of neurons in rat motor-sensory forelimb cortex. *Behavioral and Neural Biology*, 44: 301 - 314.

Hall, W. G. (1979). The ontogeny of feeding in rats: I. Ingestive and behavioral responses to oral infusions. *Journal of Comparative and Physiological Psychology*, 93(6): 977 - 1000.

Hall, W. G.; Cramer, C. P. & Blass, E. M. (1977). Ontogeny of suckling in rats. *Journal of Comparative and Physiological Psychology*, 91: 1141 -1155.

Hall, W. G. & Rosenblatt, J. S. (1977). Suckling behavior and intake control in

the developing rat pup. *Journal of Comparative and Physiological Psychology*, 91: 1232 - 1247.

- Hatten, M. E. (1990). Riding the glial monorail: A common mechanism for glial-guided neuronal migration in different regions of the developing mammalian brain. *Trends in Neuroscience*, 13: 179-184.
- Herrera, D. G., Figueiredo, B. F. & Cuello, A. C. (1993). Differential regulation of c-fos expression after cortical brain injury during development. *Developmental Brain Research*, 76: 79-85.
- Hyson, R. L. & Rudy, J. W. (1984). Ontogeny of learning: II. Variation in the rat's reflexive and learned responses to acoustic stimulation. *Developmental Psychobiology*, 17: 263 - 283.
- Ivanco, T. L.; Pellis, S. M. & Whishaw, I. Q. (1996). Skilled forelimb movements in prey catching and in reaching by rats (*Rattus norvegicus*) and opossums (*Monodelphis domestica*): Relations to anatomical differences in motor systems. *Behavioural Brain Research*, 79: 163 - 181.
- Jacobson, M. (1991). Developmental neurobiology 3rd. Ed. Plenum Press, New York.
- Kálmán, M. & Hajós, F. (1989). Distribution of glial fibrillary acidic protein (GFAP)-immunoreactive astrocytes in the rat brain: I. The forebrain. *Experimental Brain Research*, 78: 147 - 163.
- Kaminska, B.; Mosieniak, G.; Gierdalski, M.; Kossut, M. & Kaczmarek, L. (1995). Elevated AP-1 transcription factor DNA binding activity at the onset of functional plasticity during development of rat sensory cortical

areas. *Molecular Brain Research*, 33: 295-304.

Kandel, E. R.; Schwartz, J. H. & Jessell, T. M. (1991). Principles of Neural Science (3rd ed.). Elsevier, New York.

Kaur, C.; Ling, E. A. & Wong, W. C. (1989). Development of the various glial cell types in the cerebral cortex of postnatal rats. *Acta Anatomica*, 136: 204 - 210.

Kiss, J. & Patel, A. J. (1992). Development of the cholinergic fibres innervating the cerebral cortex of the rat. *International Journal of Developmental Neuroscience*, 10(2): 153-170.

Kolb, B. (1995). Brain plasticity and behavior. Lawrence Erlbaum Associates, Publishers, Mahwah, New Jersey.

Kolb, B. & Gibb, R. (1993). Possible anatomical basis of recovery of function after neonatal frontal lesions in rats, *Behavioral Neuroscience.*, 107:799-811.

Kolb, B. & Fantie, B. (1989). Development of the child's brain and behavior. In Handbook of clinical child neuropsychology. C. R. Reynolds & E. Fletcher-Janzen (eds). Plenum Publishing Corp., New York.

Kolb, B. & McLimans, J. (1986). A process for cryostat sectioning of Golgi-Cox tissue. *Stain Technology*, 61: 379-380.

Kolb, B. & Whishaw, I. Q. (1995). Fundamentals of Human Neuropsychology 4th Ed. W. H. Freeman and Company, New York.

Kostovic, I. & Goldman-Rakic, P. S. (1983). Transient cholinesterase staining in the mediodorsal nucleus of the thalamus and its connections in the developing human and monkey brain. *Journal of Comparative*

*Neurology*, 4: 25 - 42.

- Krisst, D. A. & Waldman, J. V. (1981). The origin of the acetylcholinesterase-rich afferents to layer IV of infant somatosensory cortex: A histochemical analysis following lesions. *Anatomical Embryology*, 163: 31 - 41.
- Krnjevic, K. (1988). Acetylcholine as transmitter in the cerebral cortex: In Neurotransmitters and Brain Function. M. Avoli, T. A. Reader, R. Dykes and P. Gloor, eds., Plenum Press, New York. pp 227-237.
- Krnjevic, K. & Silver, A. (1966). Acetylcholinesterase in the developing forebrain. *Journal of Anatomy*, 100(1): 63 - 89.
- Landry, C. F.; Ivy, G. O. & Brown, I. R. (1990). Developmental expression of glial fibrillary acidic protein mRNA in the rat brain analyzed by in situ hybridization. *Journal of Neuroscience Research*, 25: 194 - 203.
- Largo, C.; Cuevas, P. Somjen, G. G.; Martin del Rio, R. & Herreras, O. (1996). The effect of depressing glial function in rat brain *In Situ* on ion homeostasis, synaptic transmission, and neuron survival. *The Journal of Neuroscience*, 16(3): 1219 - 1229.
- Lawrence, D. G. & Kuypers, H. G. J. M. (1968). The functional organization of the motor system in the monkey. I. The effects of bilateral pyramidal lesions, *Brain*, 91: 1 - 14.
- Lazarewicz, J. W.; Puka-Sundvall, M.; Gadamski, R.; Sandberg, M. & Hagberg, H. (1995). Differential effects of n-methyl-d-aspartate on Ca<sup>2+</sup> homeostasis in developing and adult rat striatum: In vivo microdialysis approach. *International Journal of Developmental*

*Neuroscience*, 13(7): 695 - 704.

- Ling, E. A. & Leblond, C. P. (1973). Investigations of glia cells in semithin sections. II. Variations with age in the numbers of various glia types in rat cortex and corpus callosum. *Journal of Comparative Neurology*, 149: 73 - 82.
- Miura, M., Takayama, K. & Okada, J. (1994). Neuronal expression of Fos protein in the rat brain after baroreceptor stimulation. *Journal of the Autonomic Nervous System*, 50: 31-43.
- Moye, T. B. & Rudy, J. W. (1985). Ontogenesis of learning: VI. Learned and unlearned responses to visual stimulation in the infant hooded rat. *Developmental Psychobiology*, 18: 395 - 409.
- Murphy, T. H.; Blatter, L. A.; Wier, W. G. & Baraban, J. M. (1993). Rapid communication between neurons and astrocytes in primary cortical cultures. *Journal of Neuroscience*, 13: 2672-2679.
- Nicoll, A. and Blakemore, C. (1993). Patterns of local connectivity in the neocortex. *Neural Computation*, 5: 665-680.
- Parnavelas, J. G.; Luder, R.; Pollard, S. G.; Sullivan, K. & Lieberman, A. R. (1983). The development of non-pyramidal neurons in the visual cortex of the rat. *Anatomy and Embryology*, 155: 1- 14.
- Pellis, S. M. & Pellis, V. C. (1994). Development of righting when falling from a bipedal standing posture: Evidence for the dissociation of dynamic and static righting reflexes in rats. *Physiology & Behavior*, 56(4): 659 - 663.
- Pellis, V. C.; Pellis, S. M. & Teitelbaum, P. (1991). A descriptive analysis of the

postnatal development of contact-righting in rats (*Rattus norvegicus*).  
*Developmental Psychobiology*, 24(4): 237 - 263.

Peterson, G. M. (1934). Mechanisms of handedness in the rat. *Comparative Psychology Monographs*, 9(46): 1 - 67.

Peterson, G. M. & Barnett, P. E. (1961). The cortical destruction necessary to produce a transfer of a forced-practice function. *Journal of Comparative and Physiological Psychology*, 54: 382 - 385.

Peterson, G. M. & Devine, J. V. (1963). Transfers in handedness in the rat resulting from small cortical lesions after limited forced practice. *Journal of Comparative and Physiological Psychology*, 56: 752 - 756.

Peterson, G. M. & Fracarol, C. (1938). The relative influence of the locus and mass of destruction upon the control of handedness by the cerebral cortex. *Journal of Comparative Neurology*, 68: 173 - 190.

Peterson, G. M. & McGiboney, D. R. (1951). Reeducation of handedness in the rat following cerebral injuries. *Journal of Comparative and Physiological Psychology*, 44: 191 - 196.

Petit, T. L.; LeBoutillier, J. C.; Gregorio, A. & Libstug, H. (1988). The pattern of dendritic development in the cerebral cortex of the rat. *Developmental Brain Research*, 41: 209-219.

Pfaff, D. W. (1966). Morphological changes in the brains of adult male rats after neonatal castration. *Journal of Endocrinology*, 36: 415-416.

Porter, R. & Lemon, R. (1993). Corticospinal function & voluntary movement: Monographs of the Physiological Society. Clarendon Press, Oxford.

- Purves, D. & Lichtman, J. W. (1985). Principles of neural development. Sinauer Associates Inc. Publishers, Sunderland, Massachusetts.
- Rakic, P. (1981). Neuronal- glial interaction during development. *Trends in Neuroscience*, 7: 184 - 187.
- Rakic, P.; Cameron, R. S.; Komuro, H. (1994). Recognition, adhesion, transmembrane signalling and cell motility in guided neuronal migration. *Current Opinion in Neurobiology*, 4: 63-69.
- Reid, S. N. M. & Juraska, J. M. (1992). Sex differences in the gross size of the rat neocortex. *The Journal of Comparative Neurology*, 321: 442-447.
- Robertson, R. T. Hanes, M. A. & Yu, J. (1988). Investigations of the origins of transient acetylcholinesterase activity in developing rat visual cortex. *Developmental Brain Research*, 41: 1 - 23.
- Rudy, J. W.; Stadler-Morris, S. & Albert, P. (1987). Ontogeny of spatial navigation behaviours in the rat: Dissociation of "proximal"- and "distal"- cue - based behaviors. *Behavioral Neuroscience*, 101(1): 62 - 73.
- Ruppert, C. & Wille, W. (1987). Proto-oncogene c-fos is highly inducible by disruption of neonatal but not mature brain tissue. *Molecular Brain Research*, 2: 51-56.
- Shao, Y. & McCarthy, K. D. (1994). Plasticity of astrocytes. *Glia*, 11: 147-155.
- Sheng, M. & Greenberg, M. E. (1990). The regulation and function of c-fos and other immediate early genes in the nervous system. *Neuron*, 4: 477- 485.
- Sholl, D. A. (1956). *The Organization of the Cerebral Cortex*, Methuen, London.



- Seil, F. J.; Eckenstein, F. P.; Reier, P. J. Induction of dendritic spine proliferation by an astrocyte secreted factor. *Experimental Neurology*, 117: 85-89.
- Sillito, A. M. (1993). The cholinergic neuromodulatory system: An evaluation of its functional roles. In Progress in Brain Research, vol. 98 (A. C. Cuello ed.). Elsevier Science Publishers.
- Stewart, J. and Kolb, B. (1988). The effects of neonatal gonadectomy and prenatal stress on cortical thickness and asymmetry in rats. *Behavioral and Neural Biology*, 49: 344-360.
- Stichel, C. C.; Müller, C. M. & Zilles, K. (1991). Distribution of glial fibrillary acidic protein and vimentin immunoreactivity during rat visual cortex development. *Journal of Neurocytology*, 20:97 - 108.
- Sturrock, R. R. (1986). Postnatal ontogenesis of astrocytes. In Cellular neurobiology of astrocytes, Vol. 1, Development, morphology, and regional specialization of astrocytes. (eds. Federoff, S. & Vernadaleis, A.). pp. 75 - 103, New York, Academic Press.
- Van Eden, C. G. & Uylings, H. B. M. (1985). Postnatal volumetric development of the prefrontal cortex in the rat. *The Journal of Comparative Neurology*, 241: 268-274.
- Van Eden, C. G., Uylings, H. B. M. & Van Pelt, J. (1984). Sex-difference and left-right asymmetries in the prefrontal cortex during postnatal development in the rat. *Developmental Brain Research*, 12: 146-153.
- Vogt, M. B. & Rudy, J. W. (1984). Ontogenesis of learning: I. Variation in the rat's reflexive and learned responses to gustatory stimulation.

*Developmental Psychobiology*, 17: 11 - 33.

- Whishaw, I. Q. (1988). Food wrenching and dodging: Use of action pattern for the analysis of sensorimotor and social behavior in the rat. *Journal of Neuroscience Methods*, 24: 169 - 178.
- Whishaw, I. Q. (1990). Time estimates contribute to food handling decisions by rats: Implications for neural control of hoarding. *Psychobiology*, 18(4): 460 - 466.
- Whishaw, I. Q. & Coles, B. L. K. (1996). Varieties of paw and digit manipulation during spontaneous food handling in rats: Postures, bimanual coordination, preferences, and the effect of forelimb cortex lesions. *Behavioural Brain Research*, 77: 135 - 148.
- Whishaw, I. Q. & Dringenberg, H. C. (1991). How does the rat (*Rattus norvegicus*) adjust food-carrying responses to the influences of distance, effort, predatory odor, food size, and food availability? *Psychobiology*, 19(3): 251 - 261.
- Whishaw, I. Q.; Dringenberg, H. C. & Pellis, S. M. (1992). Spontaneous forelimb grasping in free feeding by rats: Motor cortex aids limb and digit positioning. *Behavioural Brain Research*, 48: 113 -125.
- Whishaw, I. Q. & Gorny, B. P. (1994). Arpeggio and fractionated digit movements used in prehension by rats. *Behavioural Brain Research*, 60: 15 - 24.
- Whishaw, I. Q.; Gorny, B. P. & Dringenberg, H. C. (1991). The defensive strategies of foraging rats: A review and synthesis. *The Psychological Record*, 41: 185 - 205.

- Whishaw, I. Q. & Kolb, B. (1988). Sparing of skilled forelimb reaching and corticospinal projections after neonatal motor cortex removal or hemidecortication in the rat: Support for the Kennard doctrine. *Brain Research*, 451: 97 - 114.
- Whishaw, I. Q.; Kolb, B.; Sutherland, R. J. & Becker, J. B. (1983). Cortical control of claw cutting in the rat. *Behavioral Neuroscience*, 97(3): 370 - 380.
- Whishaw, I. Q.; Nicholson, L. & Oddie, S. D. (1989). Food-pellet size directs hoarding in rats. *Bulletin of the Psychonomic Society*, 27(1): 57 - 59.
- Whishaw, I. Q.; O'Connor, W. T. & Dunnett, S. B. (1986). The contributions of motor cortex, nigrostriatal dopamine and caudate-putamen to skilled forelimb use in the rat. *Brain*, 109: 805 - 843.
- Whishaw, I. Q.; Oddie, S. D.; McNamara, R. K.; Harris, T. L. & Perry, B. S. (1990). Psychophysical methods for study of sensory-motor behavior using a food-carrying (hoarding) task in rodents. *Journal of Neuroscience Methods*, 32: 123 - 133.
- Whishaw, I. Q. & Pellis, S. M. (1990). The structure of skilled forelimb reaching in the rat: A proximally driven movement with a single distal rotary component. *Behavioral Brain Research*, 41: 49 - 59.
- Whishaw, I. Q.; Pellis, S. M.; Gorny, B. P. & Pellis, V. C. (1991). The impairments in reaching and the movements of compensation in rats with motor cortex lesions: An endpoint, videorecording, and movement notation analysis. *Behavioural Brain Research*, 42: 77 - 91.
- Whishaw, I. Q. & Tomie, J-A. (1987). Food wresting and dodging: Strategies

used by rats (*Rattus norvegicus*) for obtaining and protecting food from conspecifics. *Journal of Comparative Psychology*, 101: 202-209.

Whishaw, I. Q. & Tomie, J-A. (1988). Food wrenching and dodging: A neuroethological test of cortical and dopaminergic contributions to sensorimotor behaviour in the rat. *Behavioral Neuroscience*, 102(1): 110-123.

Whishaw, I. Q. & Tomie, J-A. (1989). Olfaction directs skilled forelimb reaching in the rat. *Behavioural Brain Research*, 32: 11 - 21.

Whishaw, I. Q. & Tomie, J-A. (1989). Food-pellet size modifies the hoarding behavior of foraging rats. *Psychobiology*, 17(1): 93 - 101.

Yanai, J. (1979). Delayed maturation of the male cerebral cortex in rats. *Acta Anatomica*, 104: 335-339.

Young, R. M. (1970). Mind, brain and adaptation in the nineteenth century: Cerebral localization and its biological context from Gall to Ferrier. Clarendon Press, Oxford.

Zilles, K. (1985). The cortex of the rat: A stereotaxic atlas. Springer-Verlag, Berlin Heidelberg.