

BASIC FIBROBLAST GROWTH FACTOR ENHANCES RECOVERY IN RATS

WENDY LOU WAITE

BA., Okanagan University College, 2001

A Thesis

Submitted to the School of Graduate Studies of the
University of Lethbridge in Partial Fulfillment of the
Requirements for the Degree

MASTER OF SCIENCE

Department of Psychology and Neuroscience

University of Lethbridge

LETHBRIDGE, ALBERTA

July, 2003

© Wendy Lou Waite, 2003

DEDICATION

To Travis

..... the man whom I have adored and admired all his life, my son.....

Your unfaltering belief in me gave me strength when I needed it most.

THESIS ABSTRACT

This thesis examined the role of exogenous basic fibroblast growth factor (FGF-2) in stimulating recovery after early cortical injury. Rats with medial prefrontal cortex (MFC), posterior parietal cortex (PPC), or sham lesions at postnatal day 3 (P3) received one of three variations of FGF-2 treatment: postnatal FGF-2 that was either pre-mixed or prepared daily, or prenatal FGF-2, and tested in adulthood. Behavioral tests used were: 1) the Morris Water task and, 2) the Whishaw Tray Reaching task. The level of functional recovery attained was dependent on FGF-2 preparation and the developmental period. MFC lesion rats showed good recovery but there was a differential effect of pre and postnatal FGF-2 that appeared to be related to task. PPC rats showed greater recovery after postnatal rather than prenatal treatment. Anatomical changes were restricted to groups with relatively good functional recovery. These findings suggest a multifunctional role of FGF-2 in the injured brain.

ACKNOWLEDGEMENT

I would like to thank those who gave more of themselves than what was expected. Cathy Carroll deserves acknowledgement for always looking out for me and making sure that I kept grounded and on schedule (more or less).

The technical support from Grazyna Gorny and Dawn Danka was greatly appreciated, as was their willingness to teach and guide me through uncharted waters. I owe a very special thanks to Greg Salalis for his endless assistance and for sharing his expertise with me. Students, Kelly McAllister and Anne Hodgson deserve thanks for giving up their time when I needed “Just one more measure”. I would also like to thank Morgan Day for her help with the animals and Marie Monfils for her input.

I would also like to thank Claudia Gonzalez-Walton for her time and input whenever I came up with another “what if...?” Of course, not many, if any, student could say they had completed a degree in neuroscience at the University of Lethbridge without drawing on the never-ending source of knowledge, Robbin Gibb. I probably owe her more gratitude than most as she has been my mentor and guide for the last two years and has always given of her time.

I also would like to thank Dr. Rob Sutherland and Dr. Glenn Prusky for taking the time to answer my questions. As well, I owe thanks to Dr. Ian Wishaw for willingly giving his advice and time when I was questioning myself as a behavioral experimenter.

The members of my committee, Dr.s Jeff Kleim and Stewart Rood deserve thanks for their time, input, and support. And of course, I owe a world of thanks to Dr. Bryan Kolb for being not only my supervisor, but my critic, neuroscience dictionary, and supporter. He has shown infinite patience, which I know I often tried. As well, I will be

forever grateful to Bryan for giving me this opportunity and for having the stamina to take on another degree with me.

I would like to thank my co-conspirator, and friend, Erica Hastings who went through the many hours of testing and writing along side of me. Your friendship has made the last two years so much more enjoyable.

My acknowledgements would not be complete without mentioning Dr. Jan Cioe, thank you for believing in me and always expecting more of me. You have been my mentor, friend, and my rock when I was faltering.

Finally, I owe a special thanks to my family, especially my mother and sister, Betty, as well as my surrogate family the Kemaldeans, all of whom have been a wealth of support and encouragement throughout the past two years.

BASIC FIBROBLAST GROWTH FACTOR ENHANCES RECOVERY IN RATS

TABLE OF CONTENTS

THE POTENTIAL FOR PLASTICITY

1. GENERAL INTRODUCTION.....	1
1.2 BRAIN PLASTICITY	3
<i>1.2.1 What Is Plasticity?</i>	<i>3</i>
<i>1.2.2 Mechanisms of Plasticity</i>	<i>3</i>
<i>1.2.3 Embryonic Mechanisms of Plasticity.....</i>	<i>4</i>
<i>1.2.4 Postnatal Mechanisms of Plasticity.....</i>	<i>5</i>
1.3 BASIC FIBROBLAST GROWTH FACTOR.....	9
<i>1.3.1. FGF-2: What is it?.....</i>	<i>10</i>
<i>1.3.2 FGF-2 Localization.....</i>	<i>11</i>
<i>1.3.3 FGF-2 Functions</i>	<i>13</i>
<i>1.3.4 Role of FGF-2 in response to Injury.....</i>	<i>14</i>
1.4 CORTICAL DEVELOPMENT.....	16
<i>1.4.1 Neurogenesis</i>	<i>17</i>
<i>1.4.2 Migration.....</i>	<i>19</i>
<i>1.4.3 Differentiation.....</i>	<i>20</i>

1.5 BRAIN INJURY AND RECOVERY	20
<i>1.5.1. Age of Injury</i>	<i>21</i>
<i>1.5.2. Location of Injury</i>	<i>22</i>
<i>1.5.3. Bilateral Medial Frontal Cortical Injury and Age</i>	<i>22</i>
<i>1.5.4. Bilateral Posterior Parietal Cortical Injury and Age</i>	<i>24</i>
<i>1.5.5. Previous Treatment Strategies.....</i>	<i>27</i>
1.6 SUMMARY	28
1.7 RESEARCH APPROACH.....	29
1.8 BEHAVIORAL AND ANATOMICAL MEASURES	30
2. EXPERIMENT 1: POSTNATAL FGF-2 AFTER MEDIAL FRONTAL OR POSTERIOR PARIETAL CORTICAL LESIONS	36
2.1 INTRODUCTION.....	37
2.2 MATERIALS AND METHODS	39
<i>2.2.1. Subject</i>	<i>39</i>
<i>2.2.2. Surgical Procedures.....</i>	<i>40</i>
<i>2.2.3. Injections.....</i>	<i>41</i>
<i>2.2.4. Histology.....</i>	<i>41</i>
<i>2.2.5. Anatomical Measurements</i>	<i>41</i>
<i>2.2.6. Behavioural Procedures</i>	<i>45</i>
<i>2.2.7. Statistical methods.....</i>	<i>48</i>

2.3 RESULTS	49
2.3.1. ANATOMICAL RESULTS (MFC)	49
<i>2.3.1.1. Body Weight</i>	49
<i>2.3.1.2. Brain weight</i>	50
<i>2.3.1.3. Cerebellum SA</i>	50
<i>2.3.1.4. Cortical SA</i>	51
<i>2.3.1.5. Lesion SA</i>	52
<i>2.3.1.6. Cortical thickness</i>	53
<i>2.3.1.7. Anterior and Posterior Thalamic sections</i>	56
2.3.2. BEHAVIOURAL RESULTS (MFC)	57
<i>2.3.2.1. Morris Water Task</i>	57
<i>2.3.2.2. Whishaw Tray Reaching Task</i>	61
<i>2.3.2.3. Open field task</i>	62
2.3.3. ANATOMICAL RESULTS (PPC)	62
<i>2.3.3.1. Body Weight</i>	62
<i>2.3.3.2. Brain weight</i>	63
<i>2.3.3.3. Cerebellum SA</i>	64
<i>2.3.3.4. Cortical SA</i>	65
<i>2.3.3.5. Cortical thickness</i>	66

2.3.3.6. <i>Anterior and Posterior Thalamic sections</i>	69
2.3.3.7. <i>Lateral posterior thalamic nuclei</i>	70
2.3.4. BEHAVIOURAL RESULTS (PPC)	75
2.3.4.1. <i>Morris Water Task</i>	75
2.3.4.2. <i>Whishaw Tray Reaching Task</i>	78
2.3.4.3. <i>Open field task</i>	79
2.4 DISCUSSION	80
2.4.1. <i>Effects of lesion on cognitive and motor tasks</i>	81
2.4.2. <i>Anatomical irregularities</i>	82
2.4.3. <i>Impact of FGF-2 on behavioural and anatomical results</i>	83
2.4.3. <i>Procedural problems and implications</i>	84
3. EXPERIMENT 2: POSTNATAL FGF-2 AFTER MEDIAL FRONTAL OR POSTERIOR PARIETAL CORTICAL LESIONS	86
3.1 INTRODUCTION	87
3.2 MATERIALS AND METHODS	89
3.2.1. <i>Subject</i>	89
3.2.2. <i>Surgical Procedures</i>	90
3.2.3. <i>FGF-2 Preparation</i>	90
3.2.4. <i>Behavioural procedures</i>	90
3.2.5. <i>Statistical methods</i>	91

3.3 RESULTS	92
3.3.1. ANATOMICAL RESULTS (MFC)	92
<i>3.3.1.1. Body Weight</i>	92
<i>3.3.1.2. Brain weight</i>	93
<i>3.3.1.3. Cerebellum SA</i>	94
<i>3.3.1.4. Cortical SA</i>	95
<i>3.3.1.5. Lesion SA</i>	96
<i>3.3.1.6. Cortical thickness</i>	97
<i>3.3.1.7. Anterior and Posterior Thalamic sections</i>	100
3.3.2. BEHAVIOURAL RESULTS (MFC)	101
<i>3.3.2.1. Morris Water Task</i>	101
<i>3.3.2.2. Whishaw Tray Reaching Task</i>	104
<i>3.3.2.3. Open field task</i>	105
3.3.3. ANATOMICAL RESULTS (PPC)	106
<i>3.3.3.1. Body Weight</i>	106
<i>3.3.3.2. Brain weight</i>	107
<i>3.3.3.3. Cerebellum SA</i>	108
<i>3.3.3.4. Cortical SA</i>	109
<i>3.3.3.5. Cortical thickness</i>	110

3.3.3.6. <i>Anterior and Posterior Thalamic sections</i>	113
3.3.3.7. <i>Lateral posterior thalamic nuclei</i>	114
3.3.4. BEHAVIOURAL RESULTS (PPC)	120
3.3.4.1. <i>Morris Water Task</i>	120
3.3.4.2. <i>Whishaw Tray Reaching Task</i>	123
3.3.4.3. <i>Open field task</i>	124
3.4 DISCUSSION	125
3.4.1. <i>Effects of lesion on cognitive and motor tasks</i>	126
3.4.2. <i>Anatomical irregularities</i>	127
3.4.3. <i>Impact of FGF-2 on behavioural and anatomical results</i>	128
4. EXPERIMENT 3: PRENATAL FGF-2 AFTER MEDIAL FRONTAL OR	
POSTERIOR PARIETAL CORTICAL LESIONS	131
4.1 INTRODUCTION	132
4.2 MATERIALS AND METHODS	137
4.2.1. <i>Subject</i>	137
4.2.2. <i>Prenatal FGF-2</i>	138
4.2.3. <i>Surgical Procedures</i>	139
4.2.4. <i>Histology</i>	140
4.2.5. <i>Anatomical Measurements</i>	140
4.2.6. <i>Behavioural testing</i>	143

4.2.7. <i>Statistical methods</i>	147
4.3 RESULTS	147
4.3.1. ANATOMICAL RESULTS (MFC)	147
4.3.1.1. <i>Body Weight</i>	147
4.3.1.2. <i>Brain weight</i>	148
4.3.1.3. <i>Cerebellum SA</i>	149
4.3.1.4. <i>Coritcal SA</i>	150
4.3.1.5. <i>Lesion SA</i>	151
4.3.1.6. <i>Cortical thickness</i>	152
4.3.1.7. <i>Thalamic and brain stem sections</i>	155
4.3.2. BEHAVIOURAL RESULTS (MFC)	156
4.3.2.1. <i>Morris Water Task</i>	156
4.3.2.2. <i>Whishaw Tray Reaching Task</i>	159
4.3.2.3. <i>Open field task</i>	160
4.3.3. ANATOMICAL RESULTS (PPC)	161
4.3.3.1. <i>General observations</i>	161
4.3.3.2. <i>Body Weight</i>	162
4.3.3.3. <i>Brain weight</i>	163

4.3.3.4. <i>Cerebellum SA</i>	164
4.3.3.5. <i>Cortical SA</i>	165
4.3.3.6. <i>Cortical thickness</i>	166
4.3.3.7. <i>Thalamic and brain stem sections</i>	169
4.3.3.8. <i>Lateral posterior thalamic nuclei</i>	170
4.3.4. BEHAVIOURAL RESULTS (PPC).....	175
4.3.4.1. <i>Morris Water Task</i>	175
4.3.4.2. <i>Whishaw Tray Reaching Task</i>	177
4.3.4.3. <i>Open field task</i>	178
4.4 DISCUSSION	180
4.4.1. <i>Effects of lesion on cognitive and motor tasks</i>	181
4.4.2. <i>Anatomical irregularities</i>	182
4.4.3. <i>Impact of PreFGF on behavioural functional results</i>	183
4.4.4. <i>Impact of PreFGF on anatomical irregularities</i>	184
5. GENERAL DISCUSSION	185
5.1 PRINCIPAL FINDINGS.....	187
5.1.1. FGF-2 ENHANCES FUNCTIONAL RECOVERY	188
5.1.2. FGF-2 AFFECT MFC AND PPC LESIONS DIFFERENTLY....	189
5.1.3. DEVELOPMENTAL AGE INFLUENCES FGF-2 AFFECT	191

5.1.4. INTACT BRAIN REACTS DIFFERENTLY TO FGF-2	193
5.1.5. MECHANISMS OF PRENATAL FGF-2.....	194
5.1.6. FUTURE DIRECTIONS.....	196
CONCLUSION	196
REFERENCES.....	198
6. APPENDIX 1.....	210
7. APPENDIX 2.....	213

LIST OF ABBREVIATIONS

ANOVA	Analysis of variance
BrdU	Bromodeoxyuridine
Cg	Cingulate cortex
E	Embryonic day
F	Female
FGF-2	Basic fibroblast growth factor
Fr	Frontal cortex
LP	Lateral posterior thalamic nucleus
LSD	Least significant difference
M	Male
MD	Medial dorsal thalamic nuclei
MFC	Medial prefrontal cortex
MWT	Morris water maze task
NGF	Nerve growth factor
NTF	Neurotrophic factors
P	Postnatal day
PostFGF	Postnatal basic fibroblast growth factor
PPC	Posterior parietal cortex
PreFGF	Prenatal basic fibroblast growth factor
SA	Surface area
SEM	Standard error of the mean
SVZ	Subventricular zone

BASIC FIBROBLAST GROWTH FACTOR ENHANCES RECOVERY IN RATS
THE POTENTIAL FOR PLASTICITY

1. GENERAL INTRODUCTION

Research into the potential for recovery of function following brain injury has largely focused on the brain's capacity for change, a process referred to as brain plasticity. The basis of this work relies on the assumption that the amount of attainable plasticity will determine the level of functional recovery that is possible. It has been presumed that the developing brain is more plastic than the mature brain. The developing brain, however, is continually changing and it is now becoming clear that there are specific stages of development that show more or less plasticity. The idea that mechanisms that are operating during these particular stages of development may also be made available to the mature brain has prompted the present research. Understanding what controls the level of plasticity during these periods is important to understanding recovery may be enhanced in the mature brain, perhaps by stimulating specific mechanisms of plasticity.

The endogenous production of a variety of chemical factors, one class of which are neurotrophic factors (NTFs), varies during developmental stages. One NTF that is of particular interest in this regard is basic fibroblast growth factor (FGF-2). FGF-2 is an endogenous protein that is found in the brain at varying levels during all stages of cortical development and throughout life. FGF-2 is a multifunctional NTF that plays a role both in neurogenesis and as an agent in neuronal survival and differentiation. Endogenous

levels of FGF-2 vary with experience and its role in development and later life makes it a prime candidate in enhancing brain plasticity after injury.

The experiments in this thesis were designed to examine the role of FGF-2 in brain plasticity after injury to the developing brain. FGF-2 was administered either prenatally, at a time that FGF-2 is known to potentiate neurogenesis, or postnatally following a perinatal brain injury. Two different focal lesion models of early brain injury were examined; namely the effects of injury to the medial prefrontal cortex (MFC) and the posterior parietal cortex (PPC). Injury to either of these cortical regions during the first few days of life is associated with a dismal functional outcome that provides an increased potential for stimulating enhanced behavioral recovery.

What follows is a review of the mechanisms thought to be involved in brain plasticity. Owing to the differing mechanisms that are available prenatally and postnatally, these developmental periods will be addressed separately. Next, the fundamental processes involved in cortical development that demonstrates periods of vulnerability and plasticity will be reviewed. A consideration of the role of FGF-2 in the brain plasticity and its involvement in these developmental processes will follow. From there, a consideration of the effects of early perinatal lesions on later functioning will be discussed.

1.2 BRAIN PLASTICITY

1.2.1 What Is Plasticity?

Brain plasticity refers to the brain's capacity for change. These changes take various forms and are both structural and functional in nature (Kolb & Whishaw, 1998b). Although some consider plasticity to include all molecular events that may occur in response to internal/external stimuli, the current thesis assumes a narrower definition in which plasticity is assumed to reflect structural change and to be semi-permanent in nature. So although there may be changes in ion channels and fluctuations in spine density, these changes are considered to be mechanisms of plasticity that may or may not induce long-lasting structural changes. There is accumulating evidence to suggest that the structural changes lead to functional changes, thus the ability to enhance functional recovery following injury (for review see Kolb, 1995). Much of the recent research, and the present study, have been based on this assumption, and have focused on uncovering both the mechanisms involved and their regulatory processes.

1.2.2 Mechanisms of Plasticity

In the cortex, mechanisms of brain plasticity may include changes in axonal outgrowth, dendritic morphology, such as dendritic branching and spine density, or changes in protein synthesis and neural activity, as well as regulated cell death referred to as apoptosis, to name a few (Kolb & Whishaw, 1998a). An additional mechanism of plasticity is neurogenesis, although it appears to be stimulated only under very specific circumstances (Biebl, Cooper, Winkler & Kuhn, 2000; Kuhn, Palmer & Fuchs, 2001).

To conclude that a mechanism is involved in plasticity requires that the mechanism in question changes when the requirements of the brain change. For example, there is a consistent correlation between learning or experience and changes in dendritic morphology (Black, Isaacs, Anderson, Alcantara & Greenough, 1990; Kolb & Whishaw, 1998a). Changes in dendritic morphology overlap with learning, and learning does not occur in the absence of dendritic changes. A more specific example is the increased or decreased spine density in the barrel cortex of the rat that coincides with either experience or deprivation of sensory information (Lendvai, Stern, Chen & Svoboda, 2000). Learning and experience are also proposed to be associated with neurogenesis in the hippocampus even in adulthood (Kuhn *et al.*, 2001). Yet, these mechanisms are not acting in isolation and are often interrelated, as part of a much more complex process. Furthermore, they are constricted by internal and external environmental factors that affect the availability and degree of change that takes place (e.g., Kolb, 1995). One such factor is age, and will be reviewed in the sections that follow.

1.2.3 Embryonic Mechanisms of Plasticity

During embryonic development many of the mechanisms of plasticity available to the postnatal brain do not yet exist. The most prevalent mechanism during this time is neurogenesis. Yet, although neurogenesis in the rat fetus continues until birth, the prenatal brain is both vulnerable and resilient depending on the phase of development. During periods of cortical neurogenesis, coinciding with embryonic days (E) 12 – 21 in the rat, there are periods when the brain is very plastic and periods when it is not. For example, at about E18 - E19 in the rat, compensation and regeneration occur after a

substantial neuronal loss and, although there are structural abnormalities, the animal shows few signs of behavioral deficits (e.g., Hicks & D'amato, 1978; Kolb, Cioe & Muirhead, 1998). Yet, E19 – E22 may result in more severe cortical malformations. Hicks and D'Amato (1961) suggested that the explanation for the disparity in plasticity may be due, in part, to the type, rather than the timing, of the loss. The primitive proliferating neurons seem able to replenish neuronal numbers when needed but later, when the last of the neurons are migrating, there are few replacement cells, thus a more severe outcome following insult. As well, insult at E16 – E17 results in a disruption of thalamocortical connections and gross disorganization of the developing cortex (Hicks & D'amato, 1961). The disruption in migration will frequently lead to cortical layers developing beneath the cortical plate, rather than above it. Furthermore, the loss of postmitotic cells at this time causes a disruption in signals required for thalamocortical connections, thus many thalamic fibers are without a developmental course and may even leave the cortex, settling in the meninges.

It should be noted that the cells most sensitive to insult are the cells that have just become postmitotic cells (Hicks & D'amato, 1961). From the above example it appears that there is something special about the period of neurogenesis around E18 that tolerates change. Of course neurogenesis is not occurring in a vacuum and other developmental factors, such as the neurochemical environment are likely involved.

1.2.4 Postnatal Mechanisms of Plasticity

Just as specific prenatal phases may determine the level of plasticity, the same appears to be true in the postnatal CNS. Cortical neurogenesis is basically complete by birth, or postnatal day (P) 0, but other mechanisms of plasticity are now appearing. For

instance, synaptogenesis peaks shortly after birth (for review see Kolb & Whishaw, 1989), and may allow for a higher degree of plasticity. With a limited number of available connections, competition is high during this period. The brain has an over abundance of neurons at birth, but only a portion will make the appropriate connections and survive (Kolb & Whishaw, 1989). The rest will fail to make connections and succumb to a process of programmed cell death referred to as apoptosis. Thus, it would seem likely that connections lost due to cell death at this time could be replaced by new connections from competing neurons that have as yet not made connections. Furthermore, many of the neuronal connections are not yet functionally committed which would permit neurons to reorganize and make new intrinsic connections as partial compensation for a loss of connectivity. These processes all rely on changes in cell morphology of existing neurons as a mechanism of plasticity. More recently, however, there is new evidence to suggest the possibility of generating new neurons in the postnatal cortex (e.g., Kolb, Witt-Lajeunesse & Gibb, 2001).

Neurogenesis does occur in the mature brain but new cells are generally believed to be restricted to areas such as the olfactory bulbs and the hippocampus, which regenerate throughout life. Both of these areas rely on stem cells present in the postnatal brain. Stem cells give rise to other stem cells and/or progenitor cells (Sharp, Liu & Bernabeu, 2001). Progenitor cells are capable of becoming neurons, astrocytes or oligodendrocytes. These cells reside in the subventricular zone (SVZ) that lies adjacent to the lateral ventricle (Doetsch, Gardia-Verdugo & Alvarez-Buylla, 1997), the hippocampus, and the spinal cord (Weiss, Dunne, Hewson, Wohl, Wheatley, Peterson & Reynolds, 1996) in the mature brain (see Figure1-1). Unlike the hippocampus, the

olfactory bulb is not a proliferative zone, but instead obtains replenishing neurons from the SVZ. These cells must migrate via the rostral migratory stream (RMS) to the olfactory bulb (Sharp *et al.*, 2001).

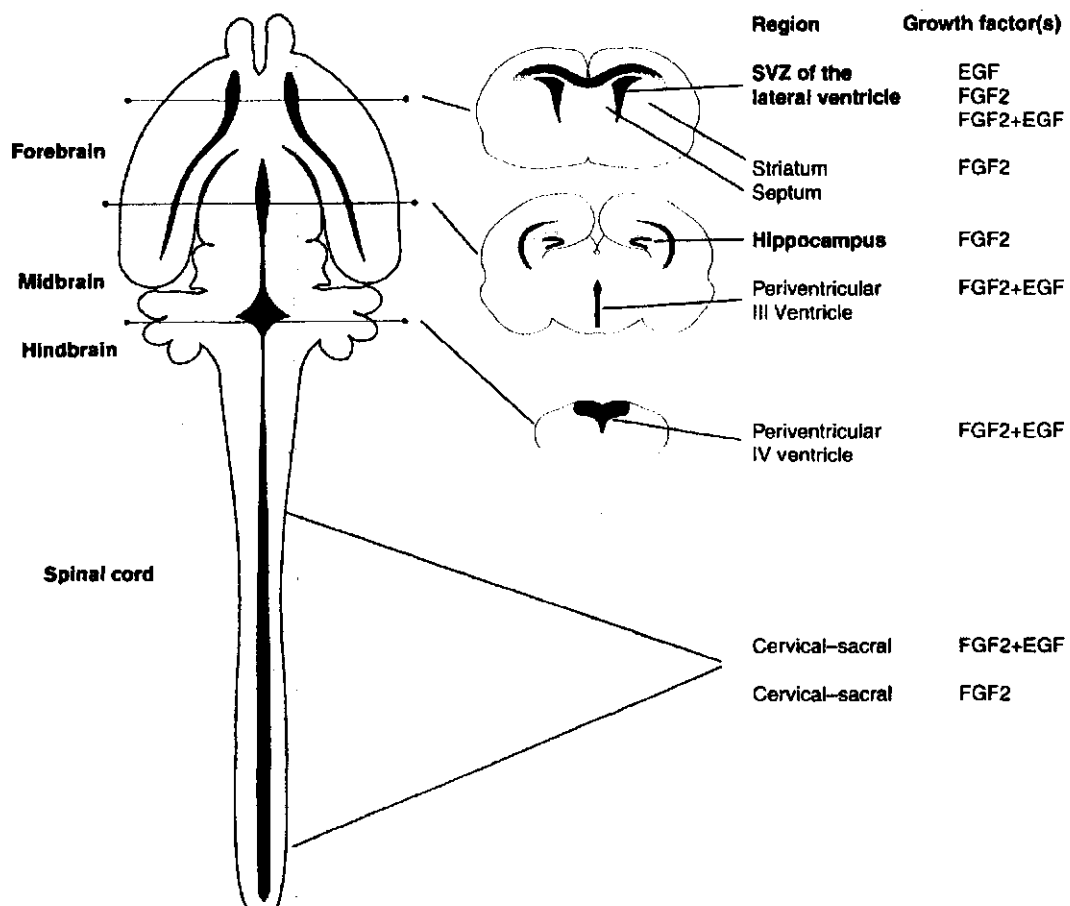

Figure 1-1. A cartoon of the neuroaxis where stem cells have been located. A corresponding list of growth factors used to isolate the stem cell (From Temple & Alvarez-Buylla, 1999, p. 136).

Whether migrating cells are restricted to the RMS environment is now being questioned. It may be possible that these cells are able to leave the RMS (see Figure 1-2) and reroute to other brain regions under special circumstances, such as pathological insult, to aide in the restructuring of the compromised area (Kolb, Gibb, Gorny &

Whishaw, 1998). Support for this notion comes from a study by Kirschenbaum and colleagues (1999) who reported that neuronal precursors from the adult SVZ continued to proliferate and migrate even when the olfactory bulb had been removed. Although the process appeared to slow down, it does suggest that neurogenesis was not solely reliant on interactions with the olfactory bulb and may respond to other signaling systems (Sharp *et al.*, 2001). Furthermore, whether or not the new neurons produced in the SVZ are strictly for use in olfactory bulb replenishment is now being questioned (Gould, Reeves, Graziano & Gross, 1999).

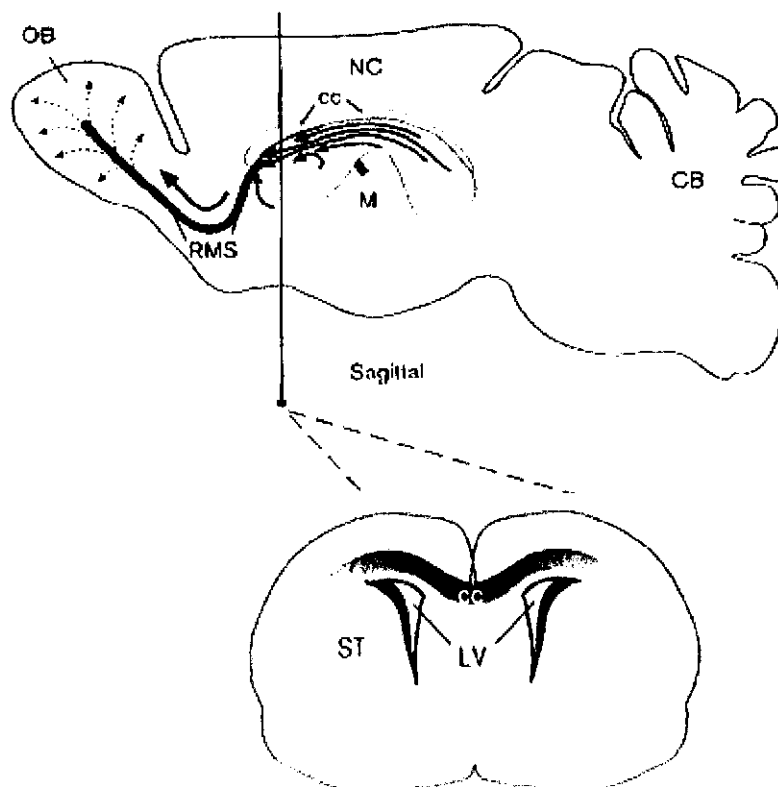

Figure 1-2. *Illustration of the rostral migratory stream (RMS) where cells originating in the SVZ travel enroute to the olfactory bulbs (Temple & Alvarez-Buylla, 1999).*

Pathological insult may also play a role in stimulating neurogenesis in the hippocampus. Sharp and colleagues (2001) found increased cell proliferation in the hippocampus seven days post-injury that peaked by day 11 and then decreased, suggesting a response that may serve as a compensatory mechanism following insult or injury of the CNS in the rat. Adult neurogenesis is not unique to rodents and primates, as strong evidence now exists for adult neurogenesis in the human hippocampus as well (Erickson, Perfilieva, Bjork-Erickson, Alborn, Nordborg, Peterson & Gage, 1998). Human hippocampal tissue slices were taken from a study of terminally ill patients, whom had received a mitotic marker, bromodeoxyuridine (BrdU), to monitor tumor growth and later died from their illness. The tissue showed new neurons were present in the granule cell layers of all patients sampled.

In light of the increasing evidence in support of adult neurogenesis, brain regions other than the SVZ and hippocampus that were once thought to be the lone sites of new neurons are now being examined for signs of adult neurogenesis. It now appears that the occurrence of neurogenesis in response to pathological situations may also occur in other areas of the mature brain (Kuhn *et al.*, 2001). Findings in recent research suggest that immature progenitor cells also reside in the neocortex of the mouse and are capable of becoming neurons in the right environment (Magavi, Leavitt & Macklis, 2000).

1.3. BASIC FIBROBLAST GROWTH FACTOR (FGF-2)

A fundamental role of neurotrophic factors in both the central and peripheral nervous systems is cell differentiation and maturation (e.g., Mocchetti & Wrathall, 1995). Neurotrophic factors can be classified based on either their functional activity or in

relation to their specific polypeptide sequences. An example is the family of fibroblast growth factors (FGFs) that are related through their characteristic binding to heparin receptors. Aside from cell mitosis, differentiation and maturation, (Kawamata et al., 1997; Mocchetti & Wrathall, 1995), FGFs are also involved in morphogenesis, tissue repair and cell maintenance (e.g., Abe & Saito, 2001; Bieger & Unsicker, 1996), as well as angiogenesis (e.g., Cuevas, Gimenez-Gallego, Carceller, Cuevas & Crespo, 1993), and synaptogenesis (e.g., Schnider & Poo, 2000).

1.3.1. FGF-2: What is it?

FGF-2 is one of at least nine known FGFs (Bieger & Unsicker, 1996), and one of two that are best represented in the brain (Gomez-Pinilla, Lee & Cotman, 1994). A single-chain polypeptide, FGF-2 is a protein composed of 146 amino acids with ranges of 18 to 24 kilodalton (kDa) (Abe & Saito, 2001; Gospodarowicz, 1990; Gospodarowicz, Neufeld & Schweiger, 1986; Prats, Kaghad, Prats, Klagsbrun, Lelias, Smith & Caput, 1989). Most cells, however, produce the 18 kDa or lower mass form of FGF-2 (Prats *et al.*, 1989).

FGFs bind to both low and high-affinity receptors. The binding of FGFs to its low-affinity receptor, heparin, supports two mechanisms; one that holds the FGFs in a dormant state with heparin sulfate proteoglycans and provides protection from heat and acid inactivation (Gospodarowicz, 1990), and a second mechanism whereby the proteoglycans transport FGF to its high-affinity tyrosine kinase receptors on the cell membrane (Baird, 1994; Lin & Finklestein, 1997). The binding to its high affinity

receptor increases the expression of cytoprotective genes and their proteins within the cell.

1.3.2 FGF-2 Localization

FGF-2 is found in both the peripheral and central nervous system (CNS). Although specific neuron populations synthesize FGF-2 (Abe & Saito, 2001; Emoto, Gonzalez, Walicke, Wado, Simmons, Shimasaki & Baird, 1989), the primary manufacturers of this protein are astrocytes (Bieger & Unsicker, 1996; Emoto *et al.*, 1989).

In the CNS, different brain regions show varying levels of FGF-2. For example, during development FGF-2 is highly expressed in the subplate but is no longer present in subplate neurons of the mature brain. The highest levels of FGF-2 in adulthood are found in the cerebral cortex, the hippocampus and the spinal cord (Riva & Mochetti, 1991). Yet, during development, FGF-2 is expressed transiently in various regions during different stages of development (Gomez-Pinilla *et al.*, 1994; Riva & Mochetti, 1991; Schinder & Poo, 2000).

On E13, FGF-2 is found throughout much of the CNS, though its expression is sparse (Gomez-Pinilla *et al.*, 1994). By E17.5 however, FGF-2 is down-regulated and immunoreactivity all but disappears from the PVE (Raballo, Rhee, & Lyn-Cook, 2000). At this time, about E18, FGF-2 is more restricted to specific cell populations, with increased labeling in the cortical plate, subplate and ventricular zone, as well as other subcortical structures of the developing rat brain (Gomez-Pinilla *et al.*, 1994). By P1, FGF-2 expression is restricted even further to specific cell populations and only present

in the cerebral cortex reservoir (lateral to the neuroepithelium). It is not until postnatal day 4 - 6 that astrocytes begin to show FGF-2 immunoreactivity (Gomez-Pinilla *et al.*, 1994). As cortical astrocytes are at a minimal level prior to this time, it suggests that there is a period of low FGF-2 expression in rats for the first postnatal week. By P10 – P20, however, there is an increase of FGF-2 and astrocytes throughout the brain show strong FGF-2 labeling (Caday, Klagsbrun, Fanning, Mirzabegian & Finklestein, 1990; Gomez-Pinilla *et al.*, 1994). In contrast, adult levels of neuronal FGF-2 immunoreactivity in the cerebral cortex is mainly limited to the cingulate cortex (Gomez-Pinilla *et al.*, 1994).

1.3.3 FGF-2 Functions

In 1986, Walicke and colleagues published some of the first research suggesting fibroblast growth factors are essential for the survival of some neurons in the CNS. Since then a multitude of research on FGF-2 has shown that it is a multifunctional growth factor with actions on neurons, as well as glial cells (e.g., Abe & Saito, 2001; Emoto *et al.*, 1989). There is evidence that it has neurotrophic, gliotrophic, synaptogenic and angiogenic functions. Furthermore, the functions of FGF-2 postnatally appear to be different than the functions served prenatally (see Table 1-1).

Prenatal Prenatally, FGF-2 influences neurogenesis. Yet, its exact role is still under debate. Ghosh *et al.*, (1995) found that although FGF-2 influenced proliferation, it did not have an effect on mitosis. Other studies have reported contrary findings in that FGF-2 is required, both *in vitro* and *in vivo*, for proliferating cells to divide (Qian, Davis, Goderie & Temple, 1997). In fact, it may even be that FGF-2 influences cell type, although this has yet to be supported (Cameron, Hazel & McKay, 1998). It seems that

FGF-2 also plays a mitogenic and inhibitory role in glia differentiation prenatally (Engele & Bohn, 1992). The high expression of FGF-2 during early stages of cortical development may inhibit the differentiation of glia. Thus, the low levels at the end of embryonic development and into the first postnatal week may permit the increased proliferation of glia occurring at that time.

Table 1-1 *Summary of prenatal and postnatal FGF-2 function in the CNS*

Role	Definition	Developmental Period
Neurotrophic	Neuron support, outgrowth	Postnatal
Gliatrophic	Glia survival, proliferation	Postnatal
Angiogenic	Capillary proliferation	Postnatal, prenatal
Synaptogenic	Synapse formation	Postnatal
Promote neurogenesis	Mitotic activity	Prenatal, postnatal

Postnatal Postnatally, the transient levels of FGF-2 expression suggest it has stage-specific functions that are also regionally-specific. For example, Riva and Mocchetti (1991) reported higher levels of FGF-2 mRNA in the spinal cord in week 1 that corresponds with neuron and glial differentiation (Altman & Bayer, 1984), whereas increased levels of FGF-2 mRNA in the hippocampus at P21 corresponds with synaptogenesis. In the mature cortex, the highest levels of FGF-2 are found in regions of the brain that continue to proliferate throughout life, namely the hippocampus and subventricular zone (Gomez-Pinilla et al., 1994).

1.3.4 Role of FGF-2 in response to Injury

Both reactive astrocytes and injured neurons have shown an increased synthesis of FGF-2 in response to injury (Chadi & Fuxe, 1998). Following injury, FGF-2 initiates a cascade of events that directs survival, differentiation and maturation of CNS neurons (Lin & Finklestein, 1997). One proposed mechanism by which FGF-2 may influence cell survival following cerebral ischemia (e.g., stroke), is through binding to its high-affinity receptor (see Figure 1-3). Immediately following stroke, a series of toxic events, such as glutamate release (excitotoxicity), an induction of free radicals (membrane comprising factors), calcium influx into cell (membrane and cytoskeleton damage) and apoptosis (programmed cell death) take place in and around the neuron (Mattson & Cheng, 1993). By binding to the high affinity tyrosine kinase receptor, FGF-2 acts as a counterbalance mechanism by initializing a series of signals that trigger the expression of cytoprotective genes and their proteins. The purpose being to offset the effects of the toxic events taking place, thereby increasing the chance of neuronal survival (Lin & Finklestein, 1997).

Although this is not the only possible mechanism by which FGF-2 may act on the injured brain, a large amount of research does support a role in neuronal rescue and survival. In adult rats with entorhinal lesions, an increase in astrocytic FGF-2 production is induced by post-lesion day 2, peaking on post-lesion day 7 (Gomez-Pinilla, 1992,). In both adult and neonatal rats, exogenous FGF-2 weakened chemical hypoxia injury (Kirschner et al., 1995). As well, it has been reported that pretreatment with FGF-2 acts to reduce infarct size in adult lesion rats (Koketsu, Berlove, Moskowitz, Kowall, Caday & Finklestein, 1994), and Yamada and colleagues (1991) have shown that administration

of FGF-2 prevented thalamic degradation after a cortical infarct. FGF-2 is expressed in subplate neurons in the adult brain only in response to injury (Gomez-Pinilla *et al.*, 1994).

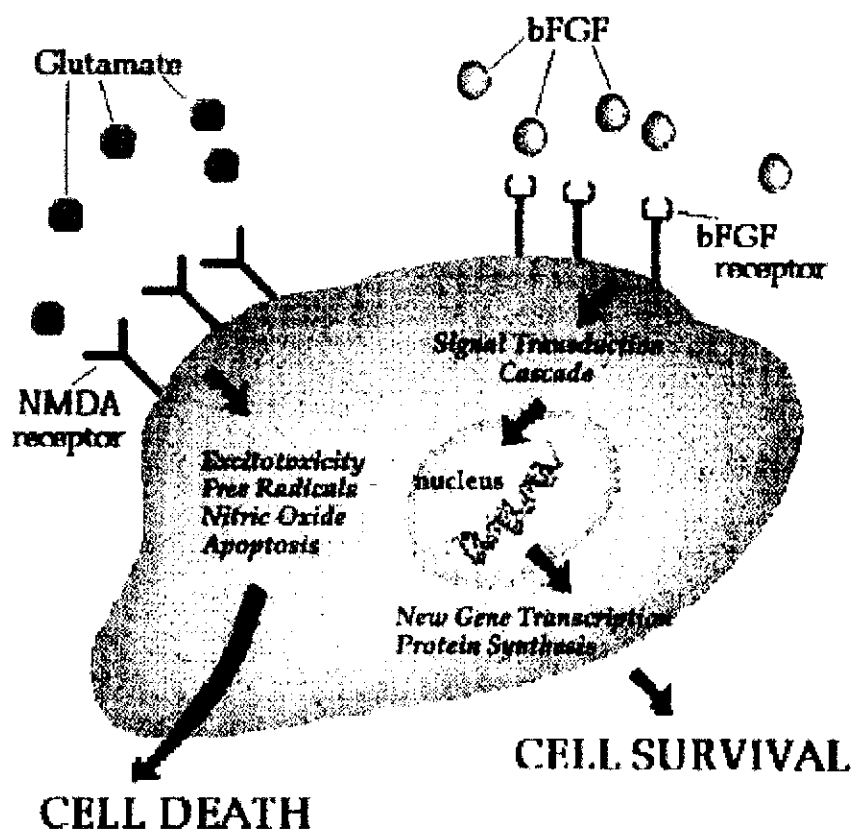

Figure 1-3. A proposed mechanism by which exogenous FGF-2 may initiate a signal transduction cascade that results in the expression of cytoprotective genes and proteins to aid in cell survival (From Lin *et al.*, 1997, p. 249).

Although the function of subplate neurons is of yet unknown, research by Ghosh and colleagues (1990) suggest that during development they may play a role in connectivity of thalamocortical neurons. Therefore, the re-expression of FGF-2 in subplate neurons in adulthood in response to injury suggests that there is a reinstatement of at least some

developmental events (Gomez-Pinilla *et al.*, 1994). Thus, understanding the role of FGF-2 during development helps to create a framework for understanding its role in adult plasticity.

1.4 CORTICAL DEVELOPMENT

The capacity for change in the CNS is regulated by the availability of effective forms of plastic mechanisms. Further, the form of plasticity available to the brain, whether it is regeneration or reorganization, is constricted by the presence of the underlying mechanisms that support it. These mechanisms will vary with the developmental stage of the CNS. Therefore, knowing when and where these mechanisms occur during development will help in understanding the potential for plasticity during different times (for review see Kolb, 1995;1999).

Cortical development occurs as sequential events (see Figure 1-4) that are replicated in all mammalian species and include neurogenesis, migration and differentiation (Kolb, 1995). During each one of these events a number of changes are occurring that demonstrate either high or low plasticity.

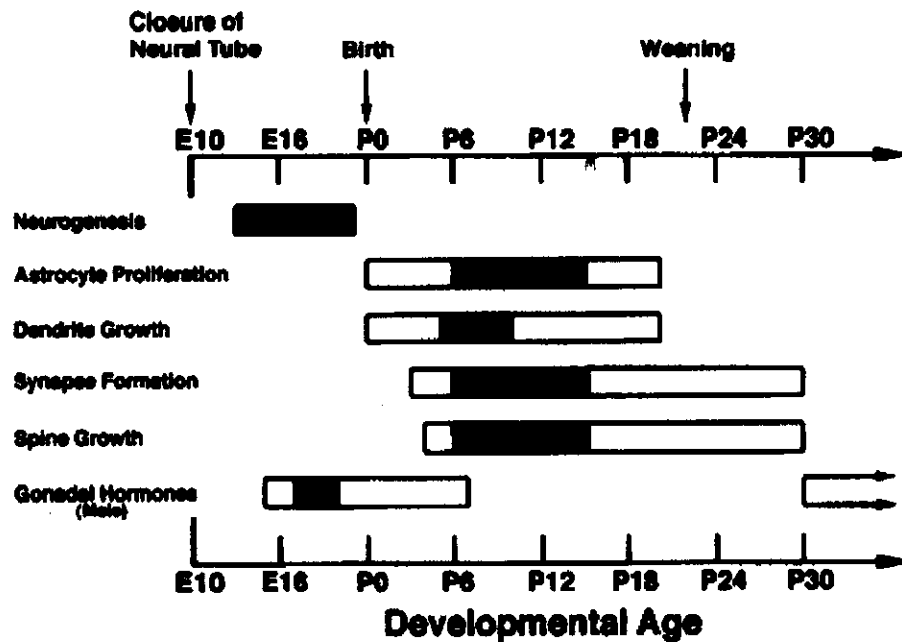

Figure 1-4. *Illustration of the stages and timing of the developing rat cortex (Kolb & Gibb, 2001)*

1.4.1 Neurogenesis

In the rat, neurogenesis begins at about embryonic day 12 (E12) and continues until E21 (Uylings, Eden, Parnavelas & Kalsbeek, 1990). The majority of cortical neurons originate in the neuroepithelium, also known as the germinal zone, which lines the lateral ventricles (Reid & Walsh, 1996). In the earliest stages of neurogenesis when the germinal cells are dividing and creating daughter cells, they move away from the ventricle wall and then return to repeat the process (Hicks & D'amato, 1961; Uylings *et al.*, 1990). At the onset of neurogenesis all daughter cells leaving the proliferating zone are mitotic (see Figure 1-5), but as neurogenesis proceeds an increasing portion of daughter cells that leave become mitotically dormant (Takahashi, Nowakowski & Caviness Jr., 1994).

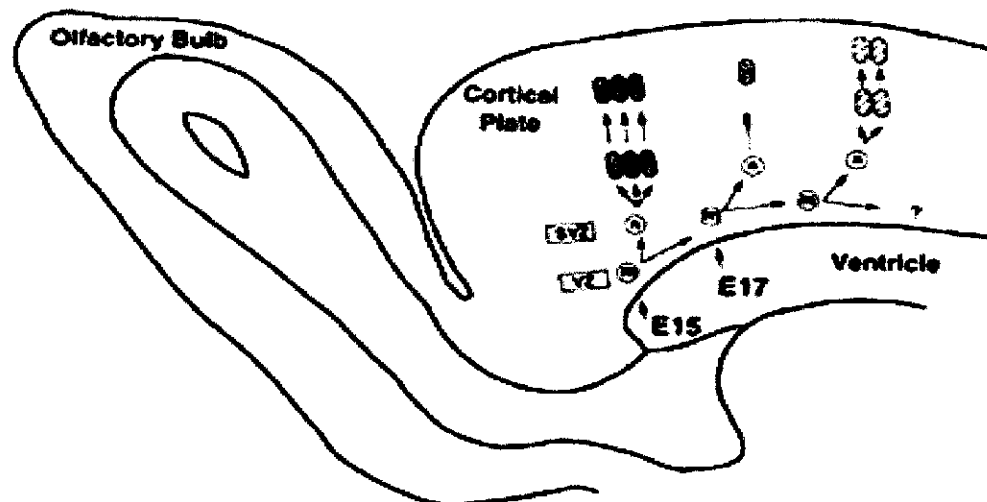

Figure 1-5. *A hypothetical model of cell lineage depicting a migrating multipotential \textcircled{m} cell as it divides, producing three non-migratory progenitor cells $\textcircled{\cdot}$. Each progenitor cell acts independently, dividing multiple times (shading), directly differentiating (stippling) or dividing once (cross-hatching). (From (Reid & Walsh, 1996)*

All the cells that form a particular layer of the cortex proliferate at the same time (Kolb & Whishaw, 1989). Layer VII (subplate) neurons are born between E14 – E16; layer VI neurons are born between E15 – E17; layer V neurons between E16 – E18; layer IV neurons between E17 – E19; and finally layers II – III neurons are born between E17 – E20 (Bayer & Altman, 1991).

The number of cortical neurons is determined by the number of neuronal progenitor cells, the rate of their proliferation, and the number of mitotic cycles that they undergo. The final size of the cortex will be determined by the number of cortical neurons (Vaccharino, 1999).

1.4.2 Migration

Cortical development progresses in an ‘inside-outside’ (radial) gradient in all cortical areas (Bayer & Altman, 1991). Once cells leave the proliferative zone they migrate radially (the majority) through the intermediate zone and then to the cortical plate. The oldest neurons form the deepest (subplate) layer and the youngest neurons make up the superficial layers (Reid & Walsh, 1996). An exception to this rule is layer I which is actually the top portion of the preplate. The preplate is the earliest cortical layer to be formed but subsequent neurons invade the preplate splitting it in two as they build upon it. The top layer of the preplate becomes the most superficial layer; layer I; and is located just under the pial and the bottom layer forms the subplate, Layer VII. In every layer there also exists a ‘transverse’ or lateral to medial gradient with older cells located most laterally and the younger cells making up the dorsomedial region. Further, an anterior to posterior gradient in every layer constitutes the longitudinal gradient.

Although the cells of each particular cortical layer migrate together (Kolb & Whishaw, 1989), there is about a one day delay between the frontal pole and the most posterior cortical region, the occipital lobe, in the radial gradient. The longitudinal gradient also shows a delay in cortical development of about one day so that anterior cells in layers VI – III have a peak time of origin that is about one day prior to posterior cells. Therefore in layer V, for example, neurogenesis peaks at E15 in the ventrolateral wall and at E17 in the dorsomedial (motor and cingulate) cortices.

A more detailed description of cortical development can be reviewed in *Neocortical Development* (Bayer & Altman, 1991) and *The Cerebral Cortex of the Rat* (Kolb & Tees, 1990).

1.4.3 Differentiation

Once neurons have migrated to their perspective layers and brain regions the process of differentiation occurs (Kolb & Whishaw, 1989). It is at this time that cells develop their adult characteristics, sending out processes and making connections that establishes the mature cortical organization. The cortex is organized into functional regions that in turn are organized into cortical (lamina) layers (Reid & Walsh, 1996). Neurons of distinct regions have afferent (incoming) and efferent (outgoing) connections that relate to their specific functions.

1.5 BRAIN INJURY AND RECOVERY

Consequences of cortical focal lesions follow a sequence of events. Aside from the obvious loss of neurons following aspiration, there is also a loss of intercortical connections. Cells situated on the edge of the lesion site (penumbra) are at the highest risk and many, if not all, will subsequently die. Lost connections are not restricted to neighboring neurons, however, as reciprocal connections to other cortical and subcortical regions are also lost. The loss of connectivity to remote regions results in retrograde damage. Retrograde damage can be either direct or indirect. Direct retrograde damage is a consequence of severed connections to the target cell(s) and the inability to make new connections. Indirect retrograde damage is the consequence of lost neurotrophic support that was once supplied by the aspirated area. So for example, a loss of the prefrontal cortex may disrupt posterior cortical neurotransmitter levels as many neurotransmitters enter the posterior cortex through a pathway that first passes through the frontal lobe (indirect) and as well, corticocortical connections would also be lost (direct).

Two factors that are related to functional outcome following brain injury are the age at which the injury occurs and the location of the injury (for review see Kolb, 1995). Both factors result in variable functional outcomes with deficits that range from mild to extreme. There is also an interaction between these two factors that will further affect outcome following injury. Therefore, an early injury in one brain area may result in good functional recovery, whereas an injury at the same age in another brain region will result in poor functional recovery. Differing functional outcomes are exemplified by the varying consequences of medial prefrontal (MFC) versus posterior parietal (PPC) cortical lesions in rats (Kolb & Gibb, 2001). Further, there are differences in the response to treatment following injury in these two regions.

1.5.1. Age of Injury

One of the first demonstrations that age was an important factor in relation to injury came from Kennard(1936) who reported that children were able to compensate for injury better than adults with a similar injury. In summary, the theory proposed that the earlier the injury, the better the outcome and was later termed the 'Kennard Principle'. Hebb (1949) was the first to reveal restrictions to the 'Kennard Principle', showing that, depending on the stage of development, early brain injury could actually result in a worse functional outcome than a similar injury in later life. He proposed that the immature brain must first develop representations or schemata before an injury in early life would have good functional outcome. If the injury occurred prior to this development, then the outcome would be worse than in later life. This claim has been reconfirmed in numerous studies of the frontal cortex in rats (Kolb *et al.*, 2001). An additional factor that was not

discussed by Kennard or Hebb, but recently proposed by Kolb (1995), is that not all brain regions follow the fundamental rules related to age and recovery.

1.5.2. Location of Injury

Both the MFC and PPC in the rat are involved in higher cognitive functioning (e.g., Kolb & Whishaw, 1990). Recently, research has shown that both the MFC and PPC of the rat can be dissociated into functional regions, however (Kolb, Buhrmann, McDonald & Sutherland, 1994). For example, the MFC is involved in remembering the configuration or relationship of spatial cues, whereas the PPC is involved in the guidance of the body through visual space. Further, parallels of each region are found in larger-brained mammals (Kolb, Nonneman & Singh, 1974; Kolb & Walkey, 1987), suggesting that similar consequences would result following injury in the human brain.

1.5.3 Bilateral Medial Frontal Cortical Injury and Age

Two very distinct deficits found following bilateral MFC lesions are impairments in acquisition of spatial tasks and a deficit in motor performance, with the latter essentially being restricted to tasks involving forelimb use. Extensive research on the effect of MFC lesions has shown differential functional recovery on these two tasks. Functional recovery from spatial deficits appears to be highly dependent on age at the time of injury, whereas functional recovery of motor deficits following injury at varying ages is enduring.

There are profound learning deficits in the MWT and impairments in short-term memory that are illustrated in tasks such as the radial arm maze (Kolb, Sutherland &

Whishaw, 1983). In contrast, neonatal MFC lesion-rats show greater functional sparing in the water task relative to adult operates (Kolb & Whishaw, 1985). In adulthood, bilateral MFC lesion rats show poor coordination in the manipulation of food, and difficulty ordering movements. Similarly, lesions in infancy also show difficulty with food manipulation and ordering movements in adulthood (Kolb, 1984). Yet, early injury alone does not allow for good functional recovery, as the outcome will vary with the developmental stage the injury occurs in.

In a series of experiments, Kolb and colleagues (Kolb, Gibb & Gorny, 2000) found that developmental stage was a predictor of functional outcome (see Figure 1-6).

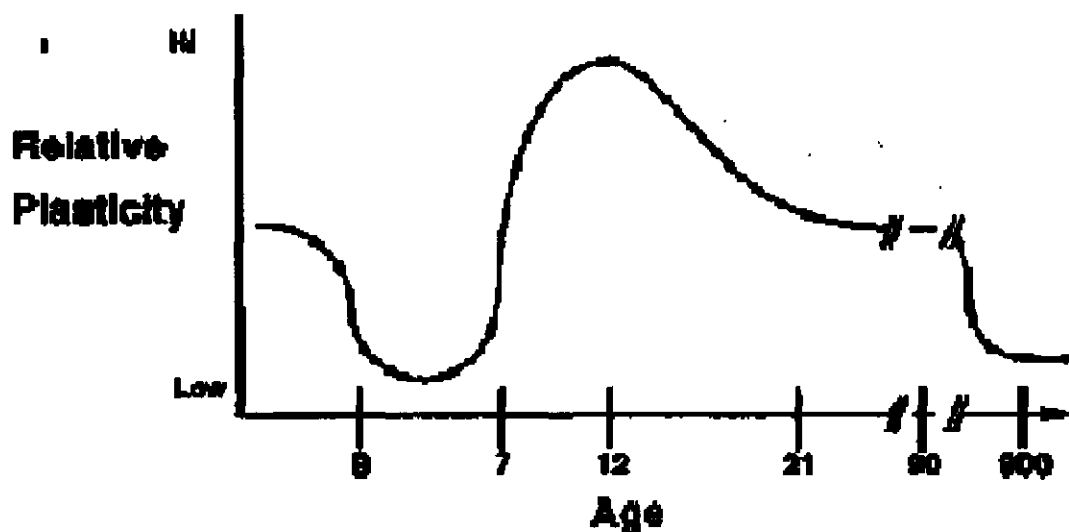

Figure 1-6. An illustration of the proposed degree of plasticity that is shown in rats following MFC lesions at different ages (From Kolb, 1999, p. 20).

. It was found that specific stages showed good functional recovery (e.g., E18; P10), whereas other stages of development showed poor recovery (e.g., P1; P5). Following

optimal recovery at about P12, there is a decrease in functional outcome with time that continues throughout life with lesions of the MFC in adulthood resulting in poor functional recovery. Anatomically, as adults, Subcortically rats with P7 lesions showed a decrease in brain surface dimension and weight, as well as a shrinkage of the anterior thalamus and a reduction in cortical thickness relative to controls and adult MFC operates (Kolb & Whishaw, 1981).

Changes in cell morphology such as dendritic branching are consistently found to be anatomical correlates of age-dependent functional recovery after MFC lesions (Kolb & Gibb, 1991;1993). Following MFC lesions, P10 rats showed the greatest increase in branching and the highest level of functional recovery, adult lesion rats also showed an increase in dendritic branching and some functional recovery, although to a lesser extent than the P10 rats. Finally, P1 lesion rats showed the least amount of dendritic branching and had poor functional recovery.

1.5.4. Bilateral Posterior Parietal Cortical Injury and Age

Bilateral lesions of the PPC create profound deficits in spatial navigation in rats. The impairment is related to movement of body through space and rats show little recovery in this task following the lesion (Kolb & Cioe, 1998; Kolb & Whishaw, 1985). Unlike humans or primates, however, there is little evidence of motor deficits (Calton, Dickinson & Synder, 2002; Chapman, Gavrilesco, Wang, Kean, Egan & Castiello, 2002; Kolb & Walkey, 1987). In tasks that require skilled reaching for example, PPC lesion rats are as proficient as controls. Although research of PPC lesions is not as extensive as that of MFC lesions, a review of the relationship between age and recovery reveals an

interesting phenomenon (Kolb & Cioe, 1998; Kolb, Holmes & Whishaw, 1987; Kolb & Walkey, 1987). In contrast to lesions of the MFC, PPC lesions show a linear relationship with age and functional recovery that is demonstrated in cognitive tasks, such as the Morris water task (see Figure 1-7). The earliest lesions show very poor functional recovery with a slow progression of improvement with age. Yet, even in adulthood PPC lesion animals do not show good functional outcome.

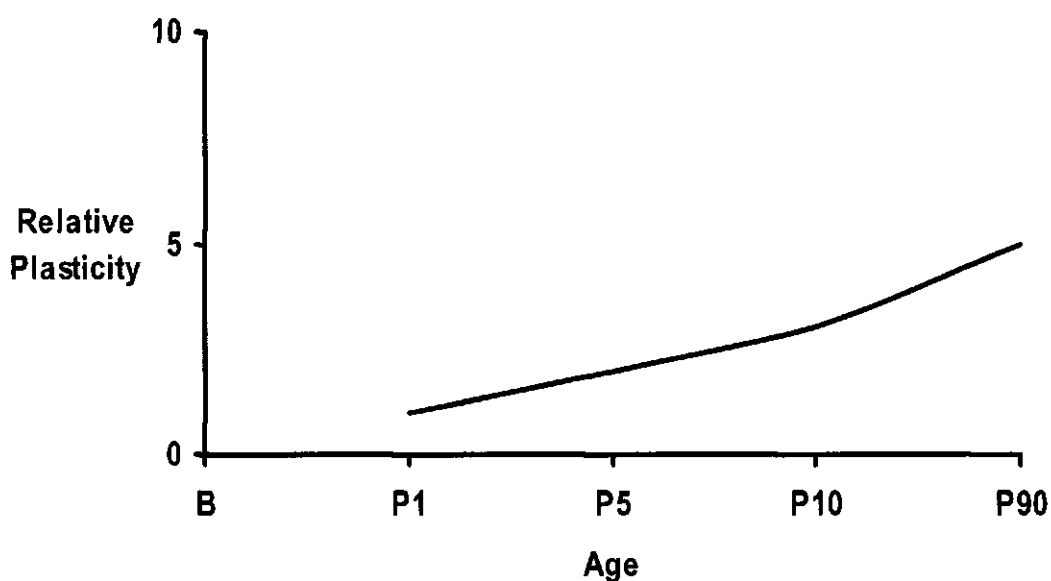

Figure 1-7. Abstract depiction of the level of functional recovery attained following PPC lesion at various postnatal days.

Studies have consistently shown that postnatal lesions incurred in the first week of life have dismal functional outcome, as do lesions at P10 (Kolb *et al.*, 1987). Adult PPC lesion rats also show enduring deficits in navigation (King & Corwin, 1992; Kolb *et al.*, 1987; Kolb & Whishaw, 1985), but these are minor with the exception of deficits in spatial reversal tasks (Kolb *et al.*, 1983). Further, Kolb and Whishaw (1985) have shown that neonates with lesions of the PPC exhibit deficits that are not typically found

following adult PPC lesions. The neonates showed novel deficits in species specific behavior, such as food hoarding and grooming sequence.

A gross inspection of brains following PPC lesions in rats showed that the hippocampus was distorted, but still intact (Kolb & Whishaw, 1985). Subcortically, the dorsal thalamus was severely shrunken and the anterior part of the lateral posterior (LP) thalamic nucleus was absent with the posterior part consisting of mainly glial with sparse neurons. Anatomical correlates of the variability in functional recovery following PPC lesions at different ages to date have left some unanswered questions.

The gross inspection of the lesion cavities in adulthood showed only minor dimpling in most neonate lesion rats, whereas distinct cavities persisted in adult operates (Kolb & Cioe, 1998; Kolb & Whishaw, 1985). Yet, the neonates showed significantly lighter brain weights than the adult operates. Furthermore, Kolb and colleagues (1987) have found that the earlier the lesion the thinner the cortex, with the majority of the cortical reduction occurring in adulthood rather than immediately following surgery. In a similar study, Kolb and Cioe (1998) examined cell morphology and reported a decrease in dendritic branching in both P10 and P5 PPC lesion rats as adults. As well, P5 rats had a decreased length of apical and basilar branches, whereas the P10 rats had a decrease in length of the apical but not basilar branches. Spine density was also analyzed, revealing a decrease in both the P5 and P10 rats.

An interesting observation made by Kolb and Cioe (1998) was that following neonate PPC lesions at P5 or P10 the lateral ventricles in every brain were open. As astrocytes are being produced in the VZ inside the lateral ventricle, this could affect astrocytic production and account for poor dendritic growth and poor functional outcome.

1.5.5. Previous Treatment Strategies Used Following P3 MFC and PPC Lesions

A number of treatment strategies have been studied following MFC lesions in rats, and to a lesser extent the PPC. A review, although not complete, of some of these studies is presented below.

Tactile stimulation Tactile stimulation has shown remarkable improvement in behavioral functional recovery following both MFC lesions at P3, PPC lesions at P4, and entorhinal cortex lesions at P4 (Gibb & Kolb, unpublished). A decrease in cortical atrophy relative to the untreated PPC lesion suggests a correlation between structural changes and functional recovery.

Enriched environments Anatomical effects of enriched environments include an increase in cortical thickness (Kolb & Elliot, 1987) and are correlated with improvement in functional outcome following early cortical lesions. Although much of the findings are related to studies on the frontal cortex, preliminary work by Kolb and Gibb (unpublished) have shown an improvement in functional recovery following PPC lesions as well.

FGF-2 Rats that received post-surgery injections of FGF-2 following P3 bilateral MFC lesions showed substantial functional recovery (Kolb et al., 2000). Furthermore, results of western blot analysis following either P3 or P10 MFC lesions have shown a decrease in FGF-2 immunoreactivity in P3 lesion rats and increased immunoreactivity in P10 lesion rats that is also correlated with an improvement in behavioral functional outcome (Gibb, Burton, Day, & Kolb, 2001).

1.6 SUMMARY

The previous sections reviewed the brain's capacity for change, mediating neurochemical factors, the events that occur during development, and differential effects of cortical lesions, all of which lead to developing a better understanding of potential plasticity in the injured brain.

During embryonic development neurogenesis is an important factor in recovery. Once neurogenesis is complete, compensation must come from changes in existing neurons (Kolb & Whishaw, 1989), or the rescue of compromised but surviving neurons. Although changes in dendritic morphology have been correlated with functional recovery, it is also apparent that these mechanisms of plasticity have a limited effect (Kolb *et al.*, 2001).

The age at the time of injury is a mediating factor in behavioral functional recovery. Recovery will also be influenced by the brain region that is injured. An especially vulnerable period for brain injury, irrespective of the location of brain injury, however, appears to be within the first few days of life. The vulnerable period suggests that there is some characteristic of this developmental period that is undermining recovery. One suggestion is that the decreased level of FGF-2 available during this time makes it difficult for the brain to initiate the repair processes that occur following injury after the first week of life.

FGF-2, a neurotrophic factor that has been proposed to promote neurogenesis and gliogenesis, as well as acting as a supportive mechanism in the rescue of compromised neurons, shows promise in enhancing functional recovery following injury. Preliminary research has shown benefits of FGF-2 in enhancing functional recovery following P3

MFC lesions, but to date similar research does not exist for the effects of FGF-2 following P3 PPC lesions.

1.7 RESEARCH APPROACH

The preceding review has shown that cortical location and age are mediating factors in behavioral functional recovery following focal cortical lesions. As well, FGF-2 has been shown to be a multifunctional neurotrophic mechanism that may benefit recovery from early brain injury. Therefore, the present research was designed to examine the role of FGF-2 in enhancing functional recovery following P3 MFC or PPC lesions.

Previous research has shown that subcutaneous administration of FGF-2 following P3 MFC lesions may be beneficial in enhancing functional recovery but it has not been examined following PPC lesions. Therefore, Experiment 1 was designed to repeat the earlier, unpublished study, as well as to examine whether or not P3 PPC lesion rats would also benefit from the treatment.

It was later suggested that due to the unstable nature of proteins such as FGF-2, the storage conditions used in Experiment 1 may have caused changes in biological activity. Therefore, Experiment 2 was conducted to re-examine the effects of FGF-2 when the protein was mixed daily rather than premixed. Similar behavioral and anatomical methods used in Experiment 1 were repeated in Experiment 2.

Previous work by Vaccarino and colleagues (1999) showed an increase in neuronal numbers following prenatal treatment of FGF-2. There were no behavioral tests performed however, so the functional benefits of such treatment were not known. It was

hypothesized that an increase in neuronal numbers would be beneficial following early cortical lesions, as it may provide additional neurons to compensate for neuronal loss following focal lesions. Therefore, Experiment 3 was designed to examine the potential for prenatal FGF-2 in the enhancement of behavioral function following P3 MFC or PPC lesions.

The results of these experiments will enhance the understanding of (a) differential effects of early cortical injury in different brain regions, (b) how the brain may be compensating for these injuries, (c) whether neurotrophic factors are required for optimal functional recovery, and (d) whether enhancing neuronal numbers prior to insult will enhance behavioral functional recovery. These findings may have implications for treatment strategy following brain injury in humans. The research could provide evidence for the benefits of increasing the availability of neurotrophic factors in these patients. Furthermore, the research could provide a clue as to a preventive strategy that could enhance recovery should an injury occur later in life.

1.8 BEHAVIORAL AND ANATOMICAL MEASURES OF PLASTICITY

In the present set of experiments, both behavioral and anatomical measures were used to examine the effects of FGF-2 on recovery after either MFC or PPC lesions at P3. The behavioral measures were used to analyze functional outcome. An examination of anatomical observations and measures were used to aid in the determination of anatomical correlates of behavioral outcome. In the section that follows, a review of each of these tests and measurements, as well as the rationale for use, will be given.

Body Weight

In rats, lesions in early life have been shown to have little effect on overall body weight. The addition of exogenous FGF-2 may however, produce lighter body weights as has been shown in previous studies with P3 MFC rats. Therefore, body weights were recorded at the time of perfusion and used for analysis.

Brain Weight

Brain weight is a useful measurement of cell loss. A substantial loss of tissue would be reflected in brain weight. If treatment is able to decrease this loss, it should then be reflected in heavier brain weights relative to untreated counterparts. As well, it provides a measurement for the degree of tissue loss following either MFC or PPC lesions. It may be that there is greater retrograde damage following PPC lesions, as well, which may explain their poor functional outcome.

Cortical thickness

There are two ways that dendritic loss may be measured. One way is through Golgi techniques that stain a random number of neurons that can then be visually observed and drawn, thus establishing the number of dendritic branches, the length of branches and the spine density. Another technique is to take gross measures of cortical thickness. Much of the cortex is taken up by dendritic branches (Uylings *et al.*, 1990) and any substantial loss would be reflected in measurements of cortical thickness.

Lesions in almost any cortical region will result in a thinning of the remaining cortex. An interesting phenomenon is that the reduction in cortical thickness is usually

limited to areas that are caudal to the lesion. As the MFC is anterior to PPC lesions, we would suspect that the planes representative of the anterior cortex would have cortical thickness comparable to controls after PPC lesions. If treatment increased neuronal numbers, dendritic branching, or axonal outgrowth, we would expect an increase in cortical thickness relative to the untreated lesion rats.

Cortical surface area (SA)

Cortical surface area (SA), as measured by dorsal brain area, is an alternative measure to brain weight. Although cortical SA and brain weight are correlated, cortical SA provides a measurement that excludes the cerebellum. As the cerebellum may be inadvertently affected by disruptions in cortical connectivity following early cortical lesions, the cortical SA provided a measurement that reflected cortical loss alone, in contrast to brain weight measures.

Lesion surface area (SA)

Measurements of lesion SA were used to determine the extent of visible cortical lesion in MFC animals. FGF-2 has been proposed as a mechanism in neuron rescue in the penumbra following lesions. Therefore, an analysis of lesion size would provide a means to measure whether or not this occurred in the current experiments. PPC lesions were excluded from this analysis as these lesions are often barely visible on the surface due to the collapse of surrounding cortex into the lesion cavity.

Thalamus and brain stem cross-sectional dimensions

Cortical regions can be dissociated by their thalamic connections. A major thalamic input to the medial frontal cortical area, for example, is the medial dorsal thalamic nuclei (MD). Therefore, it would be predicted that MFC lesions would produce atrophy in the anterior sections of the thalamus. The MFC also has direct connections to the spinal cord which pass through the brain stem. In cases where corticospinal connections are lost, atrophy of the brain stem has been reported.

The PPC has reciprocal connections to both the dorsal lateral (DL) and the lateral posterior (LP) thalamic nuclei. Lesions of the PPC trigger a degeneration of both nuclei, with no visible deterioration of the LGN. As well, P3 lesions cause a disruption in the organization of the cells in LP nuclei, and at times, the LD nuclei.

Following either MFC or PPC lesions, atrophy of the respective thalamic nuclei can be analyzed using measurements of thalamic dimensions at a point where the nuclei are present. Any treatment benefits to retrograde damage should result in a reduction in the shrinkage of the perspective thalamic and brain stem dimensions.

Morris Water Task

In humans, Milner (1965) suggested that a deficit in mastering mazes following frontal injury was due to perseveration and impulsivity, rather than spatial deficits per se. Deficits in spatial tasks, such as the Morris Water task (MWT), are commonly found occurrence in rats. The deficit however, is due to very specific aspects of the task, such as strategy. In rats, Kolb et al.(1994), reported the impairment in acquiring the MWT appeared to be due to the use of inefficient strategies, rather than an actual spatial deficit.

The finding supported an earlier study by Sutherland and colleagues (1985), that reported deficits owing to acquisition and not retention, as animals that had been pretrained in the task prior to injury did not show the same degree of deficit.

Lesions of the PPC also result in behavioral deficits related to spatial task (Kolb & Walkey, 1987). More specifically, they appear to be involved in the use of distal cues, as an examination of swim path showed that the PPC rat learned the general location of the platform but had difficulty with the heading in the place task version of the Morris water task in which the platform is stationary. In contrast, the rats were unable to learn the landmark task in which the platform is moved randomly but retains a constant relationship with a specific cue (landmark) and thus requires an association between a contiguous cue and the platform. This suggests that there was a problem in extracting the relevant visual cues from the irrelevant ones. This is a different deficit than found in MFC lesion rats as they are impaired at the acquisition rather than movement through space.

Whishaw Tray Reaching Task

In reaching the deficit found following MFC lesions appears to be related to the inability to pronate the elbow to align the extended paw with the food (Whishaw, Pellis & Gorny, 1992). Therefore, behavioral functional sparing as a consequence of spared corticospinal connectivity would be reflected by an improvement in performance on a skilled-reaching task.

Bilateral PPC lesions in rats do not result in motor deficits, with the exception of body posture (Kolb *et al.*, 1994). This is different than in primates, which show deficits in

movement of limbs in visual space. The difference may lie in the use of different sensory modalities. The primate relies on visual information to guide hand movement through space, whereas the rat relies on olfactory information to guide forelimb movement (Whishaw & Tomie, 1989).

2. *Experiment 1: Effects of Postnatal FGF-2 following P3 MFC and PPC cortical lesions*

ABSTRACT

Bilateral lesions of the medial prefrontal cortex (MFC) or posterior parietal cortex (PPC), as well as sham lesions, were performed at postnatal day 3 (P3). Beginning 24 hours post-surgery, subcutaneous injections of FGF-2 were administered for seven consecutive days or no intervention until adolescence. At P60, activity level was recorded and followed by a cognitive task (spatial navigation) and a motor task (skilled reaching). Once behaviour testing was completed, animals were sacrificed and the brains prepared for analysis of gross anatomical measures. Both the MFC and PPC lesion rats were impaired at spatial navigation, whereas only the MFC lesion rats showed a deficit in skilled reaching. FGF-2 treatment had a differential effect on both lesion site and task. Treated MFC-lesion rats showed a slight improvement in spatial navigation but no improvement in skilled reaching. In contrast, treated PPC-lesion rats showed no improvement on behaviour tasks. Results of anatomical measures showed no effect of FGF-2 on cortical thickness or thalamic cross sectional area. These findings suggest that FGF-2 may have cortical area and behavioral task dependent effects on recovery of function.

2.1 INTRODUCTION

Rats with medial prefrontal cortical (MFC) lesions between postnatal day 7 (P7) and P10 show almost complete recovery that is correlated with an increase in dendritic spines relative to controls (Kolb & Gibb, 1993), and regrowth of lost tissue (Kolb, Gibb, Gorny & Whishaw, 1998) . In contrast, rats with lesions on days P1-5 have a poor functional outcome and no cortical regrowth (Kolb, 1995). What is not known are the mechanisms behind the spontaneous recovery and regeneration in the P10 but not P1-5 rats. It has been proposed however, that brain injury at P7-10, but not P1-5, induces endogenous release and synthesis of a number of neurotrophic factors, including growth factors that are crucial for the support and survival of neurons. Of particular interest is basic fibroblast growth factor (FGF-2). Not only is FGF-2 instrumental in neuronal survival, there is evidence that FGF-2 is involved in the rescue of neurons following injury as well (Catapano, Arnold, Perez & Macklis, 2001; Chadi & Fuxe, 1998; Mattson & Cheng, 1993). Yet, endogenous FGF-2 is at a minimal until the second week of life when cortical astrocytes, the chief manufacturer of FGF-2, reach peak production (Gomez-Pinilla, Lee & Cotman, 1994). This suggests that endogenous FGF-2 may play a role in the spontaneous recovery following P10 MFC lesions.

Another perplexing issue is that the relatively favorable outcome following P10 MFC injury is not equal across brain regions, suggesting that factors influencing recovery are also influenced by the location of injury. For example, posterior parietal cortical (PPC) lesions at any time during the first two weeks of life result in devastating and enduring deficits, with the earlier lesions, P1-5, showing greater deficits than P10 lesions

(Kolb & Cioe, 1998; Kolb & Whishaw, 1985). The reason for the relative advantage of MFC versus PPC lesions is unknown.

Based on the evidence of FGF-2 involvement in neuronal survival and differentiation, and the absence of this growth factor during developmental times that show poor functional recovery, it was hypothesized that FGF-2 may be at least partially responsible for the spontaneous recovery after P10 MFC lesions. Further, the poor functional outcome of PPC lesion rats and the limited research data to date warrants further investigation into possible treatment strategies. Therefore, the purpose of the following experiments was to determine if exogenous application of basic fibroblast growth factor (FGF-2) after P3 MFC or PPC lesions would influence functional recovery.

2.2 MATERIALS AND METHODS

2.2.1. Subjects

Seventy Charles River Long-Evans pups (33 M, 37 F) were used in both the behavioral and anatomical studies. The pups were grouped in a two-stage process. In the first stage, pups in each litter were randomly assigned to receive one of three lesions at P3: [1] sham (C) lesions (12 M, 14 F), [2] medial frontal cortical (MFC) lesions (12 M, 11 F), and [3] posterior parietal cortical (PPC) lesions (9 M, 12 F). In the second stage, litters were assigned to one of two treatment groups: [1] no-treatment (NT) and [2] postnatal FGF-2 (FGF-2). Five pups (4 MFC; 1 PPC) were later deleted owing to lesions that invaded other cortical areas.

The combined treatments produced six groups. These six groups were then used for two experiments. Experiment 1.1 included 4 groups: [1] NT sham, [2] NT MFC, [3] FGF-2 sham, [4] FGF-2 MFC. Experiment 1.2 also included 4 groups: [1] NT sham, [2] NT PPC, [3] FGF-2 sham, [4] FGF-2 PPC. An additional seven animals (4 M, 3 F) were added to the control group for use in behavioral testing alone.

All pups were housed with dams in clear plexi-glass hanging tubs on a 12 hr light/dark schedule until they were weaned. After weaning, young rats were housed in litter-mate, same-sex groups of 2-3. Ad-lib food and water was available throughout the behavioral testing period, except for a period of food deprivation during the Whishaw reaching task. Behavioral testing began when pups were about 60 days old. Following behavior testing, animals were sacrificed and brains were prepared for anatomical analysis.

2.2.2. Surgical Procedures

On postnatal-day 3 (P3), pups were anesthetized via hypothermia in a ThermoTrom cooling apparatus. Surgery began when rectal temperatures reached approximately 18° - 20°C and the pups were immobilized. The overlying skull above the intended cortical lesion was removed with iris scissors. The target cortex was removed with gentle aspiration and the incision was sutured with sterile silk thread. Pups were slowly warmed to normal body temperature and returned to their dams. Aside from the actual lesion site, the above procedures were repeated for both the MFC and PPC lesions. For the sham controls, the skin overlying the skull was incised and then sutured as with the lesion groups.

Posterior Parietal Cortical (PPC) lesions

For those pups receiving PPC lesions, the region roughly analogous to Kreig's area 7, the skull was removed slightly anterior to where the PPC is located in adulthood (Kolb & Walkey, 1987). Adjusting for continued posterior brain development, an area of the brain covered by the middle third of the skull between bregma and lambda was determined to be the appropriate location of the PPC (Kolb & Cioe, 1998).

Medial Prefrontal Cortical (MFC) lesions

MFC lesions were performed by removing the frontal bone and aspirating the cortex anterior to bregma that included Zilles' (1985) areas Cg1, Cg3, PL and the medial portion of the Fr2.

2.2.3. Injections

On post-operative Day-1, pups were removed from the home cage and taken to a small testing room. Subcutaneous injections of FGF-2 were administered between the shoulder blades of the pups for seven consecutive days. The dosage was weight-dependent, with each pup receiving 0.01cc/gm of body. Pups were weighed every other day and the dosage was adjusted accordingly. Pups were returned to dams immediately after each injection session.

2.2.4. Histology

At the conclusion of behavioral testing, animals were given an overdose of sodium pentobarbital and intracardially perfused with 0.9% saline solution followed by 4% paraformaldehyde. The brains were removed and stored in a 30% sucrose in 4% paraformaldehyde post-fixative. About three weeks following perfusion the brains were removed from the post-fixative, frozen, and cut at 40 μ m on the cryostat. Every 10th section was saved and mounted on coated-slides. Sections were left to air dry and stained with Cresyl violet.

2.2.5. Anatomical Measurements

Measurements of body weight, brain weight, cerebellum surface area (SA), cortical thickness, dorsal cortical surface area (SA), dorsal lesion surface area (SA), and anterior and posterior dorsal thalamic cross sectional area were taken for anatomical comparisons between groups.

Cortical thickness

In the present study, cortical thickness was obtained from five specific cortical planes (see Figure 2-1). Plane 1 was identified by the first anterior section containing the striatum, Plane 2 by the appearance of the anterior commissure, Plane 3 by the bilateral appearance of the anterior hippocampus, Plane 4 by the visibility of the posterior commissure, and Plane 5 was identified by the last section that included the posterior hippocampus.

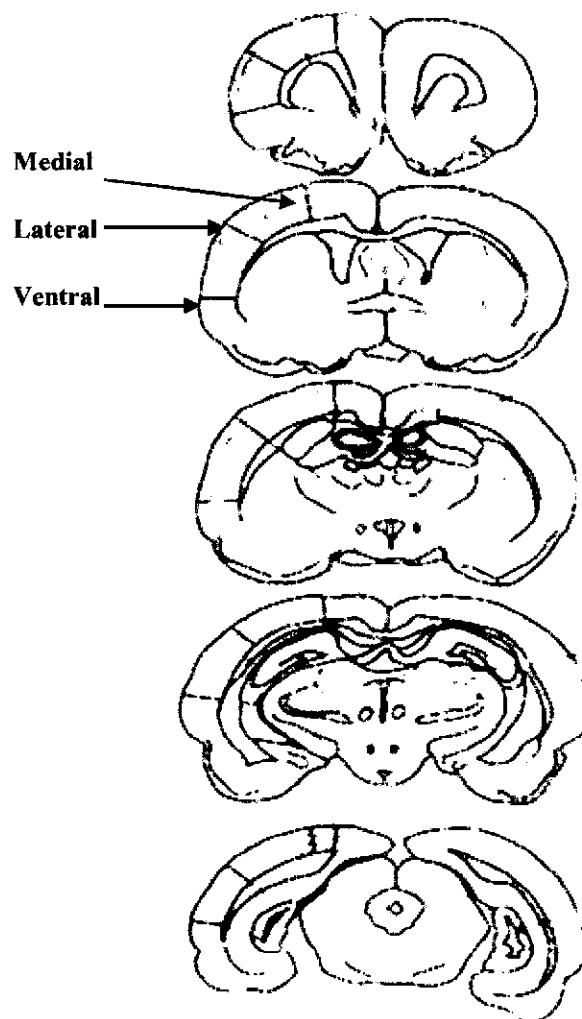

Figure 2-1. Coronal sections through normal brain showing the three locations where measurements were taken on each of five planes to calculate cortical thickness.

Bilateral measurements were taken at three different locations for each cortical plane described (see Figure 2-1.). The first location represented the midline or medial cortex, the second location represented the lateral cortex, while the third location represented the ventral-lateral cortex. As the lesions were bilateral, an average cortical thickness of both hemispheres was used for analysis. When a group(s) was missing the portion of cortex being measured (as occurred on the first plane of all medial-frontal lesion groups) they were excluded from the analysis of the location/plane.

Cerebellum, Cortical, and Lesion SA

Photographs of the brains prior to sectioning were transferred to NIH Image and measurements were taken of the dorsal cerebellum and cortical SA (see Figure 2-2a.). Estimates were made in cases where the anterior cortex was missing following MFC lesions (see Figure 2-2b.). The lesion SA was also recorded and the percentage of cortex lost as a result of the lesion was calculated.

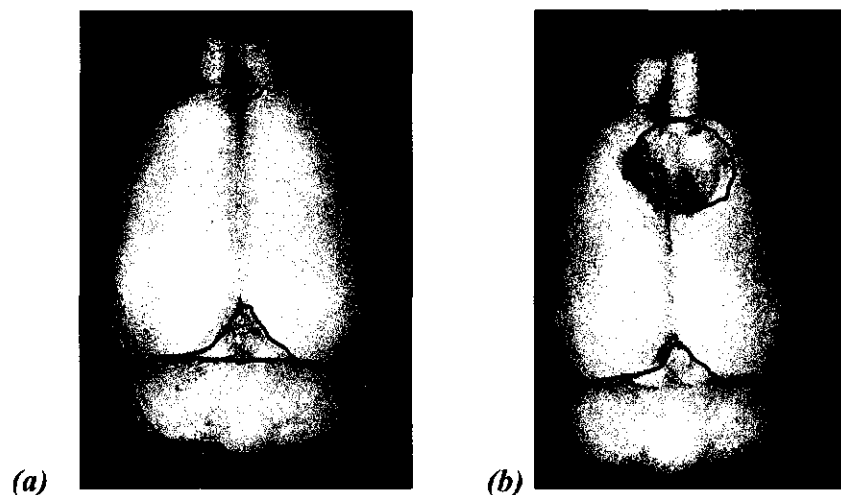

Figure 2-2. *Photographs of brains from a control (a) and a medial frontal (b) rat. Areas outlined in red were used for cortical SA and lesion SA.*

Anterior and Posterior Thalamic Cross-sectional Areas

The cross-sectional area of the diencephalon was measured at the level of the dorsal medial nucleus (MD) of the thalamus (Figure 2-3a) and the lateral geniculate nucleus (Figure 2-3b). Photographs of the respective sections were taken at a constant magnification and transferred to NIH Image. The thalamic area was measured at a constant enlargement and the area calculated in mm.

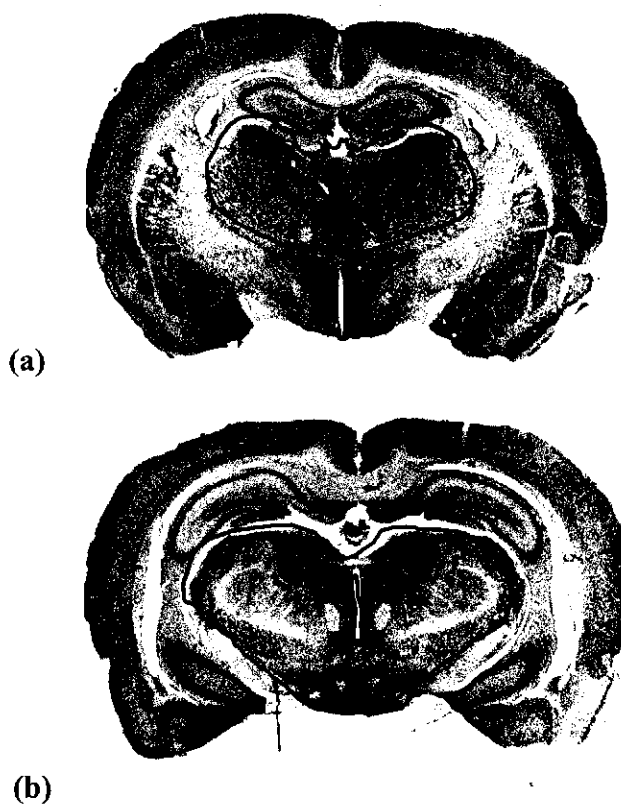

Figure 2-3 *Coronal sections of a normal brain showing the thalamic area that was measured, as identified by the outlined segments of each figure.*

2.2.6. Behavioural Procedures

Morris Water Task

Animals were tested using the standard *place task* version of the Morris Water Task. The pool measured 1.5 meters across and 45 cm high. A number of distal visual cues were located around the room and no attempt was made to screen them from view (see Figure 2-4). The pool water was made opaque with ~1200ml of milk powder with a temperature of 18 – 20 degrees. A round platform with a 12 cm diameter and measuring 30 cm high was placed in the pool about 2cm beneath the water surface.

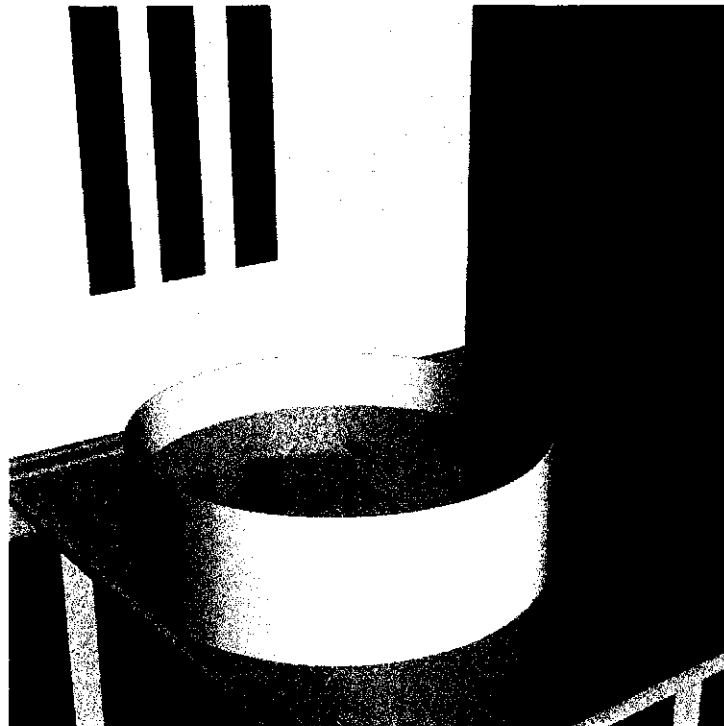

Figure 2-4 *A cartoon of the Morris Water Maze pool setup, and the type of cues present in the room.*

To begin the test, the experimenter placed the animal into the water with its nose facing the pool wall. The rat was released and the timer started. Each rat was allowed to search for the platform for a maximum of 90 sec. The time required to find the platform

was recorded, as was the swim path. When the animal found the platform it was allowed to remain there for another 10 seconds and then was removed by the experimenter. If the rat did not find the platform within 90 sec., the rat was guided to the location and also allowed to stay on the platform for 10 sec. before being removed from the pool. Each animal received four trials per day, starting from a different location each time. The testing ran for seven consecutive days. On the eighth day a single probe trial was conducted. During the probe trial the platform was removed and once placed in the pool, the animal was allowed to search for 60 sec. before being removed.

Whishaw Tray Reaching Task

Rats were food deprived and maintained at 85% of their normal weight, adjusted for continued growth. Food deprivation consisted of removing ad lib food bins from the home cages and limiting food consumption to about 15 grams/day per rat.

Testing cages measured 30.5cm high by 20.5 cm wide by 28.0 cm in length. The sides and back of the cage were made of clear plexi-glass, thin metal bars formed the front of the cage, and the bottom was made of wire mesh (see Figure 2-5). Food trays ran the length of the cage front with about 5cm between the tray and the cage. The spacing between the tray and cage allowed the rats to reach and retrieve food pellets that were placed on the tray, but prevented the rat from simply 'dragging' the pellets into the cage.

For the first three days, rats were placed in the reaching cages in groups for one hour. For the following seven consecutive days, rats were individually caged and allowed to retrieve and consume pellets for half an hour/day. By the 10th day the animals had learned the task and controls were proficient at food retrieval. On the 11th day each

animal was video taped for five minutes. The number of attempts and successes in reaching for, and obtaining food pellets was later scored. A reaching attempt was scored each time the fore-paw was extended through the bars and an attempt was made to grasp the pellets. When the attempt resulted in the successful retrieval and consumption of a food pellet, a success was recorded. The percentage of successes over attempts was calculated.

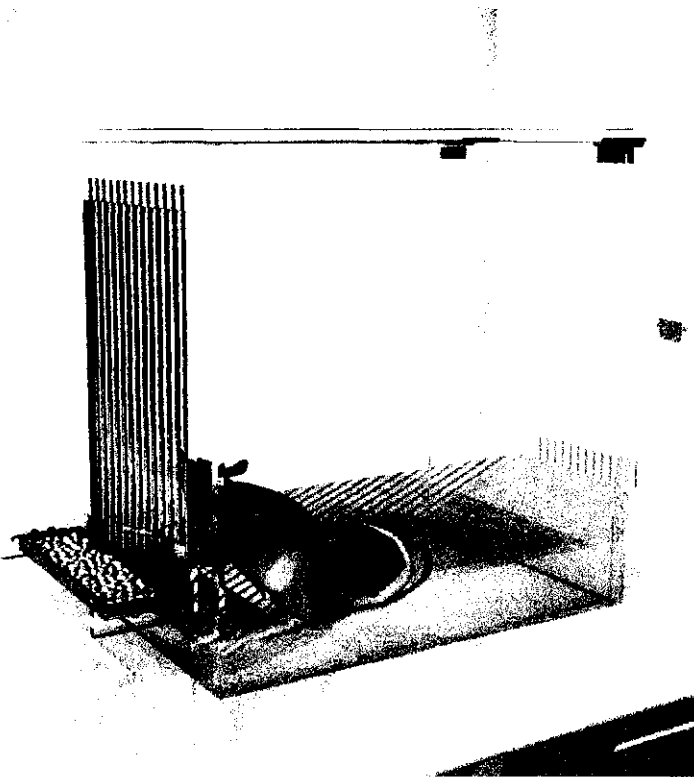

Figure 2-5 *Cartoon of the cage used in the Whishaw Tray Reaching task.*

Open Field Testing

Individual activity in a novel environment was measured for a 10 minute period using a Digiscan apparatus. The digiscan is a clear plexi-glass box that measures 30.5cm high by 41 cm wide by 41cm long that monitors and records movement. Animals were removed from their home cages and transported to a behaviour testing room where they were individually placed in the digiscan box for 10 minutes. At the end of the 10 minutes the animal was removed and returned to the holding cage.

2.2.10. Statistical Methods

Analyses of variance were used for all statistical measures except where homogeneity of variance was violated. In these cases a Mann Whitney-U or Students *t*-test was used. *Post hoc* evaluations were conducted with Fisher's LSD ($P < 0.05$) unless the results were unexpected, and thus truly post hoc, in which case the more conservative Tukey's HSD ($P < 0.05$) was performed.

2.3 RESULTS

Experiment 1.1 Medial Prefrontal Cortical Lesions

2.3.1. ANATOMICAL RESULTS

2.3.1.1. Body Weight

Male and female rats with MFC lesions had a reduced body weight relative to the NT Controls. As well, male rats that had received FGF-2, with or without a lesion, had a reduced body weight compared to the NT groups. The body weight of female rats did not differ between treatment groups.

An ANOVA with lesion, treatment, and sex as variables revealed a main effect of treatment, $F(1,36) = 8.51, p = 0.006$, (NT > FGF-2), a main effect of lesion, $F(1, 36) = 4.68, p = 0.037$, (Controls > MFC), and a main effect of sex, $F(1, 36) = 239.61, p \leq 0.000$. No interactions were found (p 's > 0.05). Only the FGF-2 MFC males showed a significant reduction in body weight compared to NT Control males ($p = 0.018$).

Table 2-1. Summary of body weights for sexes and collapsed totals.

Body Weights (g)			
Group	Male	Female	All
NT Control	554 ± 21	336 ± 18	435 ± 36
FGF-2 Control	521 ± 12	321 ± 7	407 ± 28
NT MFC	525 ± 47	336 ± 23	417 ± 44
FGF-2 MFC	465 ± 13*	298 ± 10	395 ± 26

* significantly different than NT Controls at ≤ 0.05

2.3.1.2. Brain Weight

Overall, rats with MFC lesions had lighter brains than controls, whether or not they received FGF-2 treatment (see Table 2-2). An ANOVA with group, treatment, and sex as variables showed a main effect of lesion, $F(1, 37) = 47.54, p \leq 0.000$, and sex, $F(1, 37) = 8.82, p = 0.005$, but no main effect of treatment, $F(1, 37) = 1.83, p = 0.185$. There were no interactions (p 's > 0.10).

Table 2-2. Summary of brain weights for sexes and the collapsed means.

Group	Brain Weights (g)		
	Male	Female	All
NT Control	1.71 ± 0.04	1.63 ± 0.04	1.67 ± 0.03
FGF-2 Control	1.70 ± 0.04	1.60 ± 0.02	1.64 ± 0.02
NT MFC	1.53 ± 0.07*	1.50 ± 0.04*	1.52 ± 0.02**
FGF-2 MFC	1.50 ± 0.03**	1.43 ± 0.03**	1.48 ± 0.02**

* significantly different than NT Controls at ≤ 0.05

** significantly different than NT Controls at ≤ 0.001

2.3.1.3. Cerebellum SA

As a sex difference was found, analyses of cerebellum SA were performed separately for each sex. Both males and females showed no overall effect of treatment or lesion, although female lesion rats treated with FGF-2 had a larger cerebellum SA relative to untreated control females (see Table 2-3). ANOVA's showed no main effect of lesion for males, $F(3,18) = 0.846, p = 0.486$, nor for females, $F(3,19) = 2.068, p = 0.138$. Fisher's post hoc analyses showed, however, that the cerebellum SA of FGF-2 treated MFC

females was significantly higher than that of the untreated sham lesion females ($p = 0.034$). There were no other significant differences among either the male or female groups (p 's > 0.100).

Table 2-3. Summary of mean cerebellum SA for each sex and combined.

Cerebellum SA (pixels²)			
Group	Males	Females	All
NT Control	433 ± 6	420 ± 2	427 ± 3
FGF-2 Control	444 ± 3	425 ± 5	433 ± 4
NT MFC	436 ± 7	432 ± 3	434 ± 3
FGF-2 MFC	435 ± 4	435 ± 4*	435 ± 3

* significantly different from NT controls at $p = 0.05$

2.3.1.4. Cortical SA

An analysis of dorsal cortical SA showed that rats with MFC lesions had the expected reduction in cortex due to the loss of anterior cortex and the absence of any visible regrowth of tissue (see Figure 2-1). In contrast, the FGF-2 treated animals showed a slight increase in cortical SA, whether or not they had received a lesion.

An ANOVA with lesion and treatment as variables showed a main effect of lesion, $F(1,41) = 14.96$, $p = 0.000$, but no main effect of treatment, $F(1,41) = 1.646$, $p = 0.207$, nor the interaction, $F(1,41) = 0.035$, $p = 0.853$. A Tukey's LSD revealed that the untreated MFC-lesion rats had a significant reduction in cortical SA ($p = 0.012$), whereas the MFC rats treated with FGF-2 had only a marginal reduction ($p = 0.058$) relative to controls. Both the FGF-2 MFC lesion and the FGF-2 Control rats, however, did not

significantly differ from their no-treatment counterparts on measurements of cortical SA (0.395 & 0.346, respectively).

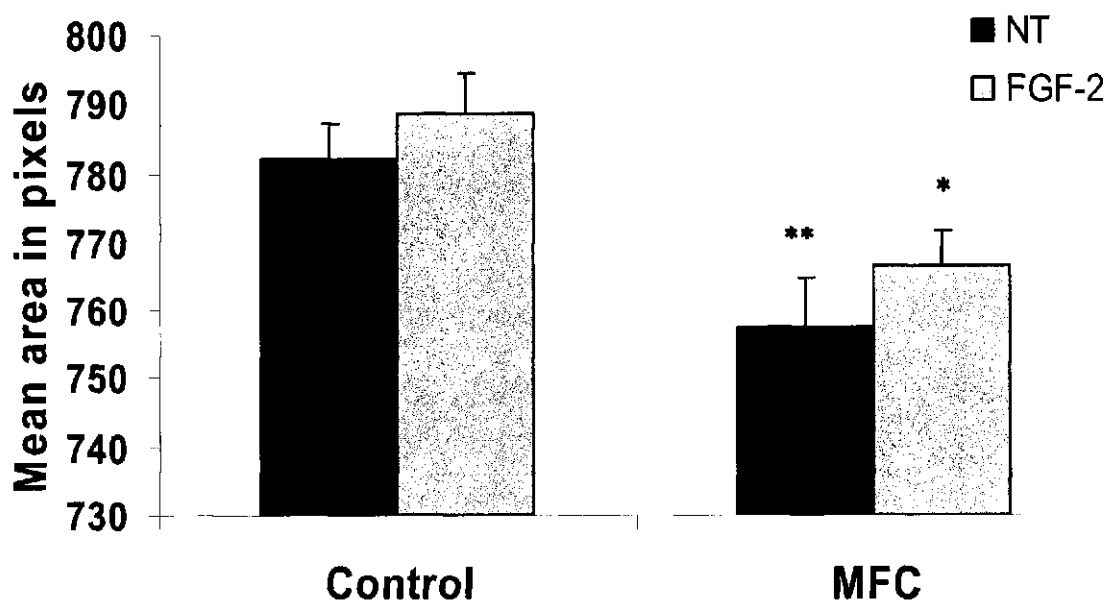

* significantly different than NT Controls at $p \leq 0.05$
 ** significantly different than NT Controls at $p \leq 0.001$

Figure 2-1 Mean cortical surface area measured in pixels²

2.3.1.5. Lesion SA

About 15 percent of the dorsal cortical surface area was lost following MFC lesions in the FGF-2 treated group whereas, only about 10 percent was lost in the MFC lesion group that did not receive treatment. The loss of cortex was compounded by an estimated reduction in overall cortical surface area in animals with MFC lesions relative to controls.

A Student's *t*-test of lesion size for NT and FGF-2 MFC groups was significant, $t(17) = 6.1, p = 0.024$. An ANOVA of cortical SA for the MFC and control groups with lesion and treatment as variables showed a main effect of lesion, $F(1,41) = 14.88, p =$

0.000, with MFC lesion animals having a smaller dorsal area than the controls. There was no main effect of treatment, $F(1,41) = 1.65, p = 0.206$, and no interaction, $F(1,41) = 0.03, p = 0.876$. It should be noted that the above measurements represent dorsal surface area only and do not take into account the depth of the lesion.

2.3.1.6. Cortical Thickness

Owing to the loss of the anterior medial cortex in rats with MFC lesions, no analyses were performed for Plane 1 and Plane 2. In the remaining three planes, MFC lesions produced a thinner cortex on only Plane 3, whereas the addition of FGF-2 treatment and lesion produced a thinner cortical mantle on all three planes relative to controls. A Repeated Measures ANOVA with lesion and treatment as variables showed a main effect of lesion, $F(1,40) = 24.167, p = 0.000$, and treatment, $F(1,40) = 6.793, p = 0.013$, but not the interaction, $F(1,40) = 1.468, p = 0.233$. The lateral cortex, however, showed a decrease in cortical thickness following MFC lesions, irrespective of treatment. FGF-2 did appear to have a negative impact on controls in the anterior planes. Similarly, the ventral cortex was thinner in animals that had received MFC lesions and the effect was not reduced by FGF-2 treatment.

A Repeated Measures ANOVA of **medial cortex** on three planes with lesion and treatment as variables showed a main effect of lesion, $F(1,40) = 24.167, p = 0.000$, and treatment, $F(1,40) = 6.793, p = 0.013$, but not the interaction, $F(1,40) = 1.468, p = 0.233$. A Fisher's LSD revealed that both the treated and untreated MFC rats had significantly thinner on Plane 3 ($p = 0.000$ & $p = 0.003$, respectively), but only the FGF-2 treated lesion rats had a significantly thinner medial cortex relative to controls on Plane 4 and 5

($p = 0.001$ & $p = 0.037$, respectively). On Plane 4 the decreased cortical thickness in FGF-2 lesion rats was significant relative to the untreated MFC lesion rats as well ($p = 0.027$). There were no other significant differences among the groups (p 's > 0.05).

A Repeated Measures ANOVA of **lateral cortex** on five planes showed a main effect of lesion, $F(1,38) = 31.70$, $p = 0.000$, but not treatment, $F(1,38) = 1.637$, $p = 0.208$, nor interaction, $F(1,38) = 0.377$, $p = 0.543$. A Fisher's LSD showed that the NT MFC had thinner lateral cortices relative to controls on all planes except Plane 4 ($p = 0.000$, $p = 0.005$, $p = 0.000$, $p = 0.597$, & $p = 0.060$), as did the FGF-2 MFC rats ($p = 0.000$, $p = 0.000$, $p = 0.000$, $p = 0.238$, & $p = 0.005$). An interesting finding was that the FGF-2 controls also had a thinner lateral cortex, but only on Plane 3 ($p = 0.023$). There were no other significant differences among the groups (p 's > 0.05).

A Repeated Measures ANOVA of the **ventral cortex** on five planes showed a main effect of lesion, $F(1,39) = 17.579$, $p = 0.000$, but no main effect of treatment, $F(1,39) = 1.201$, $p = 0.280$, nor an interaction, $F(1,39) = 0.138$, $p = 0.713$. The untreated MFC lesion rats had significantly thinner cortices on Planes 2, 4 and 5, a marginally significant thinner cortex on Plane 1, and no significant difference in cortical thickness on Plane 3 relative to controls ($p = 0.073$, $p = 0.048$, $p = 0.161$, $p = 0.049$, & $p = 0.004$). Similarly, FGF-2 MFC lesion rats had a significantly thinner lateral cortex relative to controls on Planes 1-2, Planes 4-5, but not Plane 3 ($p = 0.003$, $p = 0.032$, $p = 0.103$, $p = 0.021$, & $p = 0.000$).

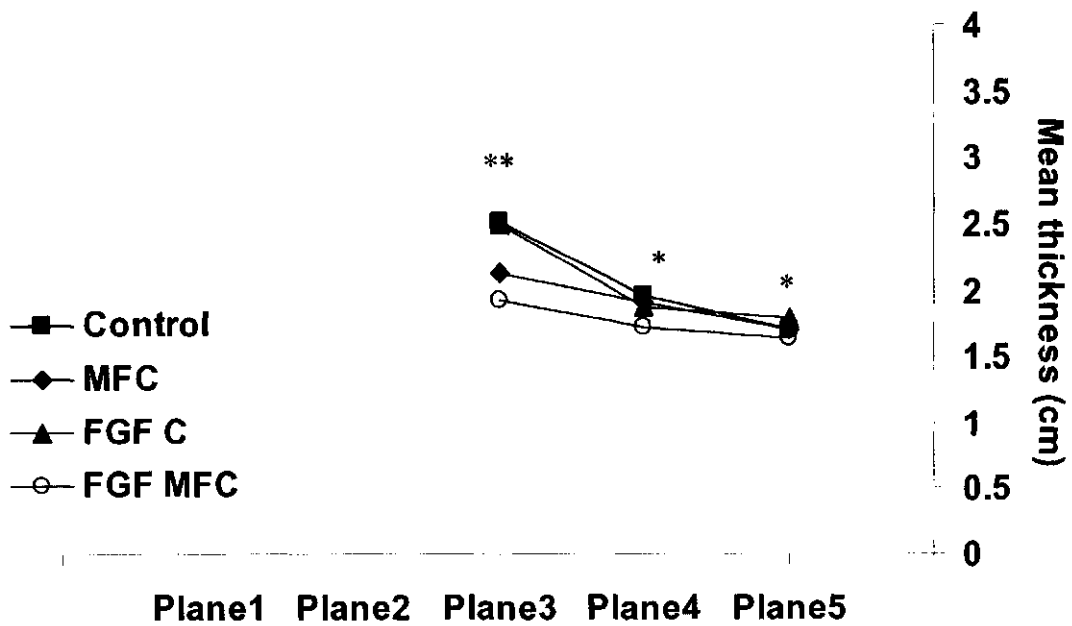

(a) Medial Cortex

- * significant difference between MFC lesion rats and controls
- * significant difference between FGF-2 MFC lesion rats and controls

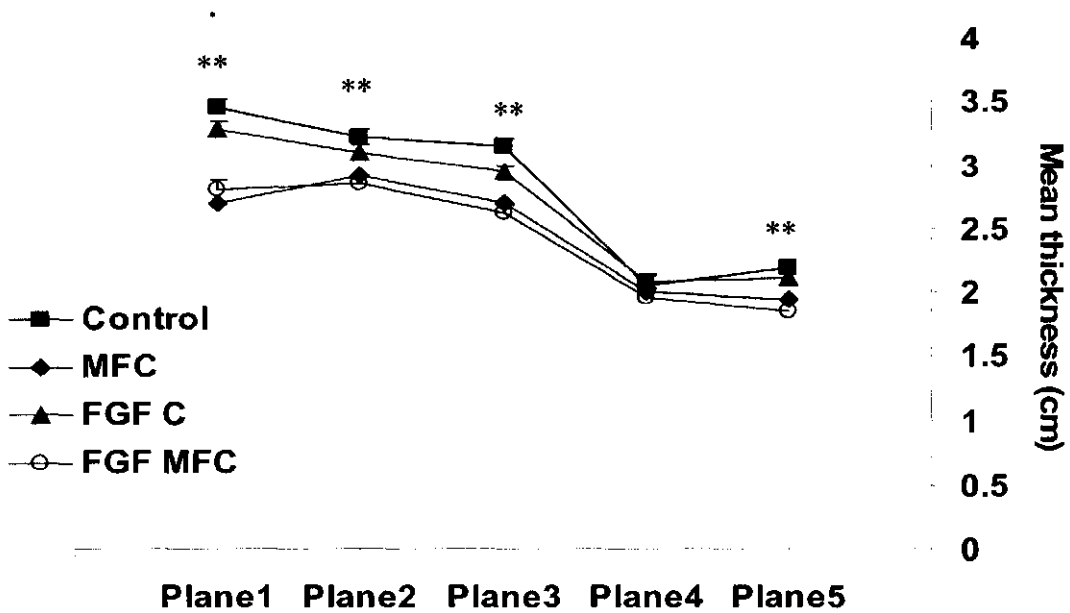

(b) Lateral Cortex

- * significant difference between MFC lesion rats and controls
- * significant difference between FGF-2 MFC lesion rats and controls

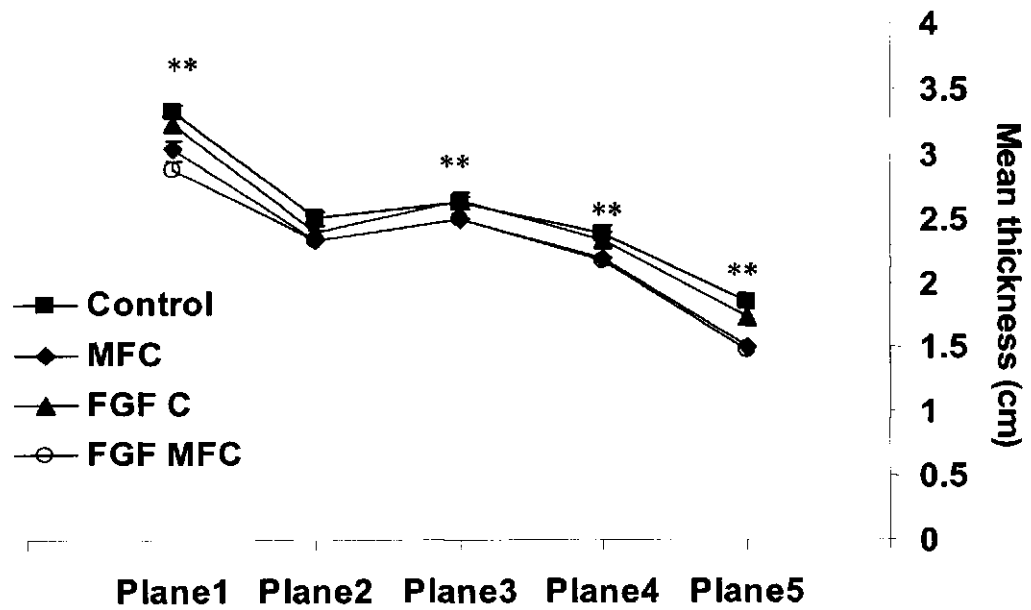

(c) *Ventral Cortex*

- * significant difference between MFC lesion rats and controls
- * significant difference between FGF-2 MFC lesion rats and controls

Figure 2-2 Summary of average cortical thickness of each plane measured at three locations: (a) medial, (b) lateral, and (c) ventral-lateral (ventral).

2.3.1.7. Anterior and Posterior Thalamic Sections

There was an overall reduction in cross-sectional measurements of both the anterior and posterior thalamus cross-sectional area in lesion animals relative to controls (see Table 2-4). An ANOVA of anterior thalamic cross-sections with group and treatment as variables, found a main effect of lesion, $F(1,40) = 78.56, p \leq 0.000$, but not treatment, $F(1,40) = 1.63, p = 0.210$, nor an interaction, $F(1,40) = 0.15, p = 0.71$.

Table 2-4 Mean measurements of cross-sectional area of the anterior thalamus and brain stem.

Thalamic Cross-sectional measurements (mm ²)		
Group	Anterior	Posterior
NT Controls	18.77 ± 1.39	31.88 ± 1.98
FGF-2 Controls	18.45 ± .850	31.24 ± 2.08
NT MFC	15.77 ± 1.67*	29.68 ± 2.41*
FGF-2 MFC	15.18 ± .733*	29.23 ± 2.09*

* significantly different from controls at $p \leq 0.05$

Similarly, an ANOVA of posterior thalamus cross-sectional area showed a main effect of lesion, $F(1,41) = 10.51, p = 0.002$, but not of treatment, $F(1,41) = 0.70, p = 0.41$, nor the interaction, $F(1,41) = 0.02, p = 0.88$, suggesting that exogenous FGF-2 was not able to rescue thalamocortical connections.

2.3.2. BEHAVIOURAL RESULTS

2.3.2.1. Morris Water Task

MFC lesions produced a deficit in the place task version of the MWM relative to controls. The rats were able to acquire the task but adopted a strategy that was less efficient than that of control animals (see Figure 2-3). The controls were able to swim a relatively straight path to the hidden platform, whereas rats with MFC lesions adopted a ‘looping’ strategy in which they typically pass the platform before altering their swim path to the correct location.

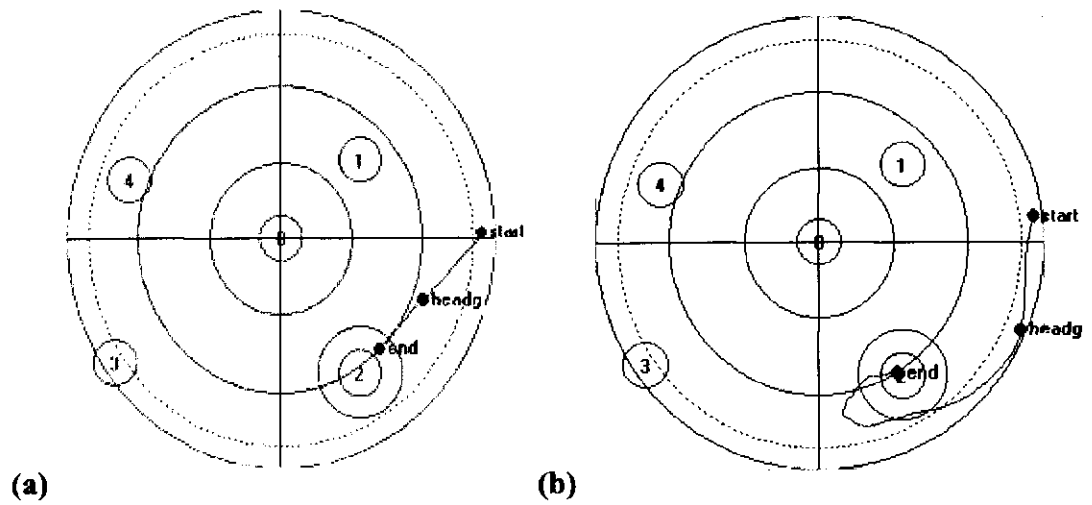
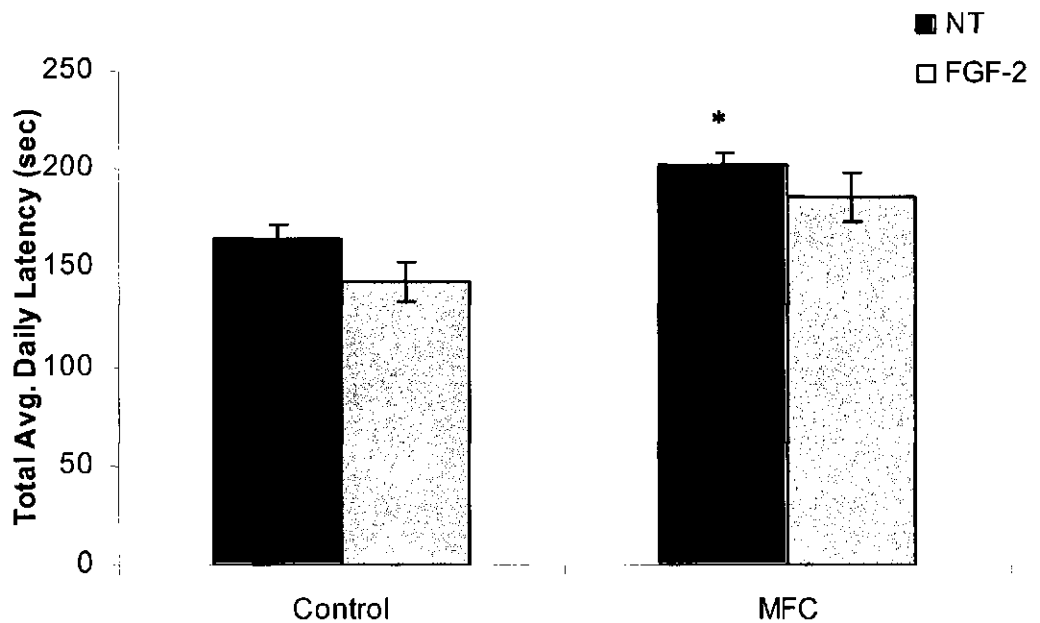

Figure 2-3 Representative swim path of rats with (a) sham lesion and (b) medial frontal lesion.

Rats with MFC lesions that were treated with FGF-2 were somewhat better at the task as they did not differ from untreated controls (see Figure 2-4).



* significantly different from controls at $p \leq 0.05$

Figure 2-4. Sum of mean latencies over seven trial blocks.

Owing to large variances in the task, One-way ANOVA's were used to analyze the MFC groups separately. Analysis of the NT MFC rats showed a significant main effect of lesion, $F(2,37) = 7.51, p = 0.002$. The lesion animals were impaired at the task relative to both the NT Controls ($p = 0.013$) and FGF-2 Controls ($p = 0.000$). Similarly, a One-way ANOVA of FGF-2 MFC lesion rats showed a significant main effect of lesion, $F(2, 42) = 4.139, p = 0.023$. There was no significant difference between the FGF-2 MFC group relative to NT Controls ($p = 0.12$). Rather, the lesion effect was due to the significant difference between the FGF-2 Control group and the FGF-2 MFC group ($p = 0.006$).

A Fisher's LSD of a Repeated Measures of daily mean latencies showed that the deficit in water maze performance in untreated MFC rats relative to controls was due to a delay in acquiring the task as the deficit was only apparent on the first two days (see Figure 2-5) and no significant difference in performance on the remaining trail blocks ($p = 0.044, p = 0.010, p = 0.937, p = 0.867, p = 0.490, p = 0.447, p = 0.977$, respectively). FGF-2 treated lesion rats showed a more modest delay in learning with a significant deficit in time to locate the platform on the first day only ($p = 0.044, p = 0.010, p = 0.937, p = 0.867, p = 0.490, p = 0.447, p = 0.977$, respectively).

The difference in average latency may have been due, in part, to variations in swim speed (see Figure 2-6). A One-way ANOVA showed a main effect of group, $F(3,45) = 6.07, p = 0.001$. A Fisher's LSD, however, showed that FGF-2 controls were significantly faster than untreated controls ($p = 0.006$), but only a marginally significant difference in speed between untreated MFC lesion rats and controls ($p = 0.052$), and no difference between FGF-2 lesion rats relative to controls ($p = 0.292$).

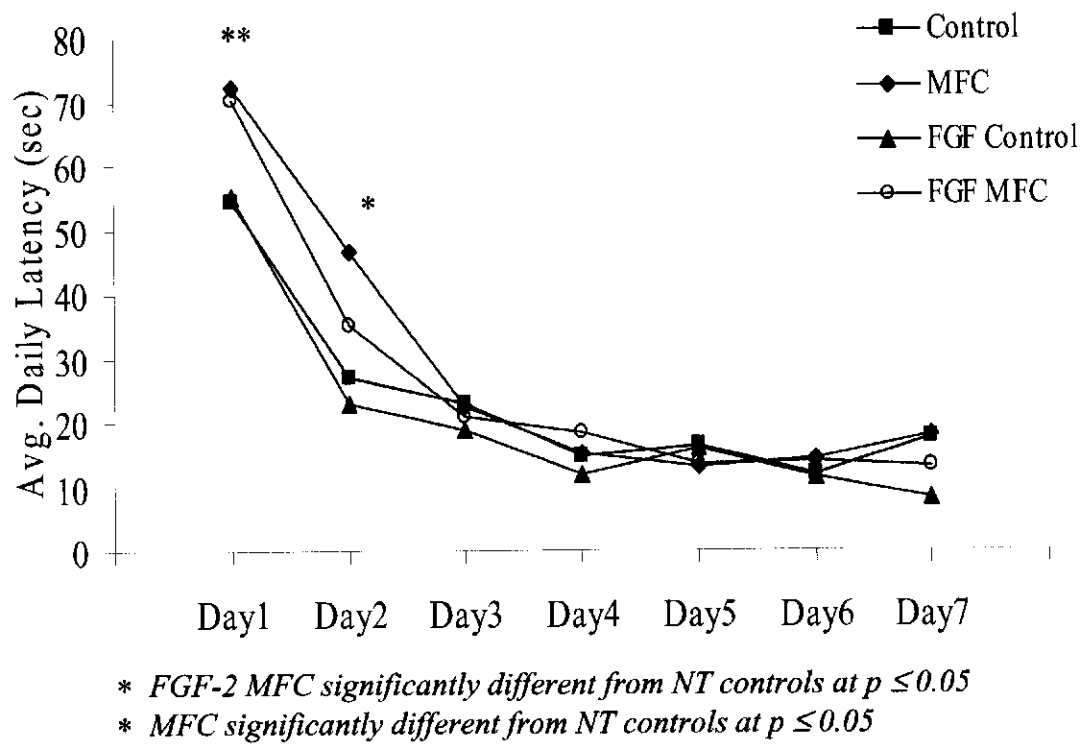

Figure 2-5 Mean daily latencies

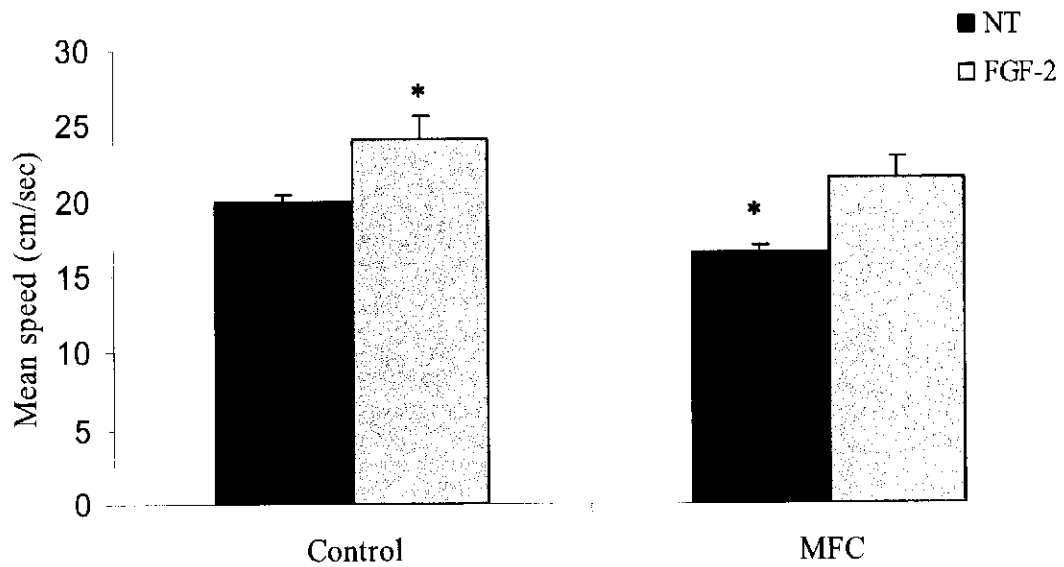
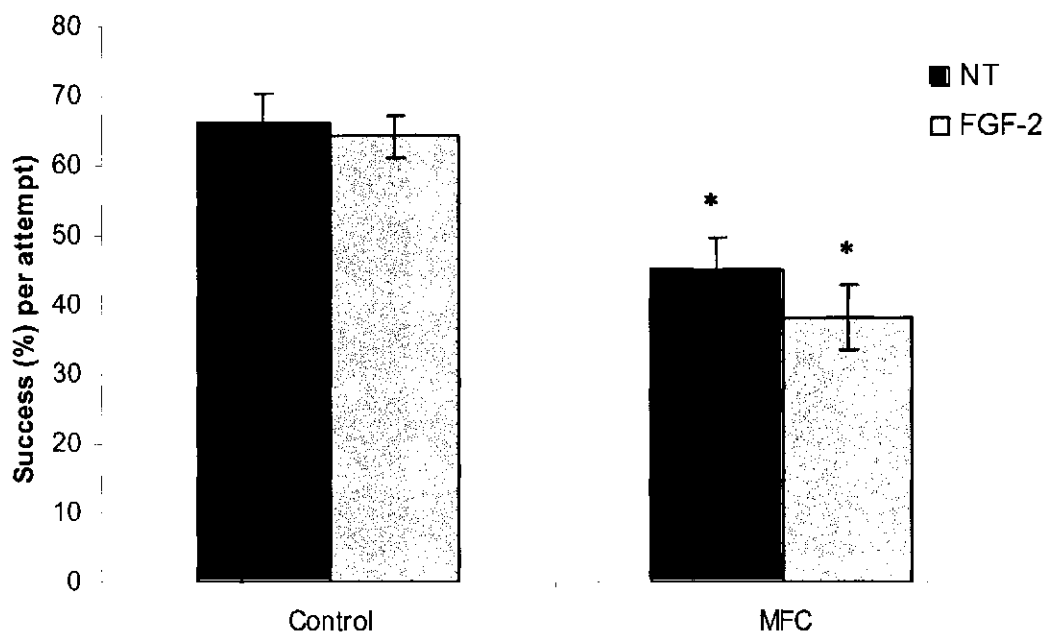

Figure 2-6 Mean swim speeds

2.3.2.2. *Whishaw Tray Reaching*

Overall, control rats had an average reaching success of about 65%. Animals with MFC lesions were impaired at the task. The no treatment MFC group achieved only a 45% reaching success, whereas FGF-2 treated animals with MFC lesions performed slightly worse at 38% reaching success (see Figure 2-7). An ANOVA revealed a main effect of lesion, $F(1,41) = 29.45$, $p = 0.000$, no main effect of treatment, $F(1,41) = 1.021$, $p = 0.318$, and no interaction, $F(1,41) = 0.35$, $p = 0.559$. Thus, MFC lesion animals were impaired, whether or not they had received FGF-2.



* significantly different from controls at $p \leq 0.05$

Figure 2-7 Mean percentage of reaching attempts that were successful.

2.3.3.3. Open Field Task

Rats with early lesions of the MFC showed an overall activity level comparative to that of the controls, whether or not they were treated with FGF-2 (see Table 2-5). Owing to a high variance in both NT groups, Mann Whitney-U tests were used to analyze each MFC group separately. The NT MFC rats did not differ in activity level relative to controls, $p = 0.837$, nor was there any difference in the overall activity of the FGF-2 MFC group when compared to controls, $p = 0.413$.

Table 2-5. Mean distance, horizontal, vertical, and number of movements.

Group	Treatment	
	NT	FGF-2
Control	428.30 ± 36.30	472.10 ± 13.98
MFC	449.35 ± 46.62	475.97 ± 23.90

2.3.3. ANATOMICAL RESULTS

Experiment 1.2 Posterior Parietal Cortical Lesions

2.3.3.1. Body Weight

The mean body weight of rats with posterior parietal cortical (PPC) lesions was comparative to that of controls. Overall, however, rats with FGF-2 treatment had a reduced mean body weight when compared to mean body weight of the no treatment groups (see Table 2-6). An ANOVA with lesion, treatment, and sex as variables showed a main effect of treatment $F(1,38) = 6.04$, $p = 0.019$, a main effect of sex, $F(1,38) = 246.51$, $p \leq 0.000$, but no main effect of lesion, $F(1,38) = 0.117$, $p = 0.734$, nor the interactions (p 's > 0.10).

Table 2-6 Mean body weight for sex and group and the combined weigh.

Body Weights (g)			
Group	Male	Female	All
NT Control	554.00 ± 21.5	336.17 ± 18.2	435.18 ± 36.76
FGF-2 Control	521.50 ± 12.1	321.50 ± 07.6	407.21 ± 28.20*
NT PPC	548.33 ± 30.5	363.60 ± 18.6	464.36 ± 34.09
FGF-2 PPC	465.00 ± 07.4	333.83 ± 7.39	402.00 ± 28.28*

* significantly different from NT groups at $p \leq 0.05$

2.3.3.2. Brain Weight

Rats with posterior parietal lesions had significantly lighter brain weights in adulthood than the sham lesion controls, irrespective of treatment (see Table 2-7). This finding was consistent across sexes.

Table 2-7 Summary of mean brain weights.

Brain Weights (g)			
Group	Male	Female	All
NT Control	1.71 ± 0.04	1.63 ± 0.04	1.67 ± 0.029
FGF-2 Control	1.70 ± 0.04	1.60 ± 0.02	1.64 ± 0.024
NT PPC	1.55 ± 0.03*	1.49 ± 0.03*	1.52 ± 0.020**
FGF-2 PPC	1.50 ± 0.03**	1.46 ± 0.04*	1.48 ± 0.026**

* significantly different than NT Controls at $p \leq 0.05$

** significantly different than NT Controls at $p \leq 0.001$

An ANOVA with lesion, treatment, and sex showed a main effect of sex, $F(1,39) = 8.25, p = 0.007$, a main effect of lesion, $F(1,39) = 45.75, p = 0.000$, but no main effect of treatment, and no interactions (p 's > 0.10). A Fisher's LSD test showed that PPC lesion animals in both the NT and FGF-2 treatment groups had significantly lighter brains when compared to the Control group (p 's ≤ 0.000).

2.3.3.3. Cerebellum SA

Both male and female rats with PPC lesions showed an increase in cerebellum size relative to controls that was further enhanced by treatment of FGF-2 in lesion rats (see Table 2-8). ANOVA's showed no main effect of lesion in the males, $F(3,18) = 2.69, p = 0.077$, whereas a main effect of lesion was found for females, $F(3,21) = 10.79, p = 0.000$. A Fisher's LSD tests showed that untreated and treated male rats with lesions had significantly larger cerebellums relative to same-sex controls ($p = 0.026$ & $p = 0.027$, respectively). Similar results were shown in the female groups, with treated and untreated female lesion rats having significantly larger cerebellums relative to female controls ($p = 0.003$ & $p = 0.000$, respectively).

Table 2-8. Summary of mean cerebellum SA for each sex and combined

Group	Cerebellum SA (pixels ²)		
	Males	Females	All
NT Control	433.53 ± 6.01	420.50 ± 2.45	427.02 ± 3.66
FGF-2 Control	444.20 ± 3.93	425.94 ± 5.47	433.76 ± 4.25
NT PPC	449.78 ± 2.47*	444.83 ± 0.97*	447.53 ± 1.56**
FGF-2 PPC	451.64 ± 7.76*	454.56 ± 6.25**	453.39 ± 4.59**

* significantly different than NT Controls at $p \leq 0.05$

** significantly different than NT Controls at $p \leq 0.001$

2.3.3.4. Cortical SA

Dorsal cortical surface area was significantly reduced in rats following PPC lesions, whether or not they had also received FGF-2 treatment (see Figure 2-8). Further, the FGF-2 PPC group showed a decrease relative to the untreated PPC rats, as well. The negative affect of FGF-2 on cortical area was restricted to lesion rats, however, and did not appear to impact on measurements from FGF-2 control rats.

An ANOVA with lesion and treatment as variables showed a main effect of lesion, $F(1,43) = 78.045$, $p = 0.000$, but not treatment, $F(1,43) = 0.945$, $p = 0.337$. There was, however, an interaction of group and treatment, $F(1,43) = 4.668$, $p = 0.036$.

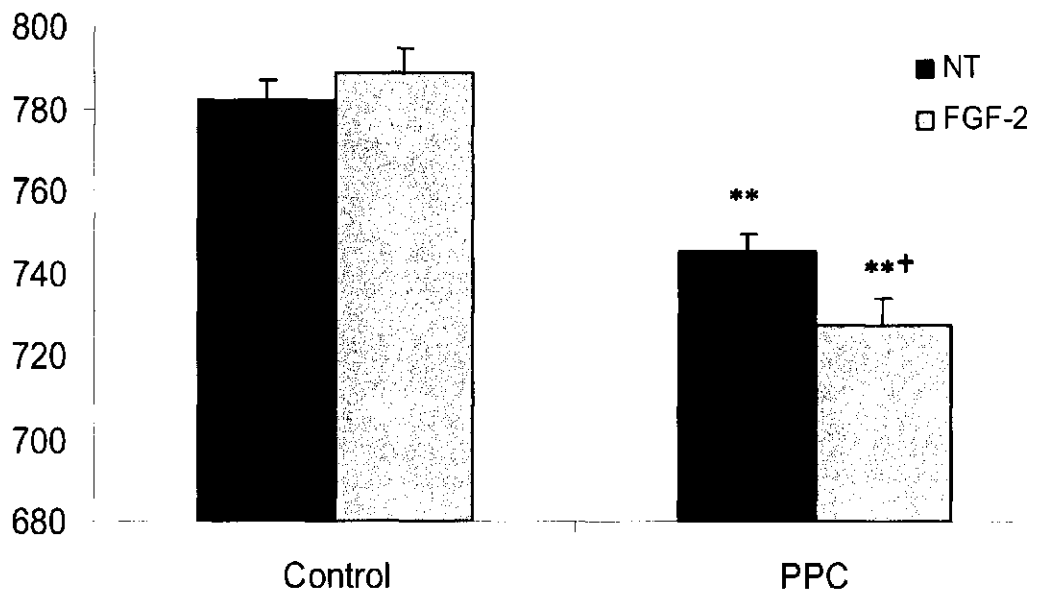

** significantly different from controls at $p = 0.000$

† significantly different from NT PPC group at $p = 0.05$

Figure 2-8 Mean cortical surface area measured in pixels².

A Fisher's LSD test showed a significantly smaller cortical SA in both the NT PPC and FGF-2 PPC group relative to controls ($p = 0.000$ & $p = 0.000$, respectively). Further, FGF-2 PPC rats had significantly smaller cortical SA relative to the NT PPC rats ($p = 0.041$), but there was no difference between the untreated and treated controls ($p = 0.379$).

2.3.3.5. Cortical Thickness

Measurements of the three locations on five cortical planes showed that the effect of lesion and treatment varied with each. Rats with lesions of the PPC showed a decrease in medial cortical thickness whereas rats with PPC lesions plus FGF-2 treatment did not (see Figure 2-9a). In contrast, whereas the lateral cortex was also decreased in lesion rats, FGF-2 did not have an affect as treated lesion animals also had a reduced cortical mantle relative to controls (see Figure 2-9b). Further, although there was only a decrease in the ventral cortex on the most posterior plane following PPC lesions, FGF-2 treated lesion rats showed a thinning of the cortical mantel on all but the anterior plane relative to controls (see Figure 2-9c).

A Repeated Measures ANOVA of the **medial cortex** on five cortical planes with lesion and treatment as variables showed a main effect of lesion, $F(1,35) = 19.52$, $p = 0.000$, but no main effect of treatment, $F(1,35) = 0.827$, $p = 0.369$. There was however, an interaction of lesion and treatment, $F(1,35) = 7.01$, $p = 0.012$. A Fisher's LSD test showed that PPC lesions rats had significantly thinner cortices on all planes except the first ($p = 0.60$; $p = 0.002$; $p = 0.003$; $p = 0.000$; $p = 0.033$, respectively). Aside

from a significant decrease in cortical thickness in FGF-2 controls on Plane 1 ($p = 0.017$), no other differences were found (p 's > 0.05).

A Repeated Measures ANOVA of **lateral cortex** showed a main effect of lesion, $F(1,41) = 42.89$, $p = 0.000$, but not treatment, $F(1,41) = 2.466$, $p = 0.124$, nor the interaction, $F(1,41) = 0.053$, $p = 0.820$. A Fisher's LSD test showed that PPC lesions resulted in a thinner lateral cortical mantle on Planes 2, 3, and 5, but not on Planes 1 and 4 ($p = 0.127$; $p = 0.000$; $p = 0.000$; $p = 0.255$; $p = 0.000$, respectively). Similarly, rats with PPC lesions that had received FGF-2 treatment showed a reduction in cortical thickness on all planes except Plane 4 ($p = 0.005$; $p = 0.000$; $p = 0.000$; $p = 0.134$; $p = 0.000$, respectively). There were no other differences found among the groups (p 's > 0.05).

A Repeated Measures ANOVA of the **ventral cortex** with lesion and treatment as variables showed a main effect lesion, $F(1,41) = 5.214$, $p = 0.028$, a trend for main effect of treatment, $F(1,41) = 3.122$, $p = 0.085$, and no interaction, $F(1,41) = 0.073$, $p = 0.788$. A Fisher's LSD test showed that rats with lesions of the PPC that had received FGF-2 treatment had a significant reduction in the ventral cortex on all planes except Plane 1 ($p = 0.657$; $p = 0.013$; $p = 0.048$; $p = 0.011$; $p = 0.005$, respectively) relative to controls and on Planes 2 and 4 ($p = 0.024$; $p = 0.032$, respectively) relative to untreated PPC lesion rats. PPC lesions alone produced a thinner ventral cortex only on the most posterior plane ($p = 0.984$; $p = 0.887$; $p = 0.146$; $p = 0.736$; $p = 0.003$, respectively).

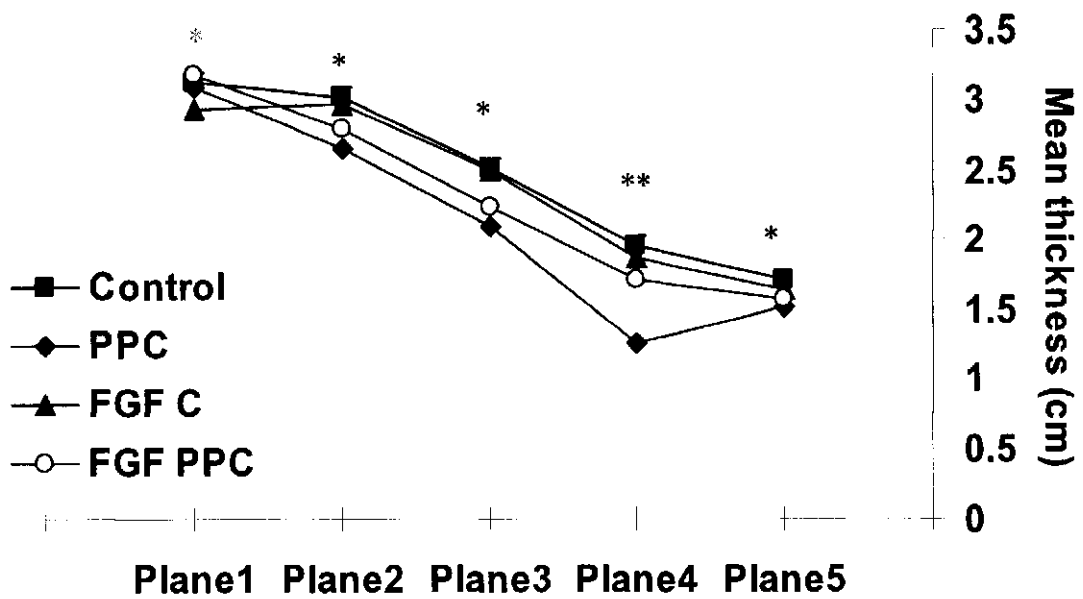

(a) Medial Cortex

- * significant difference between PPC lesion rats and controls
- * significant difference between FGF-2 PPC lesion rats and controls
- * significant difference between FGF-2 controls and NT controls

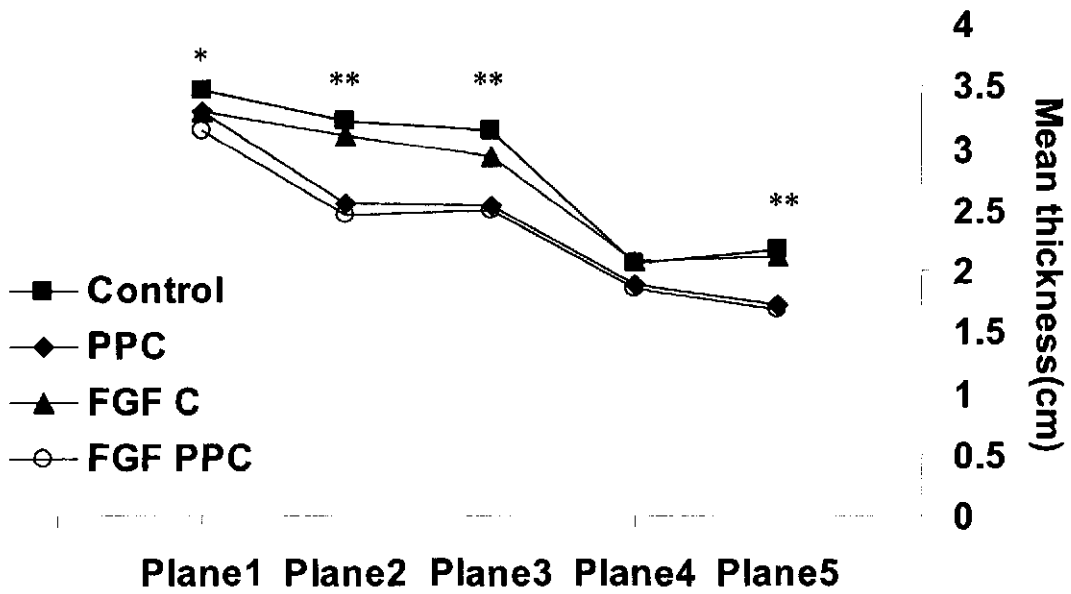

(b) Lateral Cortex

- * significant difference between PPC lesion rats and controls
- * significant difference between FGF-2 PPC lesion rats and controls

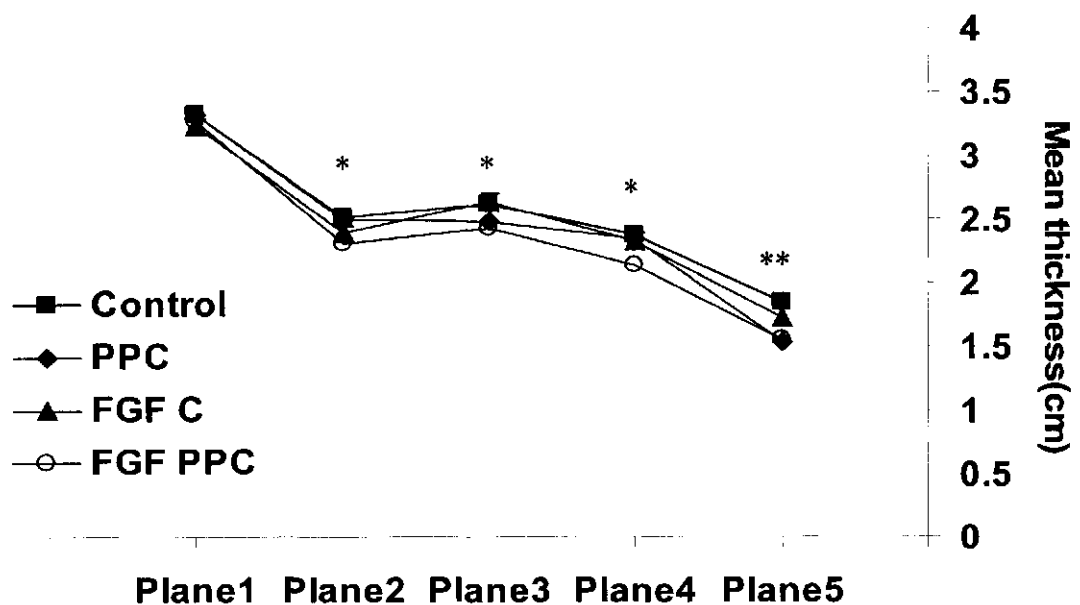

(c) *Ventral Cortex*

* significant difference between PPC lesion rats and controls

* significant difference between FGF-2 PPC lesion rats and controls

Figure 2-9 Summary of average cortical thickness of each plane measured at three locations: (a) medial, (b) lateral, and (c) ventral-lateral (ventral)

2.3.3.6. Anterior and Posterior Thalamic Sections

The general finding was that posterior parietal cortical lesions reduced anterior thalamic cross-sectional measures, but not the posterior measures (see Table 2-9). FGF-2 treatment did not influence the size of the anterior thalamic cross-sectional area. In contrast FGF-2 treated rats with PPC lesions showed a reduction in posterior thalamic cross-sectional measurements that was otherwise absent in the untreated lesion group. An ANOVA of anterior thalamic measurements with lesion and treatment as variables revealed a main effect of lesion $F(1, 41) = 82.26, p \leq 0.000$, but no main effect of treatment $F(1, 41) = 1.24, p = 0.273$, and no interaction, $F(1,41) = 0.188, p = 0.667$. An ANOVA of the posterior thalamic measurements showed a main effect of treatment, $F(1,43) = 7.91, p =$

0.007, but no main effect of lesion, $F(1,43) = 0.67, p = 0.417$, and no interaction, $F(1,43) = 2.81, p = 0.101$. A Fisher's LSD showed a significantly smaller anterior thalamic area in FGF-2 PPC rats relative to the untreated PPC rats ($p = 0.021$), but no other significant differences between groups (p 's > 0.05).

Table 2-9 Summary of mean measurements of thalamus and brain stem measures.

Thalamic Cross sectional Measurements (mm ²)		
Group	Anterior	Posterior
NT Controls	18.77 ± 0.42	31.88 ± 0.58
FGF-2 Controls	18.45 ± 0.23	31.24 ± 0.56
NT PPC	14.74 ± 0.59**	32.37 ± 0.43
FGF-2 PPC	14.02 ± 0.66**	29.83 ± 0.66†

** significantly different from NT Controls at $p \leq 0.001$

† significantly different from NT PPC at $p \leq 0.05$.

2.3.3.7. Lateral Posterior (LP) Thalamic Nuclei

Observations of the lateral posterior nuclei (LP) showed that dorsal portion of the LP is somewhat raised creating 'shoulders' (see Figure 2-10a). The PPC lesion rats showed a general disorganization of the LP that was marked by an abnormal or absent dorsal 'shoulder' region of the LP (see Figure 2-11a). Further magnification (200X), of the LP showed cellular disorganization and what appeared to be gliosis, as well (see Figures 2-10c and 2-11c). Treatment with FGF-2 did not appear to influence thalamic organization as similar observations were made in the FGF-2 treated PPC lesion animals (see Figures 2-13a and 2-13c). FGF-2 treatment did not have any obvious affect on rats without lesions (see Figure 2-12a), however, although there may have been a slight increase in the ratio of glia (see Figure 2-12c).

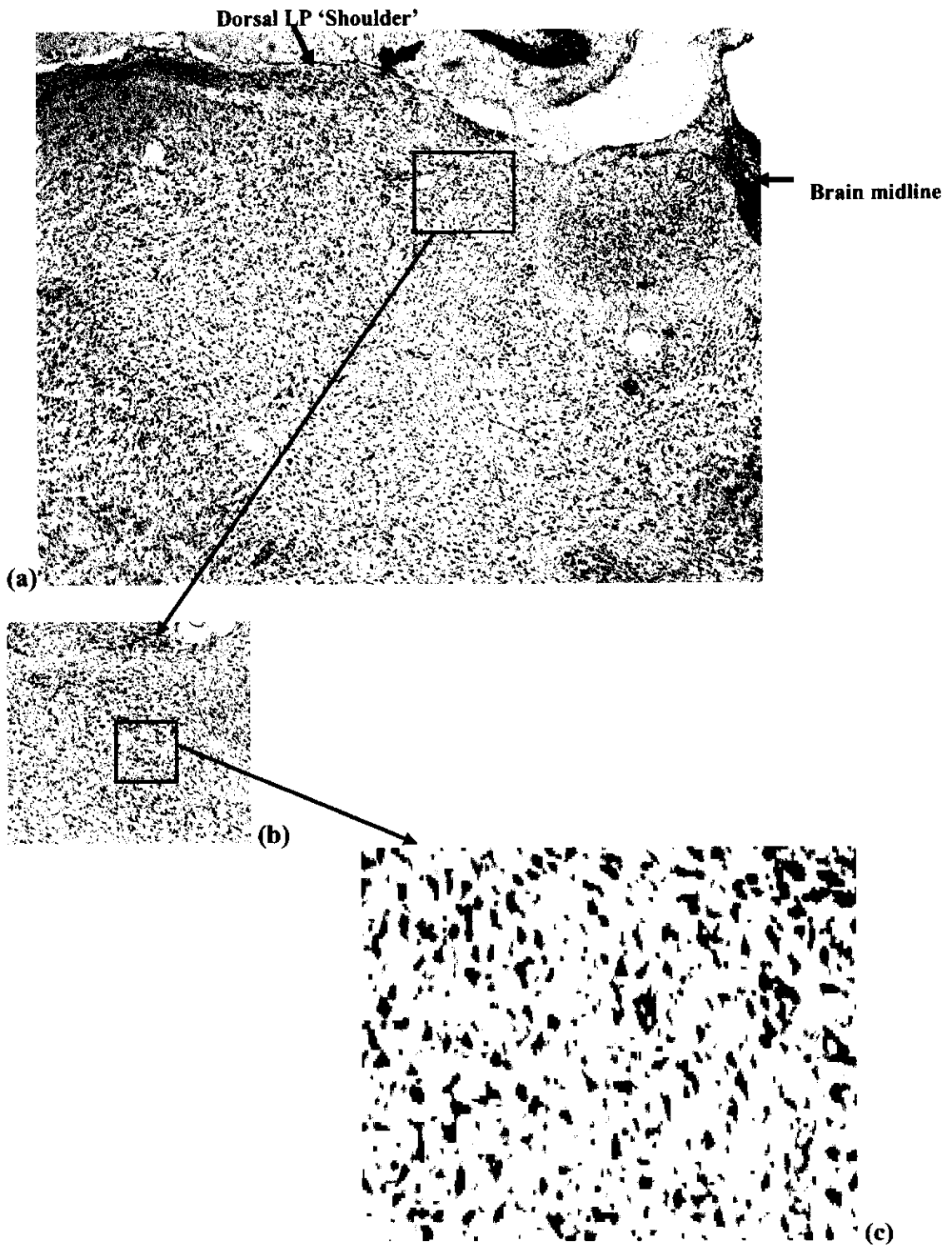

Figure 2-10 *NT Control (a) The LP of a treated rat magnified to 5X, (b) excerpt of above magnified (200X) to illustrate cell organization within the LP, and (c) an enlarged excerpt to illustrate cell form and type.*

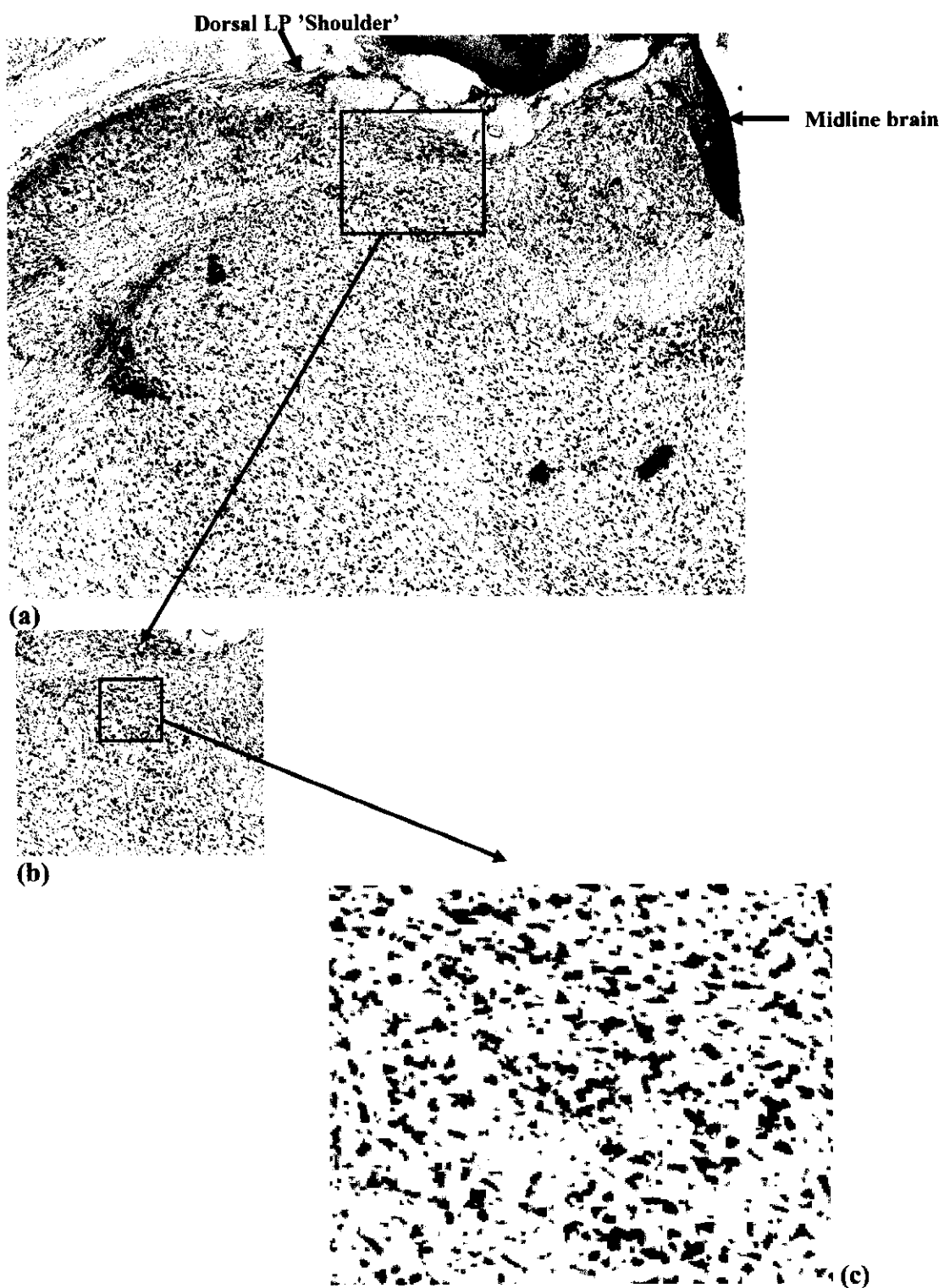

Figure 2-11 *NT PPC (a) The LP of an untreated rat magnified to 5X (b) excerpt of above magnified (200X) to illustrate cell organization within the LP, and (c) an enlarged excerpt to illustrate cell form and type*

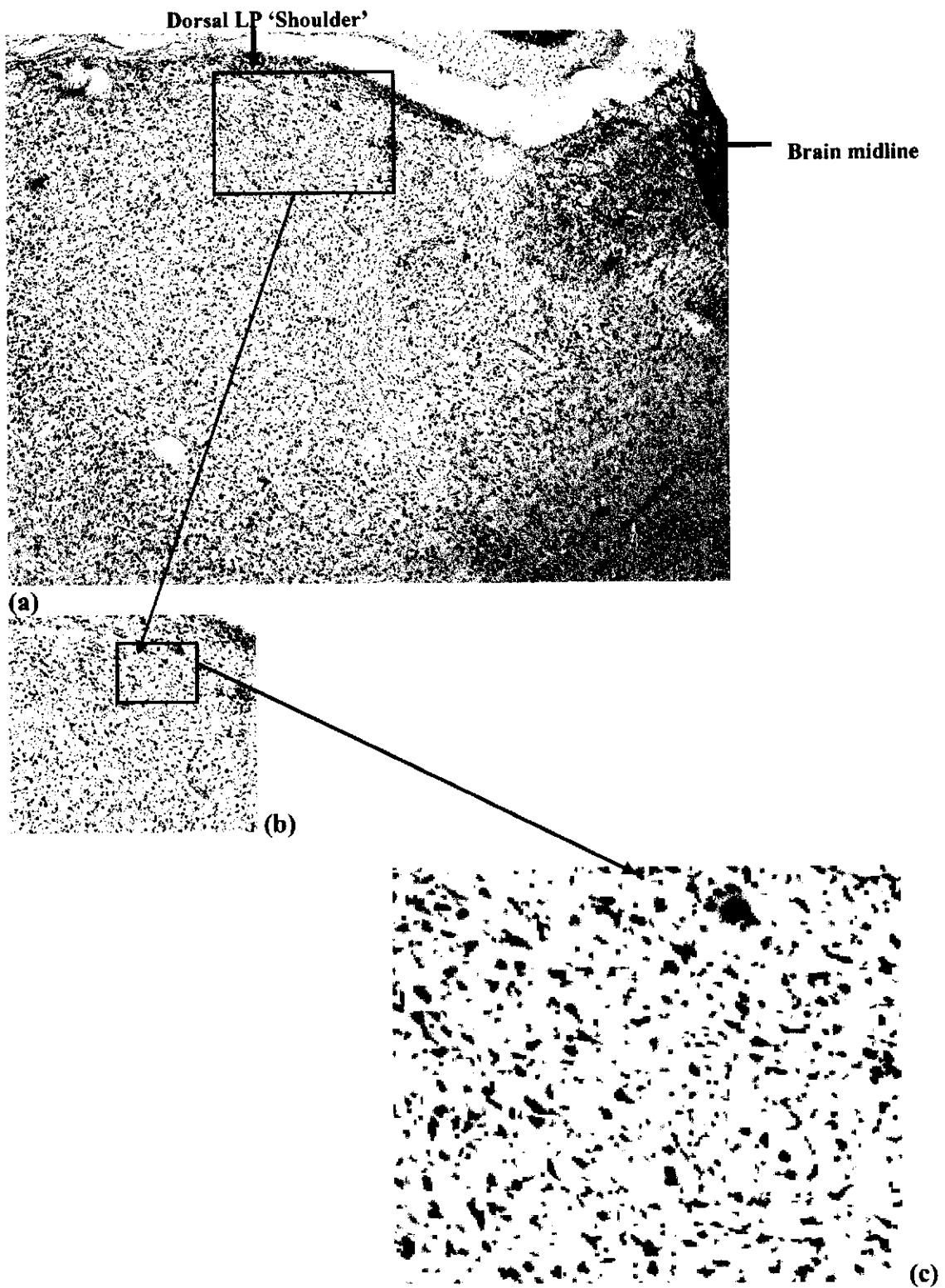

Figure 2-12 *FGF-2 Control (a) The LP of a treated rat magnified 5X, (b) magnified excerpt from above (200X) to illustrate cell organization within the LP, and (c) an excerpt enlarged to illustrate cell form and type*

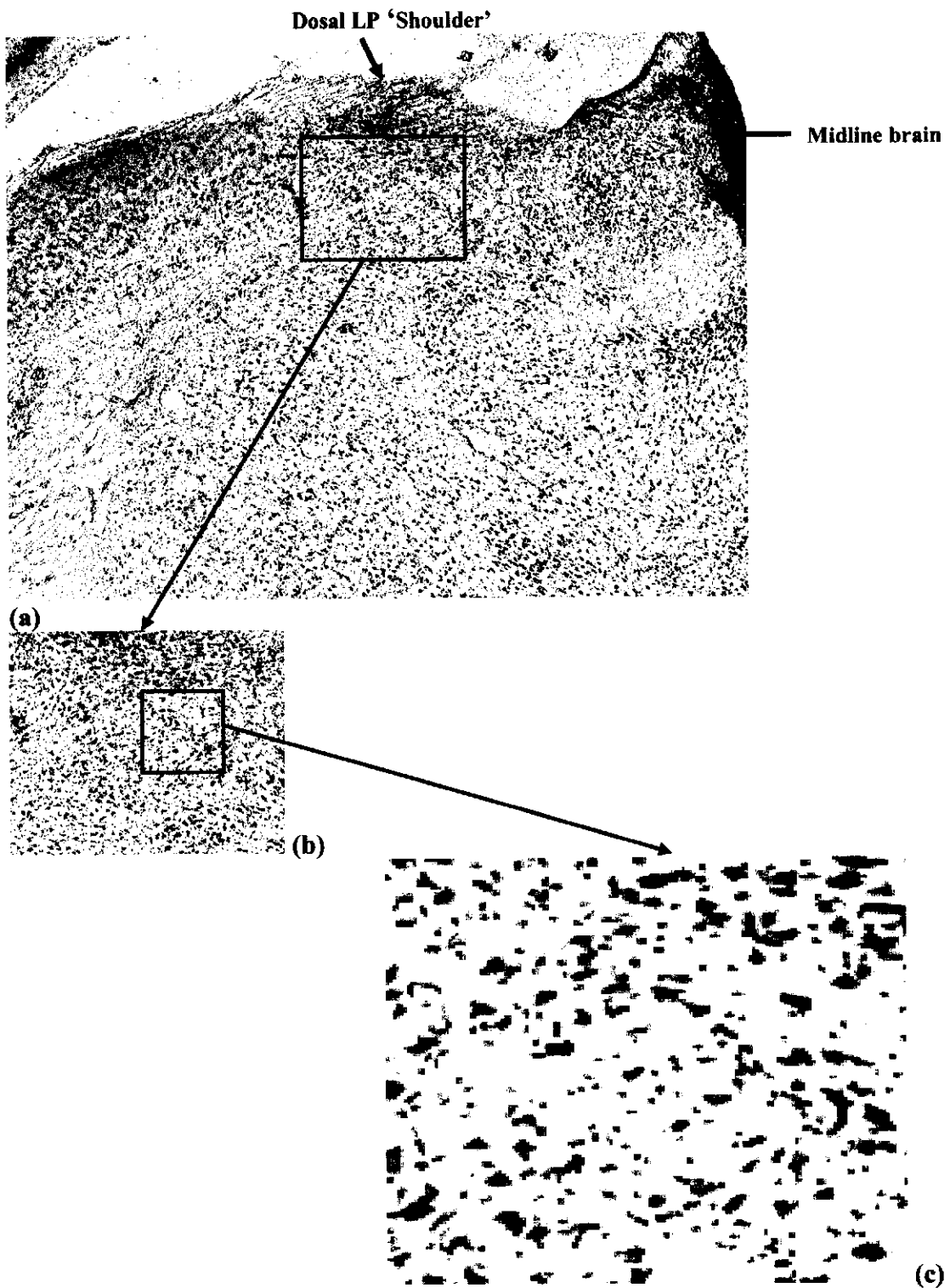
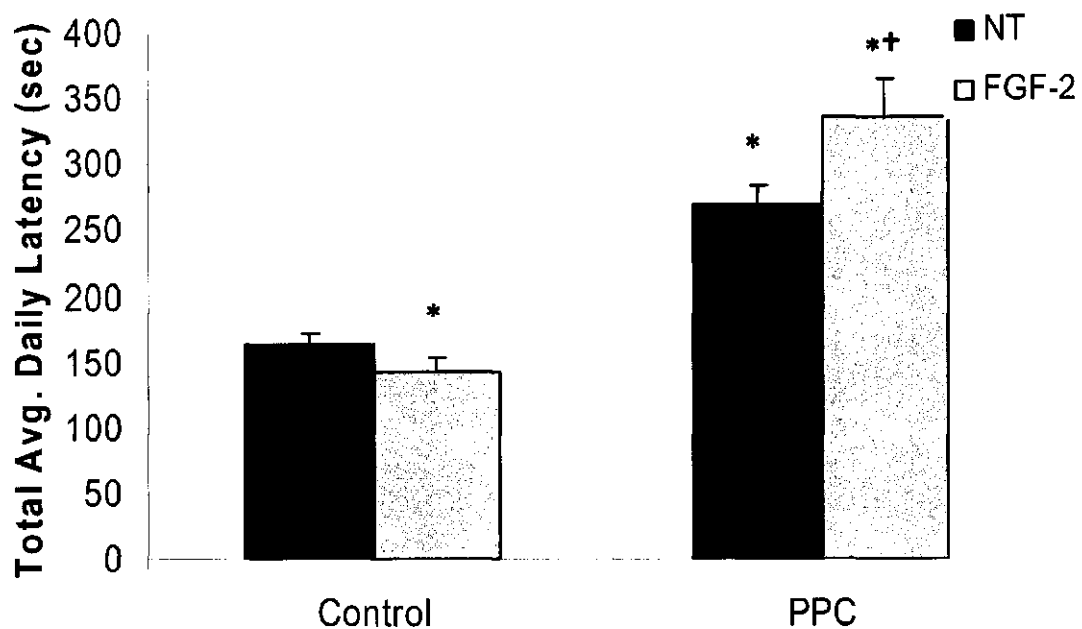

Figure 2-13 *FGF-2 PPC (a) The LP of a treated rat magnified to 5X (b) excerpt of above magnified (200X) to illustrate cell organization within the LP, and (c) an enlarged excerpt to illustrate cell form and type*

2.3.4. BEHAVIOURAL RESULTS

2.3.4.1. Morris Water Task

Rats with lesions of the PPC were impaired in the place task version of the Morris Water Task (see Figure 2-14). FGF-2 failed to lessen the impairment, as FGF-2 treated rats with PPC lesions had the highest sum latency over seven trial blocks.



* significantly different than NT Controls at $p \leq 0.05$
† significantly different than NT PPC group at $p \leq 0.05$

Figure 2-14. Total latency of seven trial blocks

Inaccurate swim heading was a noticeable deficit in PPC lesion rats and persisted to the last trial block. These rats often left the pool edge on an inaccurate heading that required adjustment, resulting in a somewhat 'looping' path to the platform (see Figure 2-15). As

can be seen in the diagram, the animal appeared to be aware of the approximate location of the platform but had difficulty in acquiring the most direct path to it.

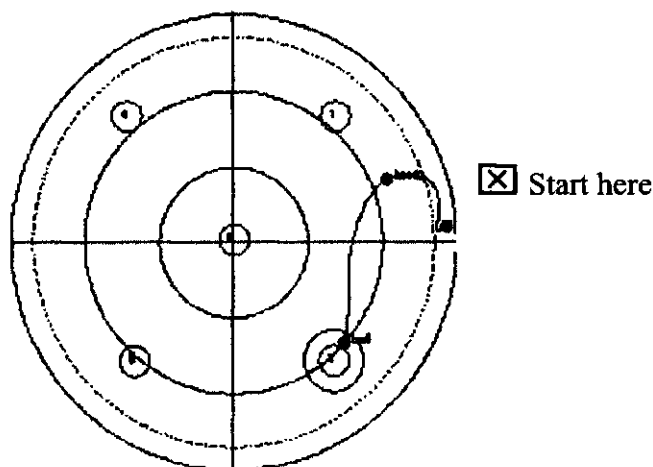
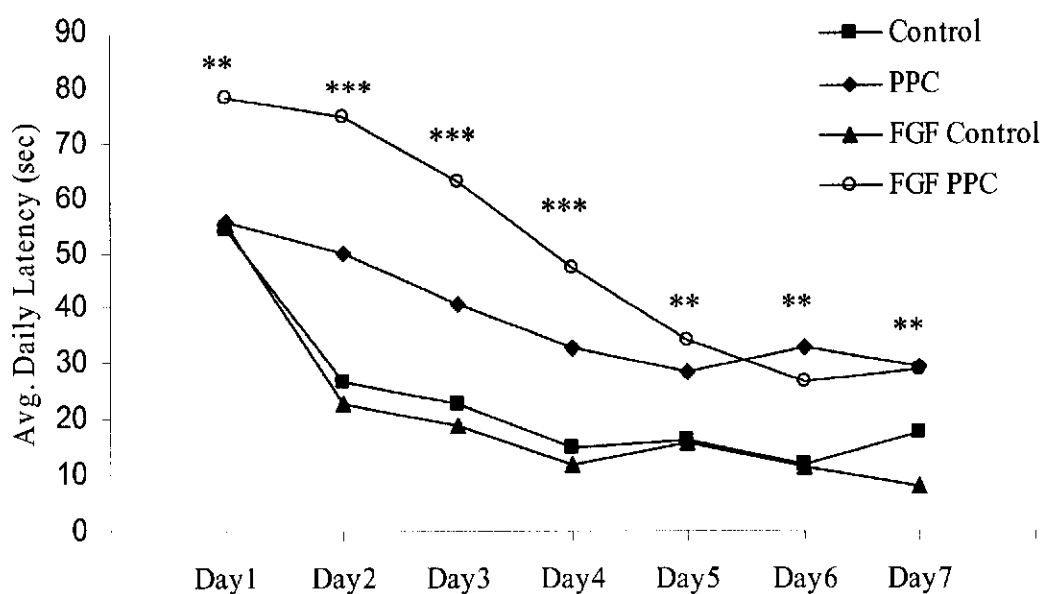

Figure 2-15 Example of representative swim path of rat with PPC lesion.

Owing to a high variance in the FGF-2 PPC group, a square root transformation was performed on the average latencies for each trial block and an ANOVA with group and treatment as variables was performed. Three extreme scores were removed from analysis. The results showed a main effect of lesion, $F(1, 41) = 114.19, p = 0.000$, with no main effect of treatment $F(1,41) = 0.611, p = 0.439$. More interesting, however, was the interaction of group and treatment, $F(1,41) = 11.21, p = 0.002$. A Fisher's LSD test showed a marginally significant increase in performance of the FGF-2 treated controls relative to the NT controls ($p = 0.055$). In contrast, PPC animals treated with FGF-2 performed significantly worse at the task relative to the NT PPC rats ($p = 0.010$).

A Fisher's LSD of Repeated Measures ANOVA of daily latencies showed an impairment relative to controls on every day (trial block), with the exception of Day 1, for the NT PPC rats ($p = 0.847, p = 0.002, p = 0.010, p = 0.000, p = 0.012, p = 0.000, p =$

0.006, respectively) and without exception for the FGF-2 PPC rats ($p = 0.001$, $p = 0.000$, $p = 0.000$, $p = 0.000$, $p = 0.001$, $p = 0.000$, $p = 0.011$, respectively). Further, the FGF-2 rats were significantly worse than their untreated counterparts on all but the last three trial blocks ($p = 0.003$, $p = 0.004$, $p = 0.005$, $p = 0.013$, $p = 0.427$, $p = 0.182$, $p = 0.916$, respectively).



- * FGF-2 PPC significantly different from NT controls at $p \leq 0.05$
- * PPC significantly different from NT controls at $p \leq 0.05$
- * FGF-2 PPC significantly different from NT PPC at $p \leq 0.05$

Figure 2-16 Mean daily latencies over seven trial blocks

The differences in latency to find the platform were not due to swim speed. A One-way ANOVA of swim speed did show a main effect of group, $F(3,43) = 5.01$, $p = 0.005$, but a Fisher's LSD showed a trend towards an increase in swim speed of the PPC lesion group relative to controls, as well as a significant increase in both the FGF-2 PPC

and FGF-2 control group swim speeds relative to controls ($p = 0.073$, $p = 0.002$, $p = 0.005$, respectively).

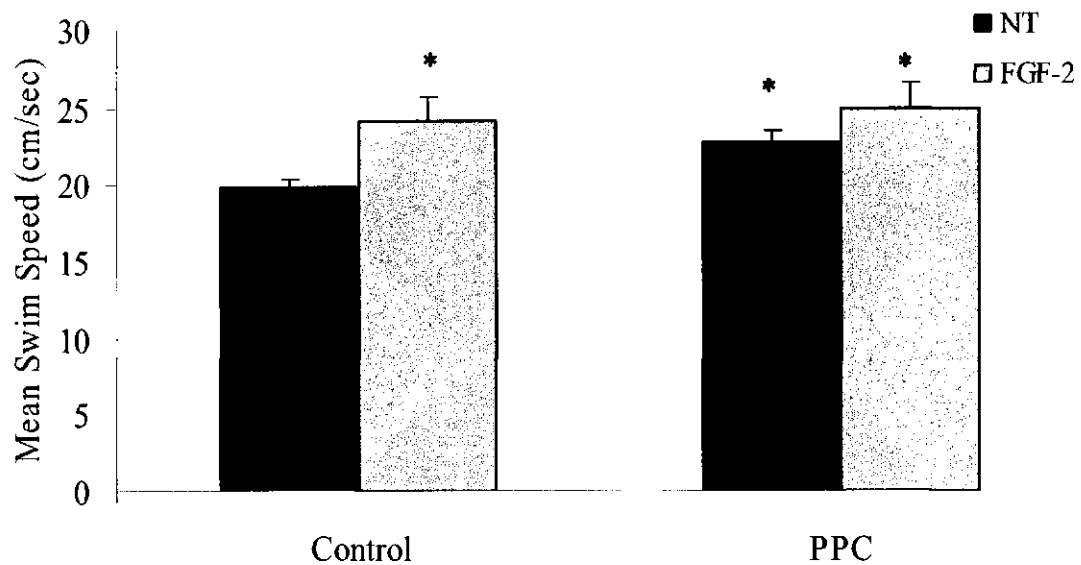

* significantly different than NT Controls at $p \leq 0.05$

Figure 2-17 Mean swim speed

2.3.4.2. *Whishaw Tray Reaching*

Controls had an average reaching success of about 65% whereas the posterior parietal groups were slightly worse (60% for NT; 52% for FGF-2) (see Figure 2-18). An ANOVA with lesion and treatment as variables revealed a main effect of lesion ($F(1,48) = 5.81$, $p = 0.02$), but no main effect of treatment, $F(1,43) = 1.79$, $p = 0.188$, and no interaction of lesion and treatment, $F(1,43) = 0.726$, $p = 0.399$. Owing to the unexpected lesion effect, a Tukey's post hoc was performed. The results showed that the main effect of lesion group reflected the small deficit observed in FGF-2 lesion rats relative to controls ($p = 0.06$).

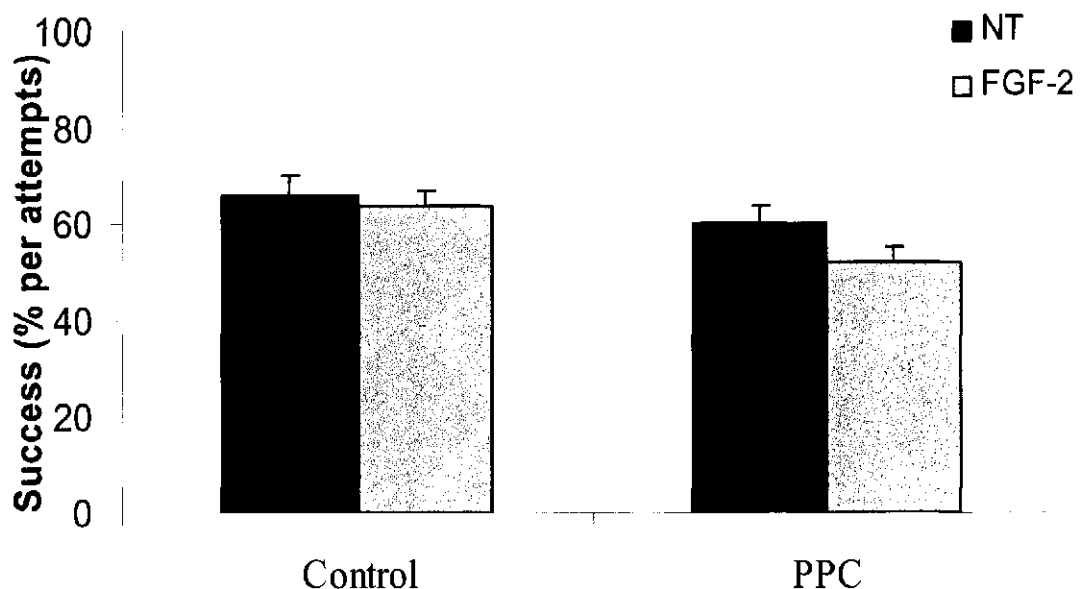

Figure 2-18. Mean percentage of reaching attempts that were successful.

2.3.4.3. Open Field Task

There were no group differences in open field activity (see Table 2-10). An ANOVA showed that the groups were comparable in activity levels, $F(1,30) = 0.038$, $p = 0.963$. Owing to the exceptionally low variance of the FGF-2 controls, this group was analyzed separately with NT controls in a t -test with equality of variance not assumed. The results showed that there was no difference between control groups, $t(24) = -1.126$, $p = 0.279$.

Table 2-10. Mean of distance, horizontal, vertical, and number of movements.

Group	Treatment	
	NT	FGF-2
Control	428.30 ± 36.30	472.10 ± 13.98
PPC	431.59 ± 45.51	416.68 ± 33.94

2.4. DISCUSSION

Two experiments were used to examine the potential of exogenous FGF-2 in the enhancement of functional recovery following either bilateral medial frontal or bilateral posterior parietal cortical lesions at postnatal day 3 (P3). Table 2-11 summarizes the results of the anatomical and behavioral measures.

Table 2-11. Summary of results from Experiment 1.1 and 1.2.

(❖◆) significant decrease/increase relative to NT Lesion counterpart; (❖◆) significant increase/decrease relative to untreated Controls; (⌘) no significant difference relative to Controls; (NA) not applicable;

Abbreviations: M = medial cortex, L = lateral cortex, V = ventral cortex.

Note: A decrease/increase in medial, lateral, or ventral cortices was considered significant if two or more planes were significantly different relative to controls

RESULTS:	Anatomical								Behavioral		
	<u>Body Wt</u>	<u>Brain Wt</u>	<u>Cerebellum</u>	<u>Cortex SA</u>	<u>Lesion SA</u>	<u>Cortical planes</u>	<u>Thalamus</u>	<u>Brain Stem</u>	<u>Water task</u>	<u>Reaching</u>	<u>Open field</u>
NT MFC	⌘	❖	⌘	❖	⌘	❖	❖	❖	❖	❖	⌘
FGF MFC	❖	❖	◆	❖	❖	L,V MLV	❖	❖	⌘	❖	⌘
FGF C	❖	⌘	⌘	⌘	NA	⌘	⌘	⌘	◆	⌘	⌘
NT PPC	⌘	❖	◆	❖	NA	❖	❖	⌘	❖	⌘	⌘
FGF PPC	❖	❖	◆	❖	NA	M,L	❖	❖	❖	❖	⌘

Overall, the main results of the present study were: 1) Postnatal day 3 lesions of both the MFC and the PPC produced impairments in learning of the Morris Water task and MFC

lesions alone showed lower performance levels on the Whishaw Reaching task; 2) Both MFC and PPC lesions led to a reduced thickness of the cortical mantle and a reduction in the size of the thalamus; 3) Treatment of FGF-2 had little impact on either the behavioral outcome or anatomical results. Each finding will be discussed in turn.

2.4.1. Effects of postnatal day 3 MFC and PPC lesions on cognitive and motor tasks.

The cognitive and motor deficits that have been previously reported following MFC or PPC on postnatal day 3 (P3) were also found in the current experiment. Rats with either MFC or PPC lesions were impaired in the place task version of the Morris water task. The impairments, however, were not equal across lesion groups. First, based on daily latency scores, there were observable differences in the learning curve between MFC and PPC lesion rats suggesting that the impairment is less severe following MFC lesions than observed following PPC lesions. Second, MFC lesion rats typically started from the edge of the pool in the general direction of the platform, yet, showed a deficit in acquiring the exact location of the platform and had to search once in the vicinity. In contrast, the PPC lesion rats most often started from the pool edge in the wrong direction, but once they had corrected their heading, were able to locate the platform. These variations in searching for and locating the platform support the notion that MFC rats may be impaired at remembering the relationship between the cues and platform location, whereas the consistently inaccurate heading of the PPC lesion rats supports the findings that PPC deficits in spatial tasks are related to the movement of body through space.

MFC lesion rats, but not PPC lesion rats, were also impaired in the Whishaw tray reaching task. The MFC has a large number of neurons in Layer V that project to the

spinal cord (Miller, 1987). Thus, the motor deficit in skilled reaching following MFC lesions is likely the result of a substantial loss in corticospinal connections that due to the continued deficit, do not appear to reorganize over time.

2.4.2. Anatomical irregularities following P3 MFC and PPC lesions

A number of anatomical deficits were found following both MFC and PPC lesions. The most marked irregularities for both lesion groups were a thinning of the cortical mantle and a reduction in brain weight. It is likely that the reduction in cortical thickness was caused by a disruption in neuronal migration as a result of lesions at P3, a time when cortical migration is at a peak. The MFC lesion rats, however, showed a substantial decrease in the lateral and ventral, but not the posterior planes of the medial, cortices. In contrast, the PPC lesion rats showed a substantial decrease in the medial and lateral, but not ventral, cortices on most cortical planes.

The differing cortical decreases in the MFC versus the PPC lesion rats may be a result of the delayed development in the posterior cortex that has been reported previously (Bayer & Altman, 1991), thus migration may have been affected more in the PPC than MFC lesion rats due to the timing of the received lesion. Further, as there is also a ventral to lateral gradient, and a lateral to medial gradient, as well as the anterior to posterior gradient in cortical development, it may be that migration was disrupted at different points following MFC or PPC lesions, thus accounting for at least some of the discrepancy in cortical loss. The lack of reduced medial cortex on the posterior planes following MFC lesions is surprising, however, as previous research has consistently

shown a reduction in the posterior planes that could be attributed to the rerouting of migrating posterior cortical neurons as replacement cells for the injured MFC.

Brain weight was substantially decreased in adulthood following either the P3 MFC or P3 PPC lesions. A substantial loss in cortical cells, a thinning of the remaining cortical mantle, a decrease in the overall cortical surface area, and a shrinkage of thalamic cross-sectional area were all likely contributing factors in the reduced brain weight following cortical injury. Furthermore, that all these factors continue to show substantial losses into adulthood suggests limited plasticity exists at P3, a finding that is consistent with previous studies of MFC and PPC lesions.

2.4.3. Impact of post-operative FGF-2 on behavioral outcome and anatomical results following P3 MFC and PPC lesions

Subcutaneous injections of FGF-2 following MFC or PPC lesions on P3 produced differential effects on performance in the place task version of the Morris water maze. FGF-2 treated MFC lesion rats showed a modest improvement in latency, whereas the FGF-2 treated PPC lesion rats showed an increase in the deficit relative to their untreated lesion counterparts. Yet, FGF-2 treatment had similar effects for both lesion groups on performance in the reaching task. The FGF-2 MFC and FGF-2 PPC group both showed slight decreases in reaching success relative to their no treatment counterparts. This suggests a differential effect of FGF-2 that may be task related.

The supportive role of exogenous FGF-2 on functional recovery in the *place task* following a P3 MFC lesion was anticipated, although it was not as profound as had been reported in an earlier study (Kolb & West, 2000, unpublished). An examination of the

results showed that although the FGF-2 MFC rats improved on the task, they continued to use an inefficient 'looping' strategy to locate the platform, as had the untreated MFC rats. The slight improvement of the treated over untreated MFC groups was observable in the learning curve, or the timing of strategy development, albeit an inefficient one. The FGF-2 treated rats were able to acquire the task at a slightly faster rate than the NT MFC group.

The effect of FGF-2 treatment following P3 PPC lesions had not been previously studied, but the negative impact on functional recovery had not been expected. The reported role of FGF-2 in protecting and supporting neurons (e.g. against ischemic injury, Nozaki et al., 1993) had suggested a potential benefit for recovery following PPC as well, that was not found in the present study.

It was hypothesized that FGF-2 might stimulate the same plastic changes that appear to occur during the second week of development. As this protein has been shown to support neuronal cell survival and stimulate mitosis it was thought that a decrease in lesion size would be found. This, however, was not the case. In fact, MFC rats treated with FGF-2 had larger lesions than that of the untreated lesion rats.

2.4.4. Procedural problems and their implications

Two important procedural problems occurred during this study: 1) FGF-2 was diluted with a BSA vehicle and stored at about 5° C for the duration of the week-long application period. Unknown to us at the beginning of the experiment, however, FGF-2 is an unstable compound that may change biological activity when exposed to temperatures above about -20° C. For example, it may result in structural changes that

that would prevent the protein from attaching to perspective receptors. Therefore, there is the possibility that an affective change in the biological activity of the FGF-2 that was administered to the pups over the extent of the 7 days occurred and may have had an affect on the treatment outcome. 2) Changes to behavioral protocols, such that the time between trials, the platform location in the pool, and the size and form of the platform itself may have affected performance. The performance of control animals in the Morris water task was poorer than in previous studies, possibly because the protocols had been altered. In view of these considerations the experiment was repeated in Experiment 2. The FGF-2 was made fresh daily and the optimal testing parameters were used in the Morris water task (for a more detailed explanation see Appendix 1).

3. *Experiment 2: Effects of Postnatal FGF-2 following P3 MFC and PPC cortical lesions*

ABSTRACT

Rats with focal lesions of the medial prefrontal cortex (MFC) show deficits in both spatial navigation and fine motor skills of the forelimb, whereas posterior parietal cortical (PPC) lesions produce deficits in spatial navigation but not forelimb movement. It has been speculated that exogenous basic fibroblast growth factor (FGF-2) may influence neuronal survival following injury, thus reducing behavioral deficits. On postnatal day 3 (P3) pups received MFC, PPC, or sham lesions. Pups either received no treatment or 0.01 µg/gram of body weight of FGF-2. The FGF-2 was mixed daily and administered subcutaneously for seven consecutive days following surgery. As adults, the rats were tested on a cognitive (Morris water) and motor movement (skilled reaching) task. There was a significant functional improvement in the FGF-2 treated lesion rats relative to untreated controls. Anatomical measures showed that treated MFC, but not PPC, lesion rats had reduced cortical thinning and an increased brain weight relative to their untreated lesion counterparts. Overall, these results suggest that FGF-2 may enhance behavioral functional recovery by decreasing anatomical effects of early postnatal lesions.

3.1 INTRODUCTION

Injury to the brain at postnatal day 3 (P3) has devastating and enduring effects in the rat. Although the extent of potential recovery varies with the location of injury, two areas, the medial prefrontal cortex (MFC) and posterior parietal cortex, show very poor functional recovery at this time (Kolb & Cioe, 2000; Kolb, Petrie & Cioe, 1996; Kolb & Whishaw, 1985). Yet, similar injury at a later age results in a better functional outcome. A proposed explanation for the differential recovery is that specific neurotrophic support systems needed for neuronal survival are not yet developed. For example, postnatal basic fibroblast growth factor (FGF-2), implicated in both mitosis and neuronal and glia survival, is at a minimal level in the rat neocortex until the second week of life (Gomez-Pinilla, Lee & Cotman, 1994), a time that corresponds with good functional recovery following MFC lesions (Kolb & Gibb, 1993; Kolb, Gibb, Gorny & Whishaw, 1998). This suggests that FGF-2 may be an important factor in functional recovery.

Previous research has shown that FGF-2 enhances functional recovery and may also stimulate neurogenesis following P3 MFC lesions (Kolb et al., 2000). Aside from the previous experiment just presented, there is no existing research that has examined the involvement of FGF-2 in enhancing functional recovery following PPC injury. Although, the data presented showed only a modest benefit of FGF-2 in behavioral functional recovery following P3 MFC and PPC brain damage, it was hypothesized that a few procedural changes would heighten the effect.

Further, in a similar experiment in which P3 MFC lesion pups were analyzed at P21, a regrowth of brain tissue that filled the lesion cavity had been found (R. Gibb & R. Diaz, unpublished). The pups that showed signs of regrowth had received FGF-2 protein

that was mixed with a BSA vehicle on a daily basis, thus reducing the possibility of changes in biological activity. These findings suggested that perhaps the dilution procedures of FGF-2 in the earlier experiment had compromised the effectiveness of the protein, and was insufficient in stimulating neurogenesis as had been proposed. A question that was not addressed by the regrowth study, however, was whether or not the new tissue was indeed functional. It is possible that the cells may have failed to make necessary connections and would have subsequently died if the pups had been left to mature.

In Experiment 1, a one week supply of FGF-2 was prepared ahead of time and administered subcutaneously for seven consecutive days following either MFC or PPC lesions on postnatal day 3 (P3). The results of a spatial cognition task (water maze) and a motor task (skilled reaching) showed some improvements in behavioral functioning with FGF-2 treatment, but no anatomical correlates were discovered in the measurements taken. In the present experiment, by mixing FGF-2 on a daily basis prior to administration it was speculated that an effective dose of FGF-2 would be delivered that would not only enhance the behavioral functional recovery found in the previous experiment, but that such recovery would be extended to include anatomical correlates.

The present experiment was, therefore, designed to examine a number of questions. First, would procedural changes in the delivery of FGF-2 after P3 MFC or PPC lesions enhance functional recovery? Second, would regrowth occur and persist into adulthood? Third, would there be anatomical recovery as well as functional recovery? If any new tissue were viable, not only should the lesions be less extensive than in the first experiment, but the behavioral results should also reveal an increase in functionality.

3.2 MATERIALS AND METHODS

3.2.1. Subjects

Ninety-seven Charles River Long-Evans rats (46 M; 51 F) were used in the behavioral tests. Eight animals were removed from the study due to erroneous lesions. Twenty-eight of those remaining were not included in anatomical analyses (7 were used for an unrelated golgi study; 21 were for behavioral analyses only). Pups were grouped in a two-stage process. In the first stage, pups were randomly assigned to receive one of three lesions at P3: [1] sham lesions (M, 12; F 14), [2] medial frontal cortical lesion (14 M; 17 F), and [3] posterior parietal cortical lesions (15 M; 17 F). In the second stage, litters were assigned to one of two treatment groups: [1] no-treatment (NT) and [2] postnatal FGF-2 (FGF-2), (N = 44; N = 45, respectively). Six groups were created: [1] NT sham (N = 13, 5M ; 8F), [2] NT MFC (N= 15, 6M ; 9F), [3] NT PPC (N = 16, 7M ; 9F), [4] FGF-2 sham (N = 13, 7M ; 6F), [5] FGF-2 MFC (N = 16, 8M ; 8F), [6] FGF-2 PPC (N = 16, 8M ; 8F). The above groups were divided into two experiments. *Experiment 2.1* included 4 groups; [1] NT sham, [2] NT MFC, [3] FGF-2 sham, [4] FGF-2 MFC. *Experiment 2.2* also included 4 groups; [1] NT sham, [2] NT PPC, [3] FGF-2 sham, [4] FGF-2 PPC.

Pups were housed with dams in clear plexi-glass hanging tubs on a 12 hr light/dark schedule until weaned and later housed in litter-mate, same-sex groups of 2-3. Ad-lib food and water was available throughout the behavioral testing period, except for a period of food deprivation during the Whishaw reaching task. Behavioral testing began when pups were about 60 days old. Following behavior testing, animals were sacrificed and brains were prepared for anatomical analysis.

3.2.2. Surgical and Anatomical Procedures

The procedures in Experiment 1 were replicated with the exception of the preparation of FGF-2.

3.2.3. FGF-2 Preparation

Using BSA as a vehicle, FGF-2 was converted from powder to liquid form. Once converted, the protein was transferred to aliquots at a concentration of 1 µg FGF-2 to 20 µl of BSA and stored at about -80 ° C. Each day the required aliquots were removed from the freezer and diluted at 1 µg FGF-2 per 1ml of BSA. Beginning 24 hours after surgery, the pups were weighed and administered FGF-2 subcutaneously between the shoulder blades. The dosage was 0.01 µg per gram of body weight. Pups were weighed every other day and the prescribed dose adjusted accordingly.

3.2.4. Behavioral Procedures

As with the anatomical procedures, the behavioral procedures were replicated with one exception, the Morris Water Task.

Morris Water Task

In the present experiment five procedures used in the Morris Water task from Experiment 1 were modified (for details on rationale see discussion in Experiment 1). One, there was not a 20 minute delay enforced between the swim trials. Two, the water temperature was raised to 23 ° C. Three, the hidden platform was square, rather than round. Four, the platform location was moved to the same end of the pool as the holding cages. Five, there were now more distal cues in the room. These changes were not biased

in that they benefited all groups, allowing for a more rapid acquisition of the task (Gonzalez, Kolb & Whishaw, 2000).

3.2.5. Statistical Methods

Analyses of variance were used for all statistical measures except where homogeneity of variance was violated. In these cases, a Mann Whitney-U or Student's *t*-test was used. *Post hoc* evaluations were conducted with Fisher's LSD ($P < 0.05$) unless the results were unexpected, thus truly post hoc, in which case the more conservative Tukey's HSD ($P < 0.05$) was performed.

3.3 RESULTS

Experiment 2.1 Medial prefrontal cortical lesions

3.3.1. ANATOMICAL RESULTS

3.3.1.1. Body Weight

There was an overall sex difference in body weight, with males having a higher weight on average than females. Therefore, separate analyses were performed for each sex. Treatment with FGF-2 following early MFC lesions resulted in lower body weights in both the male and female groups (see Table 3-1). For males, an ANOVA, with treatment and lesion as variables, showed a main effect of lesion $F(1,21) = 6.25, p = 0.021$, but no main effect of treatment, $F(1,21) = 0.811, p = 0.378$, nor the interaction, $F(1,21) = 0.022, p = 0.883$. For females, an ANOVA with treatment and lesion as variables also showed a marginal main effect of lesion $F(1,26) = 3.95, p = 0.057$, but no main effect of treatment, $F(1,26) = 3.48, p = 0.073$, nor the interaction, $F(1,26) = 0.152, p = 0.700$.

Table 3-1. Summary of mean body weights

Group	Body Weight (grams)	
	Male	Female
NT Control	436 ± 34	302 ± 14
FGF-2 Control	419 ± 26	278 ± 8
NT MFC	382 ± 21	276 ± 7
FGF-2 MFC	358 ± 11*	260 ± 10*

*significant at ≤ 0.05

Fisher's LSD tests of body weight showed that both males and females treated with FGF-2 following a MFC lesion had a significant reduction in body weight relative to the NT

same-sex controls (p 's < 0.05). There were no other differences among groups (p 's > 0.05).

3.3.1.2. Brain Weight

Sexes were analyzed separately. The results showed that MFC lesions in both males and females resulted in lighter brain weight in adulthood relative controls (see Table 3-2). Treatment with FGF-2 had a differential affect on brain weight. Males in both the FGF-2 control group and the FGF-2 MFC group showed a lower brain weight relative to same-sex controls, whereas female FGF-2 lesion rats, but not FGF-2 controls, showed a reduction in brain weight relative to same-sex controls. Similarly, in lesion males, FGF-2 treatment resulted in lighter brain weights than the untreated lesion rats, whereas there was no significance difference between the treated and untreated female lesion rats.

Table 3-2. Summary of mean brain weights in grams

Brain Weight(grams)		
Group	Male	Female
NT Control	1.75 ± .02	1.54 ± .04
FGF-2 Control	1.60 ± .01**	1.56 ± .04
NT MFC	1.49 ± .03**	1.40 ± .04*
FGF-2 MFC	1.41 ± .02**†	1.41 ± .02*

* significantly different from NT Controls at $p \leq 0.05$

† significantly different from NT MFC at $p \leq 0.05$

** significantly different from NT Control at $p \leq 0.001$

For males, an ANOVA with lesion and treatment as variables showed a main effect of lesion, $F(1,21) = 99.616$, $p = 0.000$, and treatment, $F(1,21) = 27.266$, $p = 0.000$,

but no interaction $F(1,21) = 2.70, p = 0.115$. For females, an ANOVA showed a main effect of lesion, $F(1,25) = 20.74, p = 0.000$, but no main effect of treatment, $F(1,25) = 0.144, p = 0.708$, nor the interaction, $F(1,25) = 0.101, p = 0.753$. Fisher's LSD tests showed that MFC lesions resulted in significantly lower brain weights for males ($p = 0.000$), as did postnatal FGF-2 whether or not they had received a lesion ($p = 0.000$ & $p = 0.014$, respectively). MFC lesion females also showed a reduction in brain weight relative to controls, whether or not they had received FGF-2 ($p = 0.004$ & $p = 0.018$, respectively)

3.3.1.3. Cerebellum

A sex difference was found, but as it was across groups the sexes were collapsed. Although MFC lesions did not themselves influence the dorsal surface area of the cerebellum, MFC lesion plus FGF-2 treatment substantially increased cerebellum size relative to the untreated lesion rats (see Table 3-3). The effect was limited to lesion rats as no differences were found between the treated and untreated controls.

Table 3-3. Summary of mean dorsal surface area of cerebellum in pixels²

Group	Cerebellum SA (pixels ²)	
	NT	FGF-2
Control	352.04 ± 6.57	354.05 ± 1.90
MFC	349.80 ± 4.68	364.12 ± 2.19*

* significantly different from NT MFC group at $p \leq 0.05$

An ANOVA with sex, treatment and lesion as variables showed a significant main effect of sex, $F(1,31) = 5.168, p = 0.030$, and treatment, $F(1,31) = 4.166, p = 0.040$, but not lesion, $F(1,31) = 0.834, p = 0.368$. There was however, an interaction of lesion and treatment, $F(1,31) = 4.482, p = 0.042$. No other significant interactions were found (p 's > 0.100). A Tukey's post hoc showed that FGF-2 MFC rats had significantly larger cerebellums relative to untreated MFC rats ($p = 0.016$), the FGF-2 controls ($p = 0.042$) and a trend towards significance relative to the untreated controls ($p = 0.079$). In contrast, the cerebellum of untreated MFC lesion rats was comparable to the controls ($p = 0.979$).

3.3.1.4. Cortical SA

Lesions of the MFC resulted in a significantly smaller cortical surface area relative to controls, irrespective of treatment (see Figure 3-1). There was no apparent influence of FGF-2 treatment, although the FGF-2 MFC group did have a moderate decrease in cortical SA relative to untreated lesion rats.

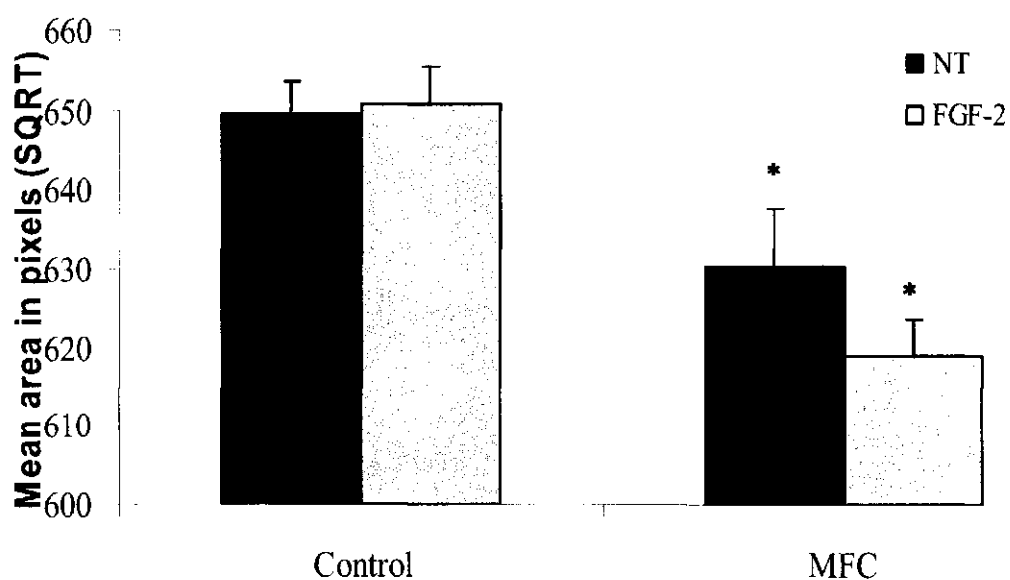

Figure 3-1. Graph of the mean surface area of the dorsal cortex in pixels²

An ANOVA with lesion and treatment as variables showed a main effect of lesion, $F(1,27) = 22.067, p = 0.000$, but no main effect of treatment, $F(1,27) = 0.833, p = 0.370$, nor the interaction, $F(1,27) = 1.357, p = 0.254$. A Fisher's LSD showed that both the untreated and FGF-2 treated MFC lesion rats had significantly smaller cortical SA relative to controls ($p = 0.037$ & $p = 0.001$, respectively). There were no other differences among the groups ($p > 0.100$).

3.3.1.5. Lesion Surface Area

An analysis of lesion surface area (SA) for rats that had received early MFC lesions showed that FGF-2 had no influence on diminishing lesion size in adulthood (see Figure 3-2). A One-way ANOVA showed no differences between the treatment groups, $F(1,19) = 0.172, p = 0.683$.

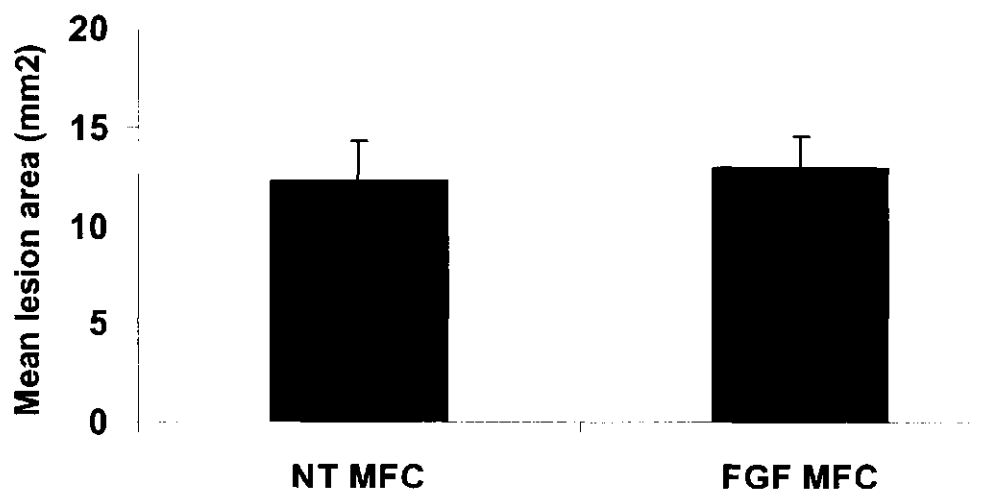

Figure 3-2. Comparison of average lesion size in MFC

3.3.1.6. *Cortical Thickness*

In general, a thinner anterior cortical mantle was found in the medial (Figure 3-3a), lateral (Figure 3-3b), and ventral (Figure 3-3c) cortices of MFC lesion rats, and to a greater extent in FGF-2 treated lesion animals. Yet, FGF-2 had the opposite effect on cortical thickness in controls, as they showed an increase in the posterior planes of the lateral and ventral cortex.

A Repeated Measures ANOVA of the **medial cortex** (Figure 3-3a) showed a main effect of lesion, $F(1,29) = 12.226$, $p = 0.002$, but not of treatment, $F(1,29) = 1.658$, $p = 0.208$, nor the interaction, $F(1,29) = 0.177$, $p = 0.677$. A Fisher's LSD showed a lesion effect only on Plane 3 for both the NT and FGF-2 MFC rats ($p = 0.007$ & $p = 0.011$, respectively), but not on Plane 4, nor Plane 5 (p 's > 0.100), relative to controls. There was, however, a marginal increase of cortical thickness for the FGF-2 treated lesion rats on Plane 4 ($p = 0.076$) relative to the untreated lesion animals.

A Repeated Measures ANOVA of **lateral cortex** (Figure 3-3b) showed a main effect of lesion, $F(1,29) = 16.456$, $p = 0.000$, but no main effect of treatment, $F(1,29) = 1.809$, $p = 0.189$, nor interaction, $F(1,29) = 0.129$, $p = 0.722$. A Fisher's LSD showed a significantly thinner cortex on Planes 1 -3 for both the NT MFC ($p = 0.029$, $p = 0.008$, & $p = 0.013$, respectively) and the FGF-2 MFC rats ($p = 0.003$, $p = 0.048$, & $p = 0.015$, respectively), but no difference in cortical thickness for lesion rats on Planes 4 -5, relative to controls (p 's > 0.100). Interestingly, FGF-2 showed an increase of cortical thickness for controls on Plane 4 ($p = 0.003$) and a trend on Plane 5 ($p = 0.080$).

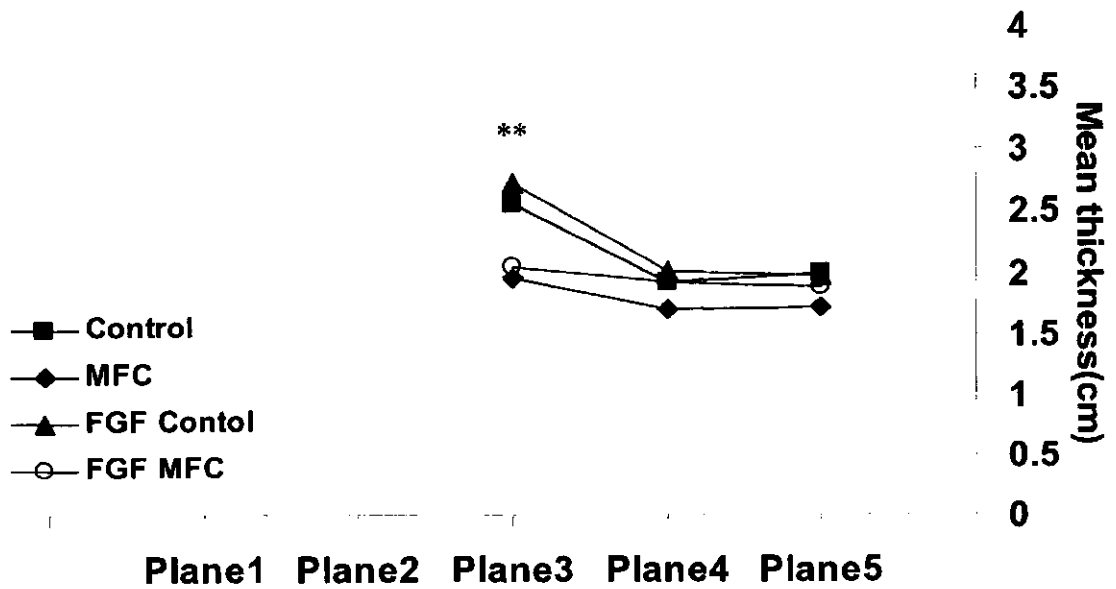

Figure 3-3a Medial Cortex

- * significant difference between MFC lesion rats and controls
- * significant difference between FGF-2 MFC lesion rats and controls

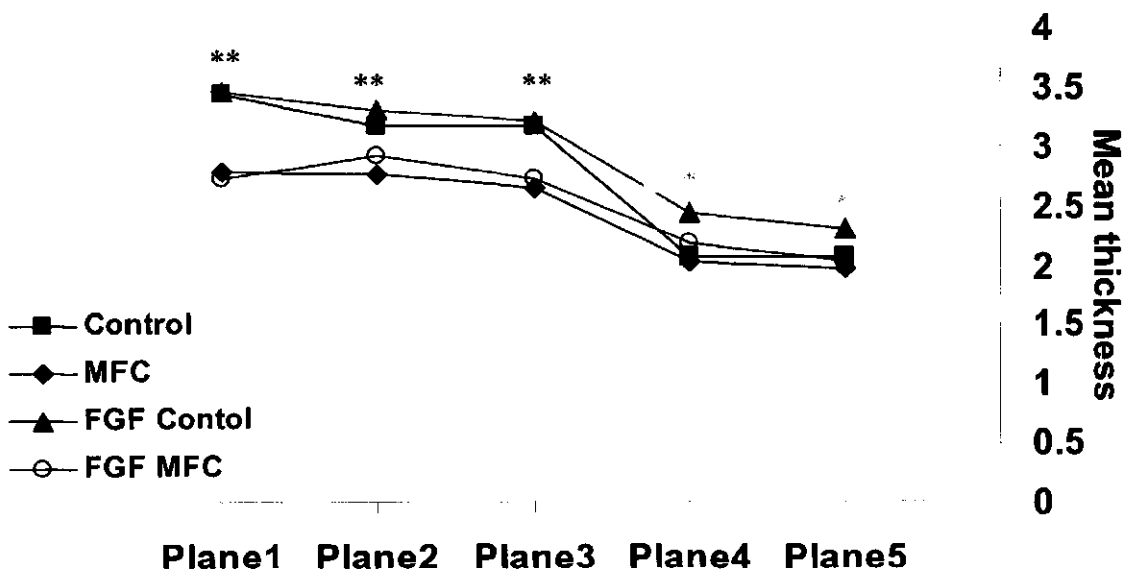

Figure 3-3b Lateral Cortex

- * significant difference between NT MFC and controls
- * significant difference between FGF-2 MFC and controls
- * significant difference between FGF-2 controls and NT controls

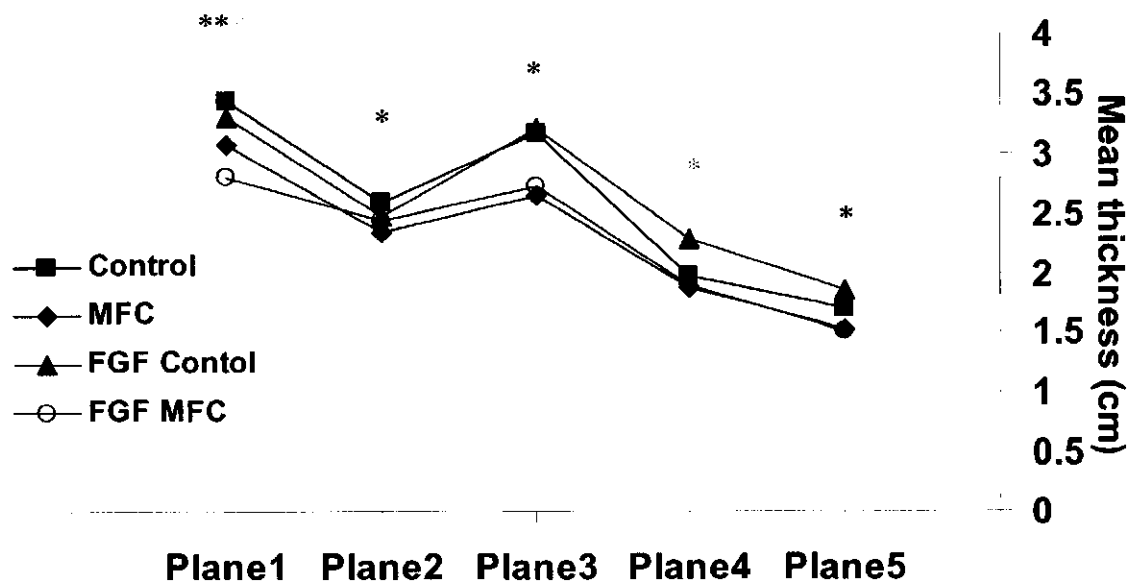

Figure 3-3c Ventral Cortex

- * significant difference between NT MFC and controls
- * significant difference between FGF-2 MFC and controls
- * significant difference between FGF-2 controls and NT controls
- ** significant difference between FGF-2 MFC and NT MFC

Figure 3-3. Graphs depicting mean cortical thickness on five different planes for three different cortical areas (a) medial cortex, (b) lateral cortex, (c) ventral cortex.

A Repeated Measures ANOVA of ventral cortex (Figure 3-3c) showed a main effect of lesion, $F(1,33) = 17.929$, $p = 0.000$, but not treatment, $F(1,33) = 0.161$, $p = 0.691$, nor the interaction, $F(1,33) = 0.228$, $p = 0.636$. A Fisher's LSD showed that the untreated lesion rats had significantly thinner cortices on Planes 1 -2 and a marginally thinner cortex on Plane 3 ($p = 0.024$, $p = 0.033$, & $p = 0.072$, respectively), whereas FGF-2 treated lesion rats showed a thinner cortex on Plane 1 relative to both the controls and the untreated MFC rats ($p = 0.000$, $p = 0.030$, respectively) and on Plane 5 ($p = 0.053$) relative to controls. In contrast, FGF-2 treated controls showed an increase in ventral

cortical thickness relative to untreated controls, although it was restricted to Plane 4 ($p = 0.039$).

3.3.1.7. Anterior and Posterior Thalamic Cross-sectional Area

The anterior thalamic cross-sectional area was smaller in rats with P3 lesions of the MFC (see Table 3-4). Rats that had been treated with FGF-2 also had smaller anterior thalamic measurements relative to controls, independent of whether they had received a lesion. The posterior thalamus was also shrunken in lesion rats but, in contrast to the anterior thalamus, was not influenced by FGF-2 treatment.

Table 3-4 Summary of measurements of anterior thalamus and brainstem cross-sectional areas

Mean Thalamic Cross-sectional area (mm ²)		
Group	Anterior	Posterior
NT Controls	18.37 ± 0.64	30.11 ± 1.05
FGF-2 Controls	17.22 ± 0.29*	29.17 ± 0.56
NT MFC	14.39 ± 0.36**	27.48 ± 0.77*
FGF-2 MFC	14.53 ± 0.27**	26.84 ± 0.53*

* significantly different from Controls at $p \leq 0.05$

** significantly different from Controls at $p \leq 0.001$

An ANOVA of anterior thalamic cross-sectional area with lesion and treatment as variables revealed a significant main effect of lesion, $F(1,33) = 76.23$, $p = 0.000$, but no main effect of treatment, $F(1,33) = 1.755$, $p = 0.194$, nor the interaction, $F(1,33) = 2.88$, $p = 0.099$. As well, an ANOVA of brainstem measurements with group and treatment as variables showed a significant main effect of lesion, $F(1,34) = 11.33$, $p = 0.002$, but no

main effect of treatment $F(1,34) = 1.156, p = 0.290$, nor interaction, $F(1,34) = 0.041, p = 0.840$.

A Fisher's LSD tests showed that both the thalamic cross-sectional areas and brain stem area were significantly smaller in the NT MFC rats ($p = 0.000$ & $p = 0.041$, respectively), and in the FGF-2 MFC rats ($p = 0.000$ & $p = 0.004$, respectively), relative to controls. The anterior thalamus, but not the brain stem was smaller in FGF-2 controls relative to NT controls ($p = 0.051$ & $p = 0.399$, respectively).

3.3.2. BEHAVIORAL RESULTS

3.3.2.1. Morris Water Maze

In the current experiment, the MFC animals had difficulty acquiring the task and, with the exception of trial block 3, remained impaired relative to controls throughout testing (see Figure 3-4). Overall, MFC lesion rats that received FGF-2 performed the task better than the untreated MFC animals (see Figure 3-5) and showed no significant impairment relative to controls. No difference was found between the untreated and treated sham lesion controls.

An ANOVA of the total mean daily latencies over the seven trial blocks showed a main effect of lesion, $F(1,52) = 16.01, p = 0.000$, but no main effect of treatment, $F(1,53) = 2.76, p = 0.103$, nor the interaction, $F(1,53) = 2.168, p = 0.147$. A LSD test revealed, that the NT MFC rats were significantly impaired at the task relative to both the controls and the FGF-2 treated MFC rats ($p = 0.000$ & $p = 0.023$, respectively). There was no significant difference between the FGF-2 MFC rats and the controls ($p = 0.098$).

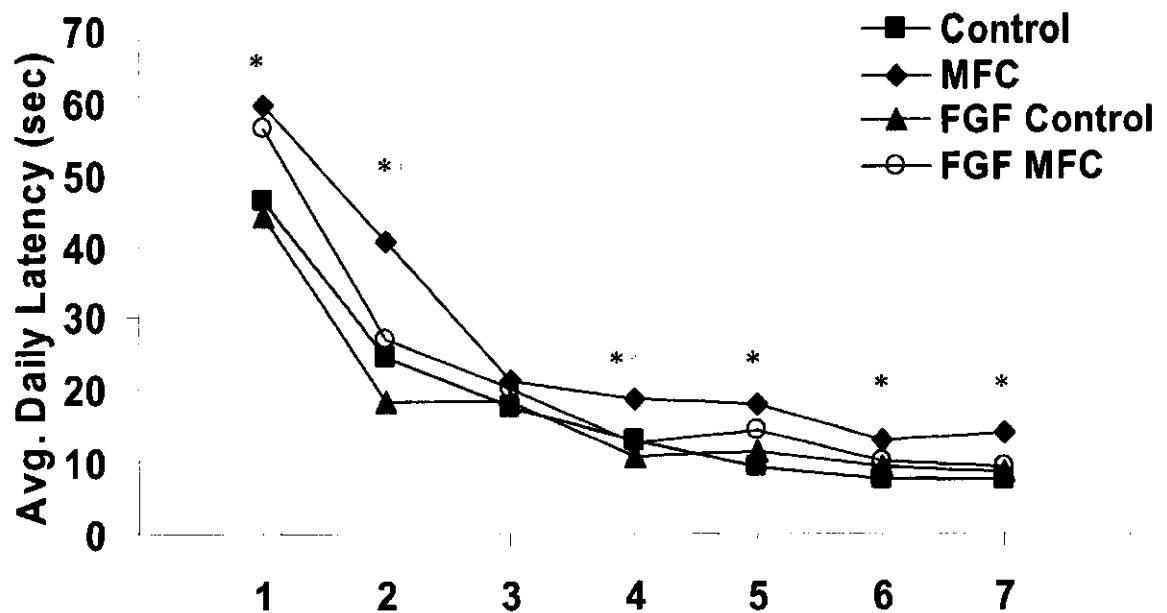

* significant difference between NT MFC and controls
 * significant difference between FGF-2 MFC and NT MFC

Figure 3-4 Graph of the average latency per day (trial block)

A Fisher's LSD post hoc analysis with a Repeated Measures ANOVA of average daily latencies showed that the NT MFC rats were impaired on all seven days relative to controls with the exception of Day 3, ($p = 0.026$, $p = 0.009$, $p = 0.507$, $p = 0.062$, $p = 0.044$, $p = 0.015$, $p = 0.028$). In contrast, the FGF-2 treated MFC rats showed only a trend towards an impairment on Day 1 ($p = 0.80$), but no significant impairment in performance on any other day (p 's > 0.100). Further, FGF-2 MFC rats performed significantly better than their untreated counterparts on Day 2, 4 ($p = 0.012$ & $p = 0.027$) and a marginal improvement over the NT MFC rats on Day 6 as well ($p = 0.072$).

The performance of MFC animals was not related to swim speed. An ANOVA showed no difference between groups. There was no main effect of lesion, $F(1,52) = 0.032$, $p = 0.858$, nor treatment, $F(1,52) = 0.002$, $p = 0.969$, and no interaction, $F(1,52) = 0.739$, $p = 0.394$ (see Figure 3-6).

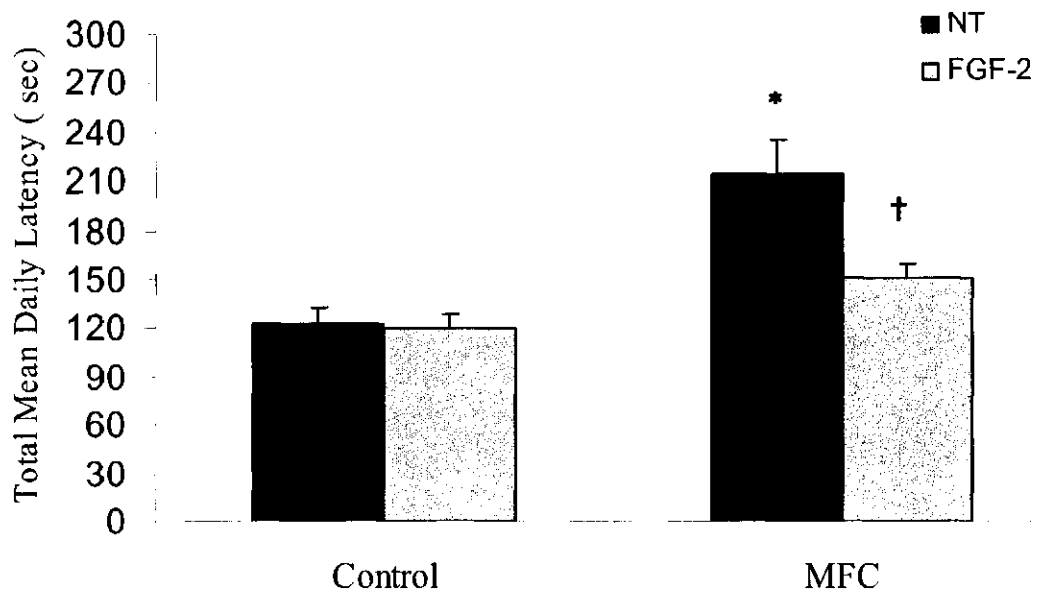

* significantly different from NT Controls at $p \leq 0.001$
 † significantly different from NT MFC group $p \leq 0.05$

Figure 3-5. Sum of mean latencies over 7 trial blocks

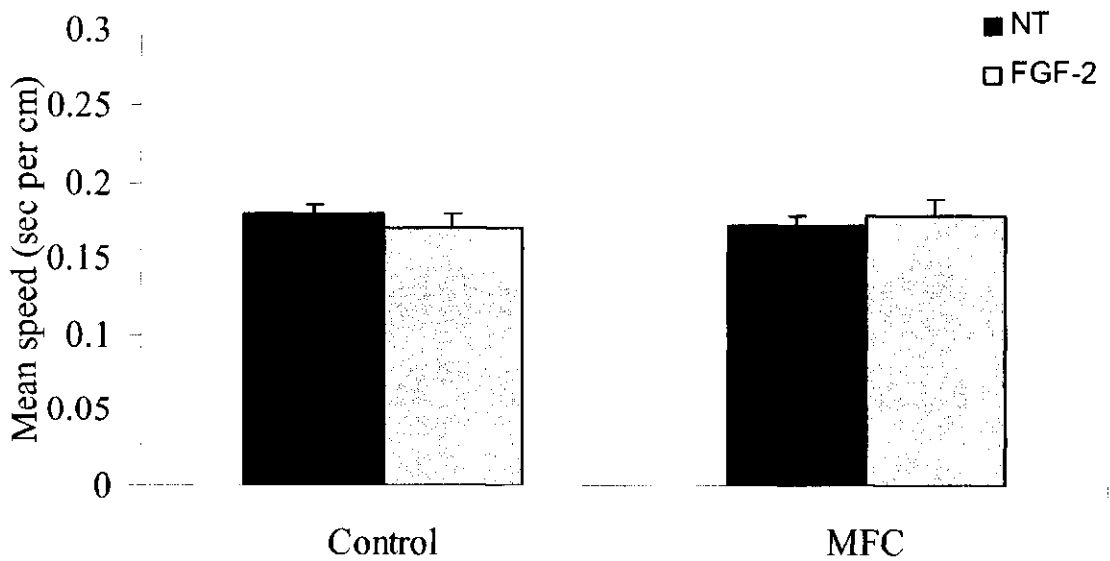
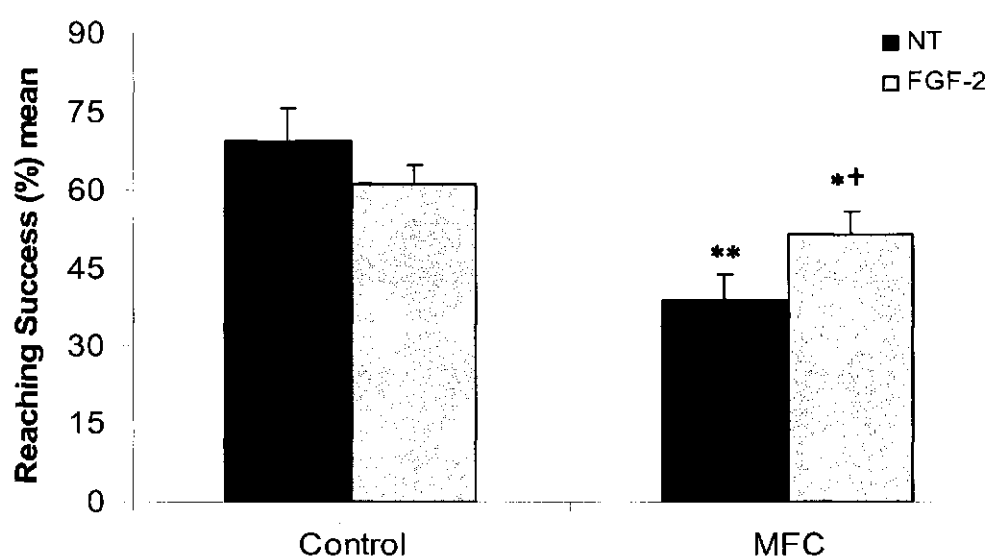

Figure 3-6 Summary of mean swim speed (sec per cm)

3.3.2.2. *Whishaw Tray Reaching Task*

Rats with MFC lesions were impaired at the reaching task relative to controls. Treatment with FGF-2 did not eliminate the deficit but reduced the impairment, as the FGF-2 MFC group had a greater reaching success than the NT MFC rats (see Figure 3-7). FGF -2 sham lesion rats, on the other hand, showed a slight decline in reaching success although it was not significant.

An ANOVA with lesion and treatment as variables revealed a main effect of lesion, $F(1,49) = 20.43$, $p = 0.000$, but no main effect of treatment, $F(1,49) = 0.525$, $p = 0.472$. There was, however, an interaction of lesion and treatment, $F(1,49) = 4.08$, $p = 0.049$. Although a Fisher's LSD test showed a significant impairment in reaching for both the NT MFC group ($p = 0.000$) and the FGF-2 MFC group ($p = 0.009$) relative to controls, FGF-2 MFC rats were significantly better at the task than the untreated MFC rats ($p = 0.046$).



* significantly different from NT Controls at $p \leq 0.05$

** significantly different than the NT Controls at $p \leq 0.001$

† significantly different than the NT MFC rats at $p \leq 0.05$

Figure 3-7. Summary of reaching success in percentages

3.3.2.3. Open Field Test

The only significant finding in the level of activity was that the females were more active than the males (see Table 3-5). An ANOVA with sex, treatment and lesion as variables showed a main effect of sex, $F(1,34) = 9.707$, $p = 0.004$, but no effect of treatment, $F(1,34) = 0.039$, $p = 0.845$, nor lesion, $F(1,34) = 0.215$, $p = 0.645$. There were no significant interactions, p 's > 0.10 .

Table 3-5. Mean distance, horizontal, vertical, and number of movements.

Group	Activity Level (averaged)	
	NT	FGF-2
Control	459.52 ± 28.63	431.01 ± 34.18
MFC	435.64 ± 43.07	422.55 ± 37.79

Experiment 2.2 Posterior Parietal Cortical Lesions

3.3.3. ANATOMICAL RESULTS

3.3.3.1. Body Weight

Body weights were analyzed separately for each sex. Results of both the male and female analyses showed that lesions of the PPC did not have an effect on body weight in adulthood. Rats of both sexes that were treated with FGF-2 following PPC lesions, had a lighter body weight relative to the same-sex controls (see Table 3-6). An ANOVA of males with lesion and treatment as variables showed a main effect of lesion, $F(1,21) = 6.25, p = 0.021$, but no main effect of treatment, $F(1,21) = 0.811, p = 0.378$, nor the interaction, $F(1,21) = 0.022, p = 0.883$. An ANOVA of females showed only a marginally significant main effect of lesion, $F(1,26) = 3.95, p = 0.057$, and no main effect of treatment, $F(1,26) = 3.48, p = 0.73$, nor an interaction of group and treatment, $F(1,26) = 0.152, p = 0.700$.

Table 3-6. Summary of mean body weights in grams

Group	Body Weight (grams)	
	Male	Female
NT Control	436 ± 34	302 ± 14
FGF-2 Control	419 ± 26	278 ± 8
NT PPC	382 ± 21	276 ± 7
FGF-2 PPC	358 ± 11*	260 ± 10*

* significantly different than NT Controls at $p \leq .05$

Fisher's LSD tests showed that the only significant differences in body weight for both males and females was a reduction in weight of the FGF-2 groups relative to controls ($p = 0.025$ & $p = 0.009$, respectively).

3.3.3.2. Brain Weight

Sexes were analyzed separately. Lesions of PPC resulted in lighter brain weights for both sexes, whether or not they had received FGF-2 treatment (see Table 3-7). Rather than FGF-2 enhancing brain weight, treated lesion rats had lighter brains than even the untreated lesion rats. Further, FGF-2 affected brain weight in controls as well, but this affect was dependent on sex.

An ANOVA of male brain weight with lesion and treatment as variables showed a main effect of lesion, $F(1,22) = 83.508$, $p = 0.000$, and treatment, $F(1,22) = 24.377$, $p = 0.000$, but not the interaction, $F(1,22) = 1.535$, $p = 0.228$. An ANOVA of females showed a main effect of lesion, $F(1,24) = 36.027$, $p = 0.000$, and a marginal interaction, $F(1,24) = 3.955$, $p = 0.058$, but no main effect of treatment, $F(1,24) = 1.68$, $p = 0.207$.

Table 3-7 Summary of mean brain weights in grams

Brain Weight (grams)		
Group	Male	Female
NT Control	1.75 ± .02	1.54 ± .04
FGF-2 Control	1.60 ± .01*	1.56 ± .03
NT PPC	1.49 ± .03*	1.41 ± .04*
FGF-2 PPC	1.40 ± .03*†	1.31 ± .03*†

* significantly different than NT Controls at $\leq .05$

† significantly different than NT Controls at $\leq .001$

Fisher's LSD's performed separately for each sex revealed some interesting results. Both treated and untreated males with PPC lesions had significantly lighter brains relative to controls ($p = 0.000$ & $p = 0.000$, respectively), as did the females ($p = 0.010$ & $p = 0.000$, respectively). Further, FGF-2 treatment actually reduced the brain weight relative to untreated lesion rats in both males and females ($p = 0.009$ & $p = 0.015$, respectively). As well, there was a differential sex effect of FGF-2 on controls as only males treated with FGF-2 had significantly lighter brains relative to untreated controls ($p = 0.009$), whereas the females did not ($p = 0.661$).

3.3.3.3. *Cerebellum SA*

Lesions of the PPC did not have an effect on cerebellum surface area (SA). As well, no differences were found among groups, whether or not they had received FGF-2 treatment (see Table 3-8). A sex difference was found but as it was across groups, sexes were collapsed.

Table 3-8. *A summary of the mean dorsal surface area of the cerebellum in pixels².*

Cerebellum SA (pixels ²)		
Group	NT	FGF-2
Control	352.04 ± 6.57	354.05 ± 1.90
PPC	357.33 ± 5.59	361.60 ± 3.06

An ANOVA with lesion, treatment, and sex as variables showed a main effect of sex $F(1,32) = 10.487$, $p = 0.003$, but no main effect of lesion, $F(1,32) = 2.435$, $p = 0.128$,

nor treatment, $F(1,32) = 0.198$, $p = 0.659$. There were no interactions (p 's > 0.100). A Tukey's post hoc test revealed no differences among the groups (p 's > 0.500).

3.3.3.4. Cortical SA

Rats with PPC lesions had significantly smaller dorsal cortical surface areas (SA) relative to controls (see Figure 3-8). This effect was exasperated in lesion rats with FGF-2 treatment. FGF-2 did not, however, have an affect on cortical surface area of controls.

An ANOVA with lesion and treatment as variables showed a main effect of lesion, $F(1,30) = 63.576$, $p = 0.000$, a marginal interaction, $F(1,30) = 3.992$, $p = 0.055$, but no main effect of treatment, $F(1,30) = 3.046$, $p = 0.091$. A Fisher's LSD showed that both NT PPC and FGF-2 PPC had significantly smaller cortical surface areas relative to controls ($p = 0.001$ & $p = 0.000$, respectively). As well, it showed a significantly smaller cortex in lesion rats that had been treated ($p = 0.006$) relative to the untreated lesion rats.

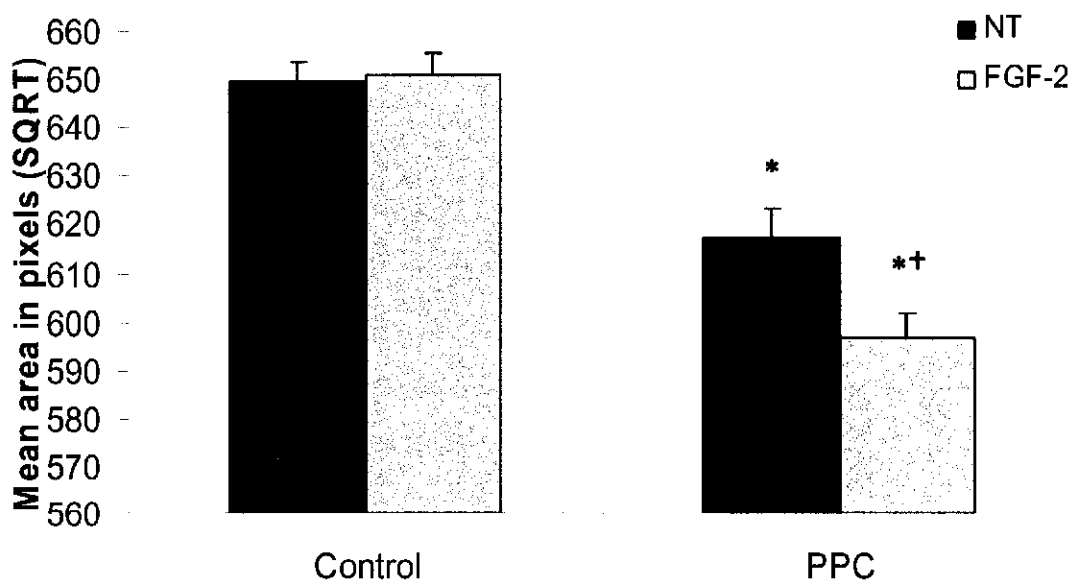

** significantly different from controls at $p \leq 0.001$

† significantly different from NT PPC rats at $p \leq 0.05$

Figure 3-8. Chart of the mean dorsal cortical surface area (pixels²).

3.3.3.5. Cortical Thickness.

In general, lesions of the PPC caused a decrease in the medial cortex (Figure 3-9a) of planes anterior to the approximate original lesion site (Plane 4). Treatment with FGF-2 increased the extent of cortical thinning in the lesion rats as there was a decrease in the lateral (Figure 3-9b) and ventral (Figure 3-9c) cortices in lesion rats relative to the untreated lesion animals. In contrast, controls treated with FGF-2 showed an increase in cortical thickness on Plane 4 of both the lateral and ventral cortex relative to controls.

A Repeated Measures ANOVA of the **medial cortex** (Figure 3-9a) with lesion and treatment as variables showed a main effect of lesion, $F(1,33) = 27.457, p = 0.000$, but no main effect of treatment, $F(1,33) = 0.001, p = 0.975$, nor an interaction, $F(1,33) = 0.528, p = 0.472$. A Fisher's LSD showed no group differences on Plane 1 (p 's > 0.05), but a significant main effect of treatment, $F(1,33) = 0.001, p = 0.975$, nor an interaction, $F(1,33) = 0.528, p = 0.472$. A Fisher's LSD showed no group differences on Plane 1 (p 's > 0.05), but a significant reduction of the medial cortex on Plane 2 and 3, and a trend in reduction for Plane 5 in untreated PPC lesion rats ($p = 0.000$ & $p = 0.001$, respectively). Similarly, FGF-2 treated lesion rats had a significant decrease in cortical thickness on Planes 2 - 3 and Plane 5 ($p = 0.000$ & $p = 0.002$, & $p = 0.016$, respectively). There were no other differences among groups on the remaining planes (p 's > 0.05).

A Repeated Measures of the **lateral cortex** (Figure 3-9b) showed a main effect of lesion, $F(1,34) = 40.138, p = 0.000$, and an interaction of lesion and treatment, $F(1,34) = 4.94, p = 0.033$, but no main effect of treatment itself, $F(1,34) = 0.000, p = 0.998$. A Fisher's LSD showed that untreated PPC rats continued to have a decrease in cortical thickness of the lateral cortex on Planes 2 -3 ($p = 0.004$ & $p = 0.055$, respectively),

whereas the lateral cortex of FGF-2 treated lesion rats was now thinner on Plane 1, as well as Planes 2 – 3 ($p = 0.009$, $p = 0.000$ & $p = 0.000$, respectively). Further, Plane 3 of the FGF-2 lesion rats was now significantly thinner than even the untreated lesion animals ($p = 0.006$). Yet, FGF-2 treatment resulted in an increase on Plane 4 for the control rats ($p = 0.031$) relative to the controls.

A Repeated-measures ANOVA of **ventral cortex** (Figure 3-9c) with lesion and treatment as variables showed an overall significant main effect of lesion, $F(1,37) = 15.083$, $p = 0.000$, but no main effect of treatment, $F(1,37) = 0.499$, $p = 0.484$. There was a marginally significant interaction of lesion and treatment, however, $F(1,37) = 3.668$, $p = 0.063$. A Fisher's LSD showed that the ventral cortex of the untreated PPC rats was only thinner on Plane 2 relative to controls ($p = 0.049$), whereas the FGF-2 PPC rats continued to show a thinner cortex on Planes 1 – 3 ($p = 0.004$, $p = 0.015$ & $p = 0.020$, respectively), and although the ventral cortex was not thinner on Plane 4 relative to controls ($p = 0.281$), it was significantly thinner than the untreated lesion rats ($p = 0.006$). In contrast, FGF-2 treated controls had a significantly thicker cortical mantle on Plane 4 relative to untreated controls ($p = 0.025$).

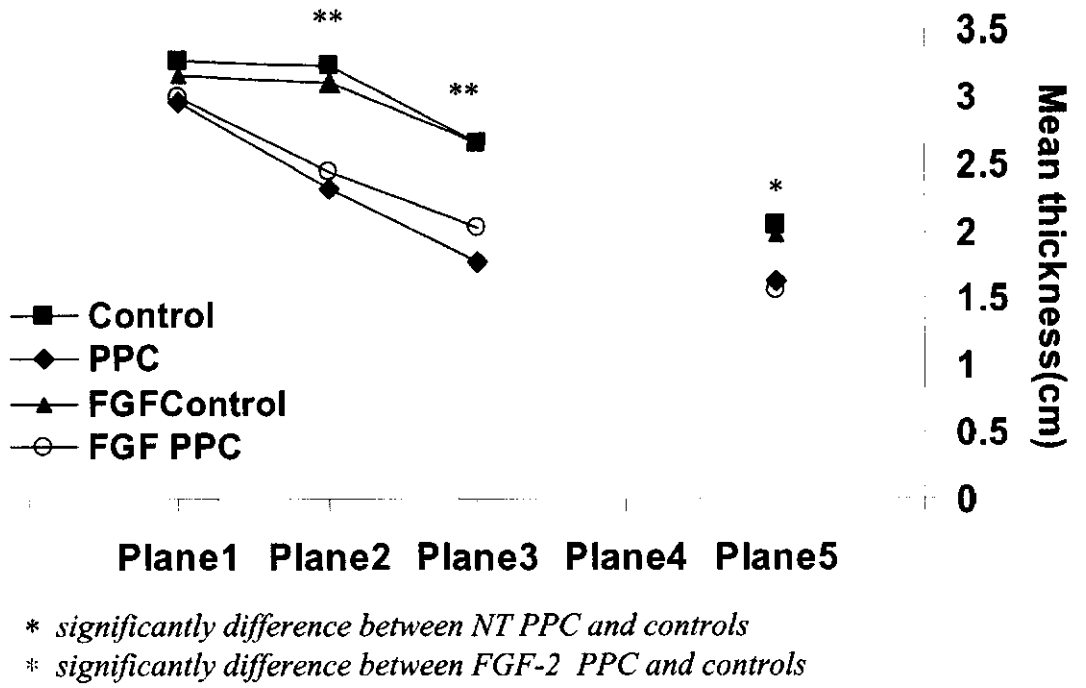

Figure 3-9a Medial Cortex

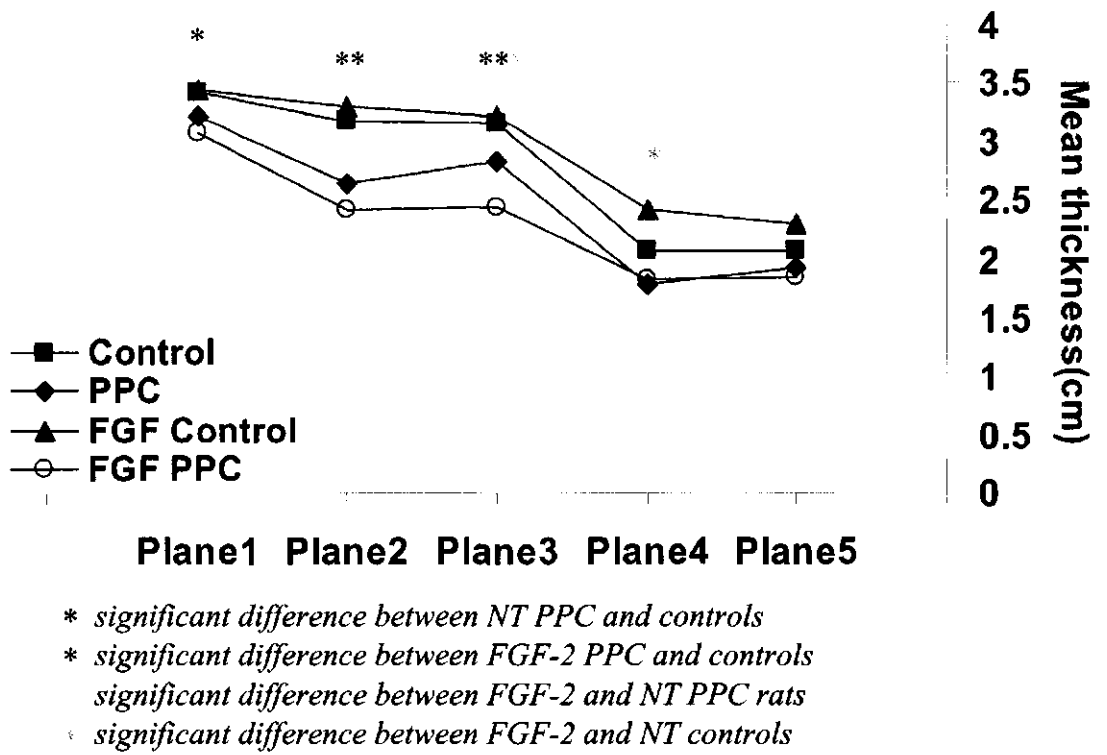
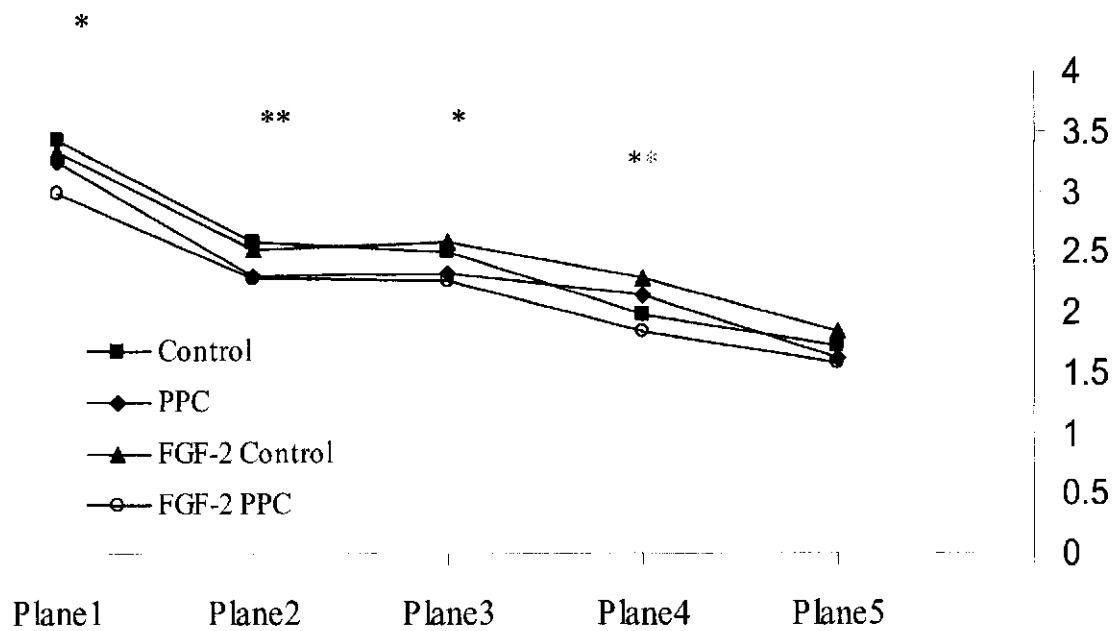

Figure 3-9b Lateral Cortex



- * significant difference between NT PPC and controls
- * significant difference between FGF-2 PPC and controls
- * significant difference between FGF-2 and NT PPC rats
- * significant difference between FGF-2 and NT controls

Figure 3-9c Ventral Cortex

Figure 3-9 Graphs depicting mean cortical thickness on five different planes for three different cortical areas (a) medial cortex, (b) lateral cortex, (c) ventral cortex.

3.3.3.6. Anterior and Posterior Thalamic Cross-sectional Area

Rats with lesions of the PPC had a shrunken anterior thalamus, whether or not they had been treated with FGF-2 (see Table 3-9). Cross-sectional area of the posterior thalamus, on the other hand, did not differ among groups.

Table 3-9. Summary of mean anterior thalamus and brainstem

Mean Cross-sectional Area (mm ²)		
Group	Thalamus	Brain stem
NT Controls	18.57 ± 0.64	30.11 ± 1.05
FGF-2 Controls	17.20 ± 1.11	28.80 ± 0.99
NT PPC	14.63 ± 0.74*	31.94 ± .081
FGF-2 PPC	14.64 ± 0.84*	29.48 ± .85

* significantly different from NT Controls at $p \leq .05$

An ANOVA of anterior thalamic cross-sections with lesion and treatment as variables revealed a significant main effect of lesion, $F(1,33) = 38.18, p = 0.000$, but no main effect of treatment, $F(1,33) = 2.715, p = 0.109$, nor the interaction, $F(1,33) = 0.137, p = 0.713$. An ANOVA of posterior thalamic area revealed only a trend for lesion effect, $F(1,36) = 3.54, p = 0.068$ (PPC < Controls), and no main effect of treatment, $F(1,36) = 2.568, p = 0.118$, nor the interaction, $F(1,36) = 0.358, p = 0.553$.

3.3.3.7. Lateral Posterior Thalamic Nuclei (LP)

As shown in Figures 3-10a and 3-11a, the lateral posterior thalamic nuclei (LP) is located in the dorsal area of the posterior thalamus. Relative to controls, the LP was either missing or indistinguishable due to an overall disorganization of the thalamus at this point (see Figures 3-12a – 3-13a). The dorsal area of the LP or ‘shoulders’, are no longer present following PPC lesions, whether or not the rat had received FGF-2 treatment. The neuronal population in the general area of the thalamus that would normally represent the LP appeared to be more densely populated in treated PPC lesion

rats relative to the untreated lesion rats. This was only a speculative observation however, as owing to the inability to discern the exact location of the LP no quantification of cell numbers was performed. No observable differences in the organization of the LP were found in FGF-2 treated controls relative to the untreated controls.

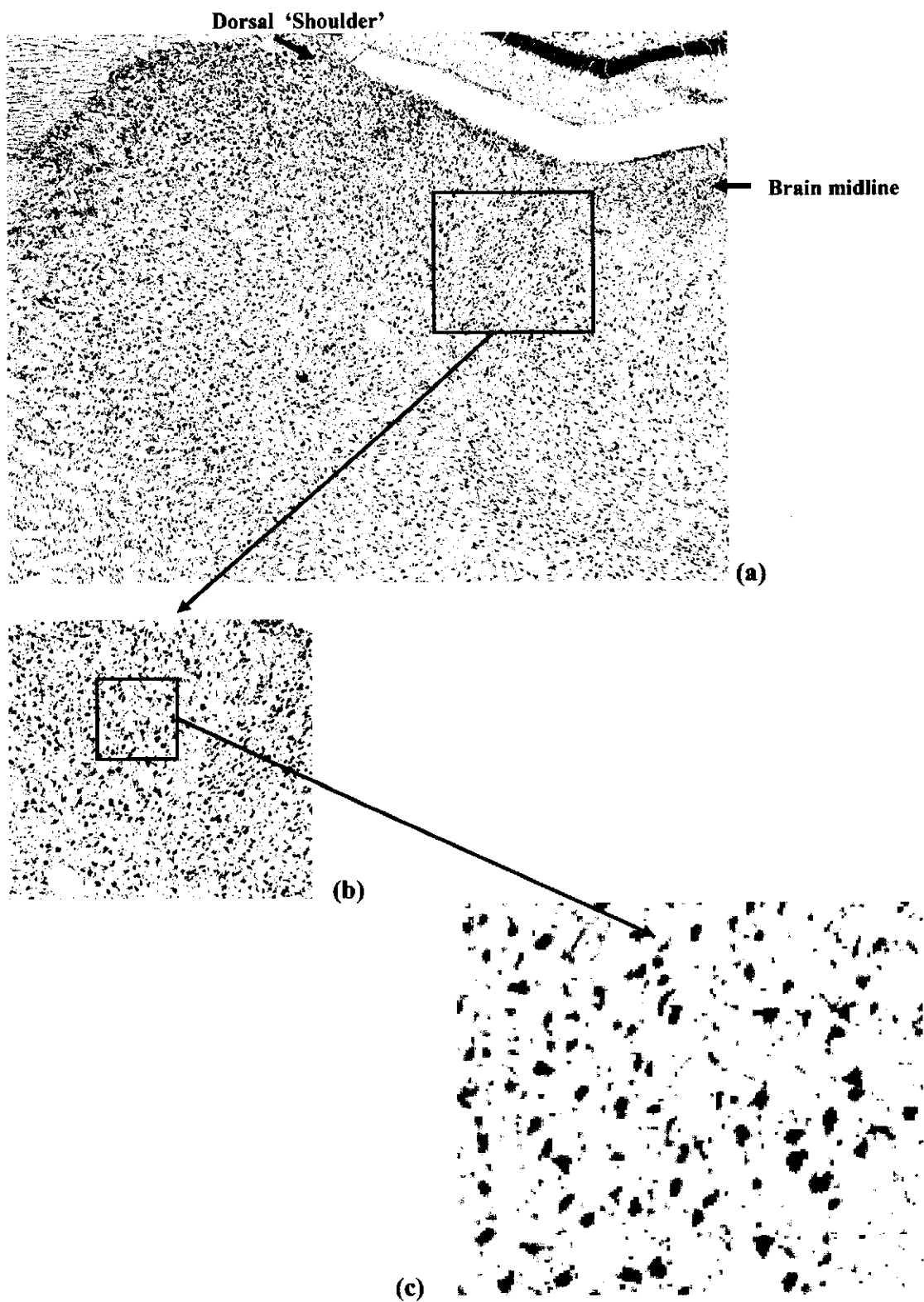

Figure 3-10 *NT Control (a) The LP of a treated rat magnified to 5X (b) excerpt of above magnified (200X) to illustrate cell organization within the LP, and (c) an enlarged excerpt to illustrate cell form and type*

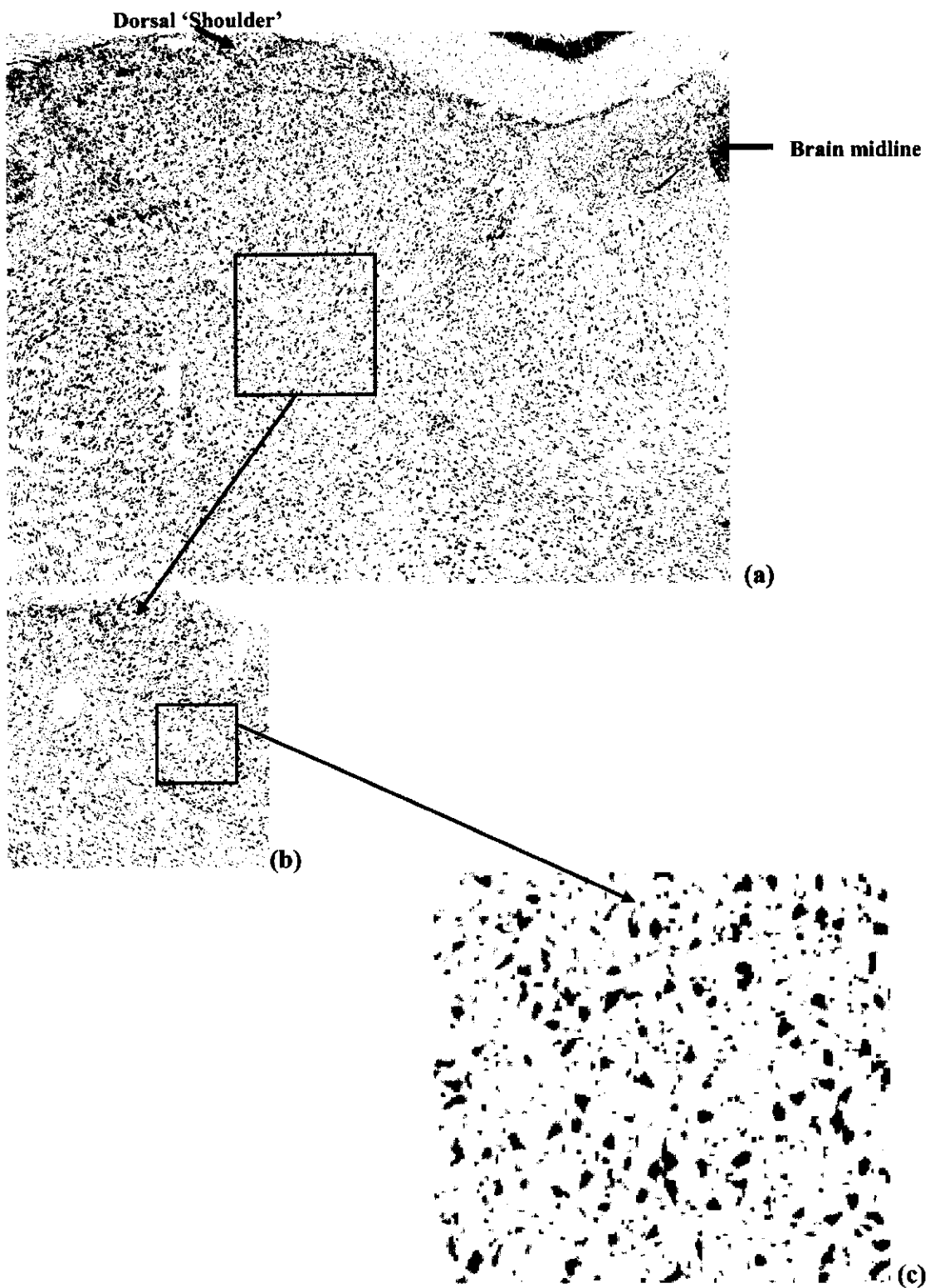

Figure 3-11 *FGF-2 Control (a) The LP of a treated rat magnified to 5X (b) excerpt of above magnified (200X) to illustrate cell organization within the LP, and (c) an enlarged excerpt to illustrate cell form and type*

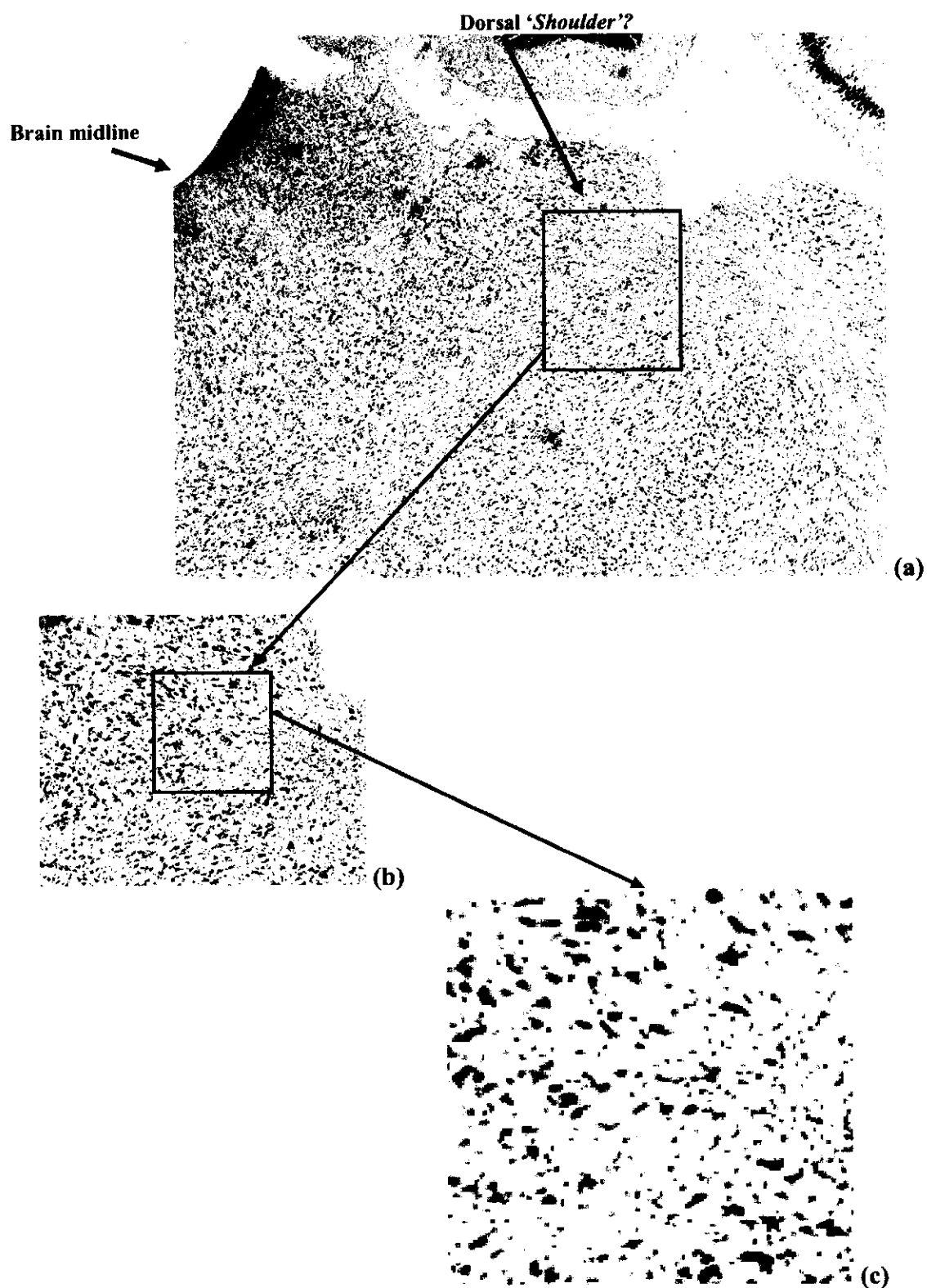

Figure 3-12 *NT PPC (a) The LP of a treated rat magnified to 5X (b) excerpt of above magnified (200X) to illustrate cell organization within the LP, and (c) an enlarged excerpt to illustrate cell form and type*

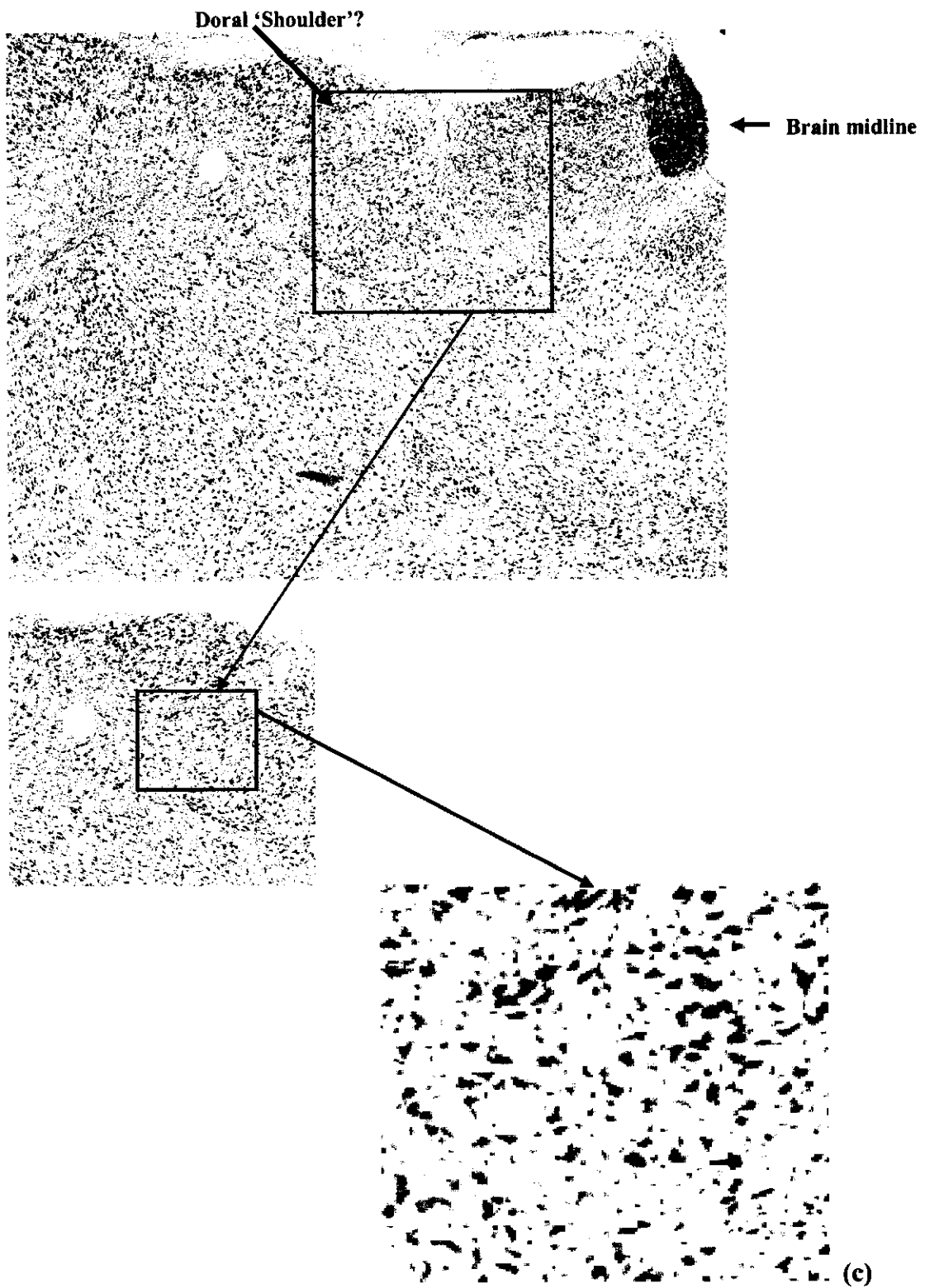

Figure 3-13 *FGF-2 PPC (a) The LP of a treated rat magnified to 5X (b) excerpt of above magnified (200X) to illustrate cell organization within the LP, and (c) an enlarged excerpt to illustrate cell form and type*

3.3.4. BEHAVIORAL RESULTS

3.3.4.1. Morris Water Maze

Rats with lesions of the PPC were impaired at the water task, as were FGF-2 PPC rats. FGF-2 treatment did improve the performance of the PPC rats, however, in that they were better at the task than the untreated lesion animals (see Figure 3-14). Overall, the FGF-2 PPC group had a lower sum of average latencies over the seven trial blocks when compared to the NT PPC rats

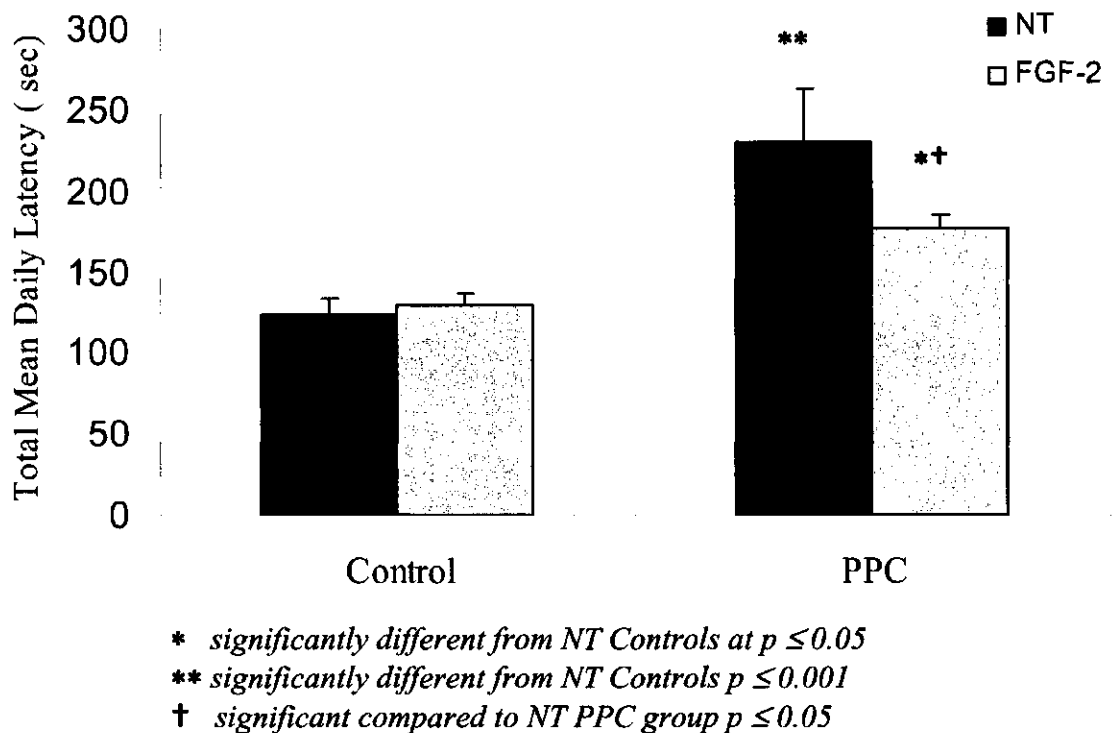

Figure 3-14. Sum of mean latencies for 7 trial blocks

Although both lesion groups started out impaired relative to the control groups, the FGF-2 treated PPC rats acquired the task rather quickly relative to the untreated lesion rats, reaching asymptote by about the fourth trial block (see Figure 3-15). As the controls

continued to improve, however, the initial impairment was evident again by Day 6, showing that the FGF-2 PPC never attained the same level in performance as the controls.

The data were transformed using a square-root transformation to reduce variance. An ANOVA with lesion and treatment as variables showed a significant main effect of lesion, $F(1,53) = 27.57, p = 0.000$, but no main effect of treatment, $F(1,53) = 1.63, p = 0.207$, nor the interaction, $F(1,53) = 1.773, p = 0.189$. A Fisher's LSD test showed a significant impairment in the NT PPC group relative to controls ($p = .000$). Although the FGF-2 PPC rats showed a significant improvement over the NT PPC rats, ($p = .05$), their improved performance failed to eliminate the deficit in latency relative to NT Controls ($p = .006$).

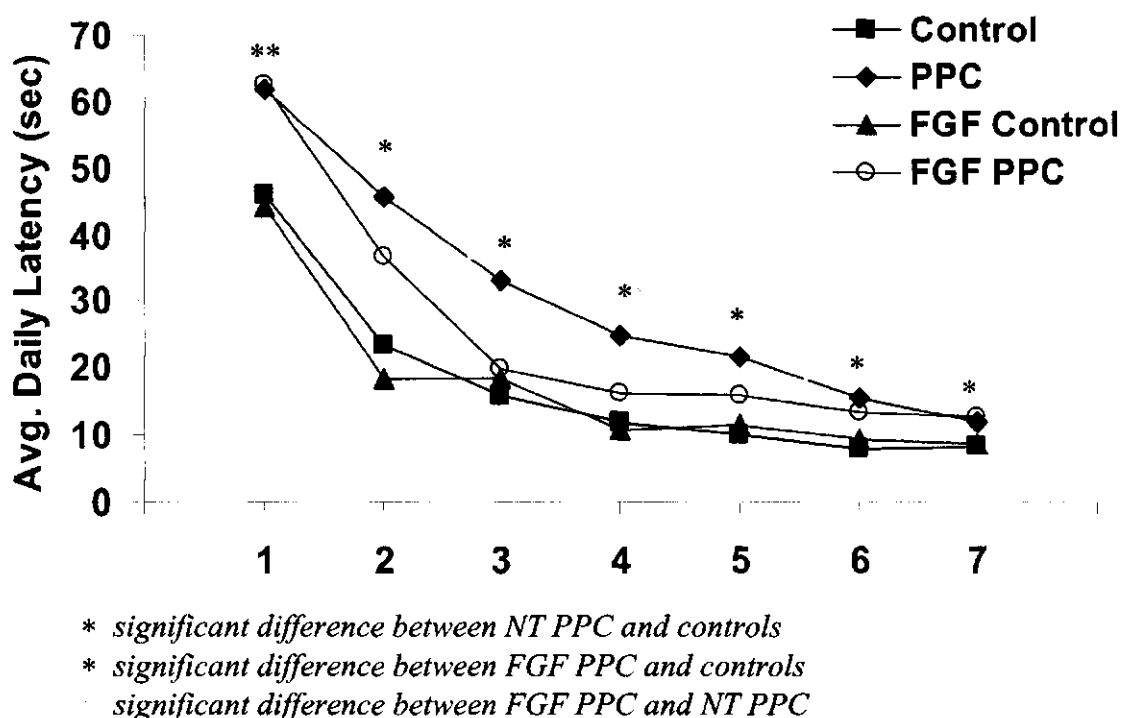
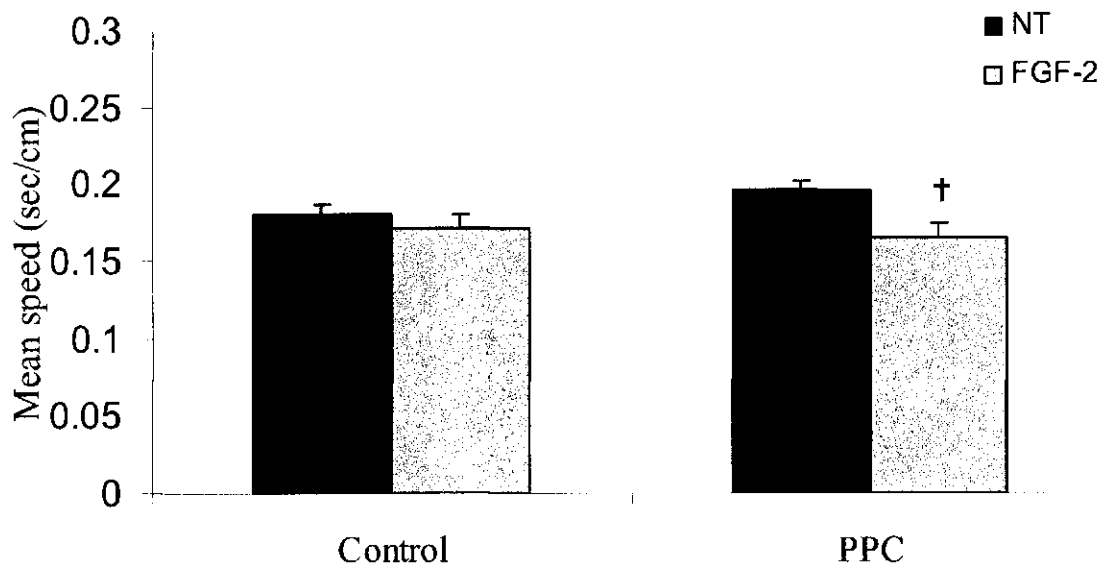

Figure 3-15. Graph of the average latency per day (trial block)

A Fisher's LSD post hoc analysis performed on a Repeated Measures ANOVA of the average daily latencies showed that NT PPC rats were impaired at the task on every day, with the exception of Day 7 where they showed only a trend in impairment relative to controls ($p = 0.024$, $p = 0.003$, $p = 0.006$, $p = 0.002$, $p = 0.004$, $p = 0.005$, $p = 0.074$, respectively). In contrast, the FGF-2 PPC rats were significantly impaired on Day 1 and 7 only, with a marginally significant impairment on Day 6 and, a trend on Day 2 relative to controls ($p = 0.019$, $p = 0.073$, $p = 0.511$, $p = 0.290$, $p = 0.117$, $p = 0.049$, $p = 0.039$, respectively). Further, the FGF-2 PPC rats showed a significant improvement in performance relative to the untreated lesion rats on Day 3 and 4 ($p = 0.023$, $p = 0.024$, respectively). There were no other significant differences among the groups (p 's > 0.100).

An analysis of swim speed showed that the difference among any of the groups was not an outcome of difference in swim speed. In fact, the treated lesion rats had a slightly slower average swim speed (see Figure 3-16), although they took less time in finding the platform. An ANOVA of swim speed showed a main effect of treatment, $F(1,51) = 7.07$, $p = 0.010$, but no main effect of lesion, $F(1,51) = 0.342$, $p = 0.561$, nor the interaction $F(1,51) = 2.06$, $p = 0.157$.



† significantly different from NT PPC at $p \leq 0.05$

Figure 3-16 Summary of swim speed (sec/cm)

3.3.4.2. *Whishaw Tray Reaching Task*

Animals in the NT PPC and FGF-2 PPC groups showed no impairment in the reaching task. The percentage of successful reaches for food pellets was comparable across groups (see Figure 3-17). An ANOVA with lesion and treatment as variables showed no main effect of lesion, $F(1,50) = 1.66$, $p = 0.203$, nor treatment, $F(1,50) = 0.076$, $p = 0.783$, or interaction $F(1,50) = 1.424$, $p = 1.424$.

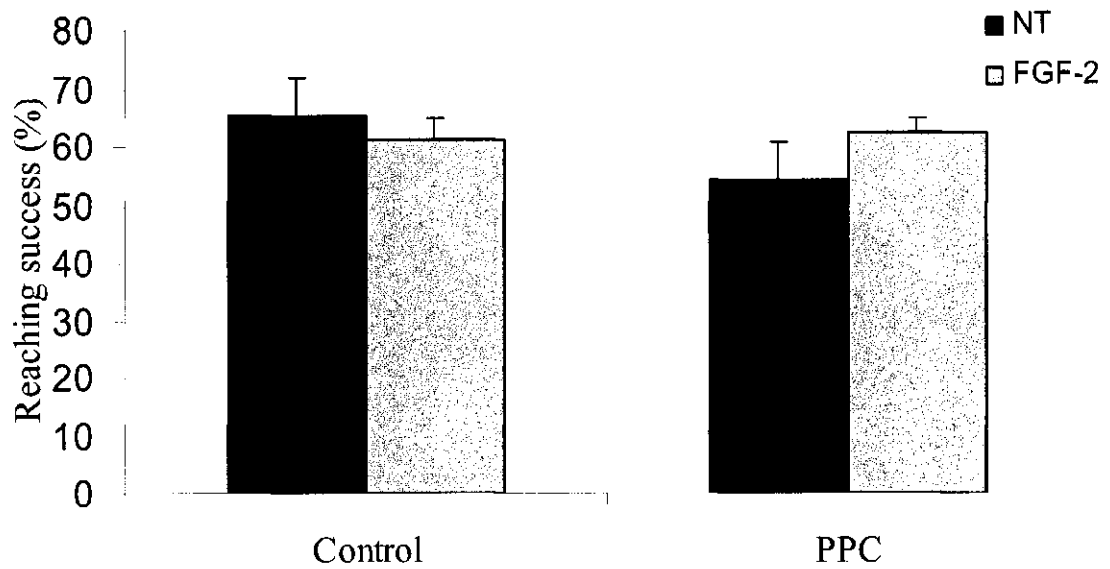

Figure 3-17 *Percentage of successful reaches for food pellets*

3.3.4.3. Open Field Test

Activity level was comparable among groups, with the only differences found being between sexes. Females, on average were more active than males (see Table 3-10). An ANOVA with sex, lesion, and treatment as variables showed a main effect of sex, $F(1,33) = 9.567$, $p = 0.004$, but no main effect of lesion, $F(1,33) = 0.663$, $p = 0.421$, nor treatment, $F(1,33) = 0.068$, $p = 0.796$. There were no interactions (p 's > 0.10).

Table 3-10 *Summary of mean activity level*

Group	Activity Level	
	Male	Female
NT Control	363.50	491.53
NT PPC	422.68	553.74
FGF Control	372.21	515.69
FGF Control	396.90	503.72

3.4. DISCUSSION

Two experiments examined the affect of exogenous FGF-2 on the enhancement of functional recovery, as well as the anatomical irregularities, following either bilateral medial frontal or bilateral posterior parietal cortical lesions at postnatal day 3 (P3). Table 3-11 summarizes the results of the anatomical and behavioral measures.

Table 3-11. Summary of results from Experiment 2.1 and 2.2.

(❖◆) significant decrease/increase relative to untreated Lesion counterpart; (❖◆) significant decrease/ increase relative to NT Control group; (⊞) no significant difference relative to controls; (NA) not applicable.

Abbreviations: M = medial cortex, L = lateral cortex, V = ventral cortex.

Note: A decrease/increase in medial, lateral, or ventral cortices was considered significant if two or more planes were significantly different relative to controls

RESULTS:											
<u>Group</u>	<u>Anatomical</u>								<u>Behavioral</u>		
	<u>Body Wt</u>	<u>Brain Wt</u>	<u>Cerebellum</u>	<u>Cortex SA</u>	<u>Lesion SA</u>	<u>Cortical planes</u>	<u>Thalamus</u>	<u>Brain Stem</u>	<u>Water task</u>	<u>Reaching</u>	<u>Open field</u>
NT MFC	⊞	❖	⊞	❖	⊞	❖ MLV	❖	❖	❖	❖	⊞
FGF MFC	❖	❖	◆	❖	⊞	❖ MLV	❖	❖	⊞◆	❖◆	⊞
FGF C	⊞	❖	⊞	⊞	NA	◆ L	❖	⊞	◆	⊞	⊞
NT PPC	⊞	❖	⊞	❖	NA	❖ M,L	⊞	⊞	❖	⊞	⊞
FGF PPC	❖	❖	⊞	❖	NA	❖ MLV	❖	⊞	❖◆	⊞	⊞

The general findings of the current experiment were: 1) Lesions of either the MFC or PPC produced deficits on a spatial task. MFC, but not PPC, lesion rats showed a deficit in

skilled reaching; 2) Anatomical irregularities following either lesion included a reduction in brain weight and cortical thickness. As well, there was a shrinkage of the anterior and posterior thalamus in MFC, but not PPC, lesion rats; 3) FGF-2 treatment improved performance on the spatial task in both lesion groups, and improved reaching performance of MFC lesion rats; 4) FGF-2 had a differential effect on anatomical irregularities.

3.4.1. Effects of postnatal day 3 MFC and PPC lesions on cognitive and motor tasks.

The cognitive and motor deficits that have been previously reported following MFC or PPC on postnatal day 3 (P3) were also found in the current experiment. Rats with either MFC or PPC lesions were impaired in the place task version of the Morris water task relative to unlesioned rats. The impairments, however, were not equal across lesion groups. First, based on daily latency scores, there were observable differences in the learning curve between MFC and PPC lesion rats suggesting that the impairment is less severe following MFC lesions than observed following PPC lesions. Second, MFC lesion rats typically started from the edge of the pool in the general direction of the platform. Their heading was inaccurate, however, as they had to search for the platform once in the vicinity. In contrast, the PPC lesion rats most often started from the pool edge in the wrong direction, but once they had corrected their heading, were able to locate the platform. These variations in searching for and locating the platform suggest that there are differences in the spatial navigation deficits. MFC lesion rats showed an impairment in remembering the relationship of cues and the platform, whereas the consistently

inaccurate heading of the PPC lesion rats suggests that their deficit is related to the accurate guidance of body through space.

MFC lesion rats, but not PPC lesion rats, were also impaired in the Whishaw tray reaching task. The MFC has a large number of neurons in Layer V that project to the spinal cord (Miller, 1987). Thus, the motor deficit in skilled reaching following MFC lesions is likely the result of a substantial loss in corticospinal connections that do not appear to reestablish connectivity following perinatal or adult cortical lesions.

3.4.2 Anatomical irregularities following P3 MFC and PPC lesions

A number of anatomical deficits were found following both MFC and PPC lesions. The most marked irregularities for both lesion groups were a thinning of the cortical mantle and a reduction in brain weight. The MFC lesion rats showed a substantial decrease in the lateral and ventral, as well as the posterior planes of the medial cortices, whereas the PPC lesion rats showed a substantial decrease in the medial and lateral, but not ventral, cortices on most cortical planes. The reduction in the posterior cortex (medial, lateral and ventral) following MFC lesions may be, in part, a consequence of the delayed development in the posterior cortex relative to the anterior cortex (Bayer & Altman, 1991). It has been previously reported that the reduction in cortical mantle is typically caudal to the lesion site, suggesting that migration of cells to the later developing posterior cortex is disrupted and cells are rerouted to the injured site. Thus, the reduction in the posterior cortical mantle following MFC lesions is likely a combination of retrograde cell death due to loss connectivity, as well as the partial loss of migrating cell populations. The thinning of the anterior cortical mantle lying rostral to PPC lesion site is

likely then a consequence of loss connectivity. Yet, there is also a ventral to lateral gradient, and a lateral to medial gradient, as well as the anterior to posterior gradient in cortical development. Therefore, the thinning of the medial and lateral, but not ventral cortex, following PPC lesions may be attributable, in part, to a difference in developmental timing of the disruption relative to the MFC lesion.

Brain weight was substantially decreased in adulthood following either the P3 MFC or P3 PPC lesions. A substantial loss in cortical matter, a thinning of the remaining cortical mantle, and a decrease in the overall cortical surface area were all likely contributing factors in producing lighter brain weights. The reduction in overall cortical SA, but not cerebellum SA, suggests that the decrease in brain weight was related to a loss of neocortical matter. Furthermore, that all these factors continue to show substantial losses into adulthood suggests limitations in brain plasticity at P3, a finding that is consistent with previous studies of MFC and PPC lesions. As well, a shrinkage of anterior and posterior thalamic cross-sectional areas following MFC lesions shows substantial retrograde damage occurs in cortico-subcortical connections that do not appear to reestablish or reorganize after injury.

3.4.3 Impact of post-operative FGF-2 on behavioral outcome and anatomical results following P3 MFC and PPC lesions

Subcutaneous injections of FGF-2 following P3 lesions of the MFC or PPC produced an improvement in performance on the place task version of the Morris water maze for both lesion groups. As well, the treated MFC lesion rats had a marked improvement in successful reaches based on the Whishaw tray reaching task.

The MFC rats showed an improvement with FGF-2 treatment, as FGF-2 treated MFC lesion rats showed no apparent deficit in performance on the Morris water task relative to controls, and as well showed a modest improvement in performance over the untreated MFC lesion rats. There was a similar effect in FGF-2 PPC rats, as they showed a substantial improvement over the untreated PPC lesion rats. They did remain impaired at the task relative to controls, however. Yet, one must be cautious in drawing conclusions based on comparisons of the degree of behavioral improvement shown by the MFC and PPC rats, as P3 PPC lesion rats are typically much worse at the task relative to P3 MFC lesion rats. Furthermore, as pointed out earlier, the deficits that result from lesions to the MFC or PPC are not the same.

A novel finding was the improvement in reaching success in rats treated with FGF-2. Typically, it has been found that corticospinal connections lack the display of plasticity shown in corticocortical connections. Thus, an improvement in motor skills following MFC lesions normally is limited, if present at all. In the current experiment, however, there was a marked improvement in skilled reaching relative to the untreated MFC lesion rats, although they did not acquire the level of accuracy as the controls at the task. Nonetheless, the improvement shows that FGF-2 treatment is a viable treatment strategy in enhancing both cognitive and motor deficits.

It was hypothesized that the application of exogenous FGF-2 following P3 lesions might stimulate the same plastic changes that occur following similar lesions during the second week of development when there is a greater availability of endogenous FGF-2. This protein has been shown to support neuronal cell survival and stimulate mitosis both during development and in response to injury. Therefore, we had expected to find a

reduction in a number of anatomical irregularities that result from lesions of the MFC and PPC. The results, however, showed only a limited effect on these irregularities that was mainly restricted to an increase in posterior thalamic cross-sectional measures in the MFC group and a slight decrease in the number of cortical planes that showed a reduced mantle in the MFC, but not PPC, lesion rats.

The absence of shrinkage in the posterior thalamic cross-sectional area in treated MFC rats supports the improvement in skilled reaching if we assume that it is due to the rescue or reorganization of corticospinal connections. There remains the question of anatomical support for the cognitive task in both the MFC and PPC lesion groups, however. A possible explanation may be that there were changes in the intrinsic connections that were not evident in the measures used in the current experiment. For example, although there was no apparent gain in thickness of the cortical mantle or brain weight, surviving neurons may have altered their connections in the presence of exogenous FGF-2, possibly generating a greater number of synapses. Although this often leads to an increase in cortical matter that is exemplified by an increased brain weight, the changes may not have been as profound.

A very interesting finding that has yet not been dealt with is the increase in size of the cerebellum in only those rats that had received both a lesion and FGF-2 treatment. Whether or not this may have played a role in the improved functional recovery is difficult to say and speculative at best, but the notion does deserve future consideration.

4. *Experiment 3: Prenatal FGF-2 and recovery following P3 MFC and PPC cortical lesions*

ABSTRACT

The current experiments examined the potential of prenatal exogenous basic fibroblast growth factor (FGF-2) in the enhancement of behavioral functional recovery after either postnatal day (P) 3 bilateral medial prefrontal (MF) or bilateral posterior parietal (PP) cortical lesions. It was hypothesized that prenatal delivery of exogenous FGF-2 would enhance the production of cortical neurons which in turn would prove beneficial in enhancing recovery from postnatal injury.

Dams were either left to carry and deliver pups without intervention or were administered FGF-2 subcutaneously on embryonic day (E) 15.5. On P3, pups received one of three lesions: 1) sham lesion; 2) MFC lesion; 3) PPC lesion. The results of a cognitive task (water maze) and a motor task (skilled reaching) showed a substantial improvement in rats pretreated with FGF-2 following P3 MFC lesions relative to controls and to a lesser extent following P3 PPC lesions. The extent of behavioral recovery was correlated with anatomical measures that may be supported, in part, by an increase in brain weight and cortical thickness in the FGF-2 treated rats over untreated lesion rats.

4.1 INTRODUCTION

Deficits following postnatal day 3 (P3) lesions of the medial frontal cortex (MFC) include cognitive impairments, such as spatial memory, measurable in the Morris water task, as well as motor deficits found in tasks involving forelimb use, such as in skilled reaching. Posterior parietal cortical (PPC) lesions, on the other hand, produce enduring deficits in spatial navigation but little to no impairment in motor skills. Although injury to either location produces impairments in the water maze, these two brain regions respond very differently to injury and intervention strategies. Functional outcome following PPC injury is extremely poor in comparison to injury of the MFC. Thus, whereas there is some recovery of function following P3 MFC lesions, P3 PPC lesions show very little recovery of function. Furthermore, a number of intervention strategies, including application of exogenous postnatal basic fibroblast growth factor (FGF-2), have been shown to be useful in diminishing the behavioral deficits of MFC lesions, whereas few treatment strategies following PPC lesions have been investigated.

One area that has been well studied in animals with lesions is prenatal factors. Prenatally, developmental progression in the central nervous system (CNS) coincides with the appearance of a number of neurotrophic factors, including FGF-2 (Mocchetti & Wrathall, 1995). Previous research has shown that FGF-2 is first available in the developing cortex between embryonic day 13 (E13) and E14 (Gomez-Pinilla, Lee & Cotman, 1994). FGF-2 is of special interest because of its diversity and influence during different stages of development and its influence on various cell phenotypes (Gomez-Pinilla *et al.*, 1994; Koketsu, Berlove, Moskowitz, Kowall, Caday & Finklestein, 1994). The role that FGF-2 plays during cortical development is still under investigation but

there is evidence to suggest that it has an influence on cell proliferation, and differentiation of neurons (Caday, Klagsbrun, Fanning, Mirzabegian & Finklestein, 1990; Engele & Bohn, 1992; Tao, Black & Dicicco-Bloom, 1997). Support of the role of FGF-2 in neuronal proliferation is provided by a study that reported an increase in cortical surface area and neuronal numbers following exogenous prenatal FGF-2 (Vaccarino, 1999). An interesting question is whether such an increase in neuronal numbers would support or enhance functional recovery after brain injury. The purpose of Experiment 3 was to examine the behavioral benefits and anatomical correlates in MFC and PPC lesion animals that had received prenatal exposure to exogenous FGF-2. Because the suspected effect of FGF-2 on neuronal proliferation had not been replicated, an anatomical study in which a mitotic marker (Bromodeoxyuridine) was used to identify new cells that were generated after the FGF-2 injections was added as Appendix 2.

4.2 MATERIALS AND METHODS

There were two experiments. Experiment 3.1 compared the gross anatomical and behavioral effects of exogenous prenatal FGF-2 treatment to animals with P3 MFC lesions and no treatment. Experiment 3.2 used the same anatomical and behavioral measures to compare the effects of exogenous prenatal FGF-2 to animals with P3 PPC animals. Appendix 2 compared the effect of exogenous prenatal treatment of FGF-2 on early postnatal cortical neuronal density to controls.

4.2.1 Subjects

Sixty-eight Charles River Long-Evans rats were used. The pups of 5 litters (N = 44) were used for the No Treatment (NT) groups. The pregnancies were normal and went full term without intervention. The pups of two more litters (N = 24) received prenatal FGF-2 via subcutaneous FGF-2 injections of the dam and used for the PreFGF treatment groups. On postnatal day 3 (P3), pups were randomly assigned to receive one of three lesions. Six groups were created: [1] NT sham (N = 13, 5M ; 8F), [2] NT MFC (N= 15, 6M ; 6F), [3] NT PPC (N = 16, 7M ; 9F), [4] Pre-bFGF sham (N = 8, 3M ; 5F), [5] Pre-bFGF MFC (N = 7, 4M ; 3F), [6] Pre-bFGF PPC (N = 9, 5M ; 4F). Each litter contained pups from all 3 lesion groups. The six groups were divided into two experiments: Experiment 3.1 included 4 groups; [1] NT sham, [2] NT MFC, [3] Pre-bFGF sham, [4] Pre-bFGF MFC. Experiment 3.2 also included 4 groups; [1] NT sham, [2] NT PPC, [3] Pre-bFGF sham, [4] Pre-bFGF PPC.

Pups were housed with dams in clear plexi-glass hanging tubs with a 12 hr light/dark schedule until they were weaned. Once weaned, the young rats were housed in litter-mate, same-sex groups of 2 to 3. Subjects had access to ad-lib food and water throughout the behavioral testing period, except for a period of food deprivation during the Whishaw reaching task. Behaviour testing began when pups were about 60 days old. Following behavior testing, animals were sacrificed and brains were prepared for anatomical analysis.

4.2.2. Prenatal FGF-2

Prenatal FGF-2 was administered through subcutaneous injections of the dam. Dams were housed with same sex littermates and monitored on a daily basis with an EC40 Estrus Cycle Monitor to determine their estrous cycle. A chart included in the Estrus Cycle Monitor kit was used to translate the recorded readings into a percentage that represents the likelihood of impregnation on that day. When the monitor reading translated into an 85 – 90 % likelihood of impregnation, the female was removed from her cage and coupled with a male. Estrous cycle readings were taken in the afternoon, therefore the day that the male was introduced was considered embryonic day 0.5 (E 0.5).

The dams received subcutaneous injections of FGF-2 on embryonic day (E)15.5. Injections were administered to two locations: 1) in the nape of the neck and, 2) the upper thigh. A FGF-2 concentration of 10 μ g FGF-2 per 1ml BSA was used. A dose of 0.1 ml/100 gram body weight was administered for each injection site (about 0.3mls). Therefore, each dam received a total of 0.6mls or 6 μ g of FGF-2.

4.2.3. Surgical Procedures

On postnatal-day 3 (P3), the pups were anesthetized via hypothermia in a Thermoatrom cooling apparatus. Surgery began when rectal temperatures reached approximately 18°-20°C and the pups were immobilized. The overlying skull above the intended cortical lesion was removed with iris scissors. The target cortex was removed with gentle aspiration and the incision was sutured with sterile silk thread. Pups were slowly warmed to normal body temperature and returned to their dams. Aside from the actual lesion site, the above procedures were repeated for both the MFC and PPC lesions. For the sham controls, the skin overlying the skull was incised and then sutured as with the lesion groups.

Posterior parietal cortical (PPC) lesions

To remove the PPC (region roughly analogous to Kreig's area 7), the skull was removed slightly anterior to where the PPC is located in adulthood (Kolb & Walkey, 1987). Adjusting for continued posterior brain development, an area of the brain covered by the middle third of the skull between bregma and lambda was determined to be the appropriate location of the PPC (Kolb & Cioe, 1998).

Medial frontal cortical (MFC) lesions

Lesions were performed by removing the frontal bone anterior from bregma. Zilles (1985) areas Cg1, Cg3, and much of Fr2 were removed.

4.2.4. Histology

At the conclusion of behavioral testing, animals were given an overdose of sodium pentobarbital and intracardially perfused with 0.9% saline solution followed by 4% paraformaldehyde (p.f.a.). The brains were removed and stored in 30% sucrose in 4% p.f.a. post-fixative solution. About three weeks after perfusion, the brains were removed from the solution, frozen, and cut at 40 μ m on the cryostat. Every 10th section was saved and mounted on coated-slides. Sections were left to air dry and stained with Cresyl violet.

4.2.5 Anatomical Measurements

Measurements of body weight, brain weight, cortical thickness, cerebellum, cortical and lesion surface area (SA), anterior and posterior thalamic cross-sectional areas were taken for anatomical comparisons between groups.

Brain Weight

Once harvested, brains were left in post-fixative for about one week and then re-weighed. Each brain was placed into a mold trimmed evenly. After being trimmed, the brains were weighed and returned to the post-fixative solution until sliced.

Lesion surface area

Measurements of lesion SA were used to determine the extent of visible cortical lesion in MFC animals. PPC lesions were excluded from this analysis as these lesions are often invisible on the surface due to the collapse of surrounding cortex into the lesion cavity (see Figure 4-1a). Photographs of the brains prior to sectioning were transferred to NIH

Image and measurements were taken of the dorsal cortical and cerebellum surface area (SA) (see Figure 4-1*b*). Lesion SA was also taken for the MFC lesion groups and the percentage of cortex lost as a result of the lesion was calculated.

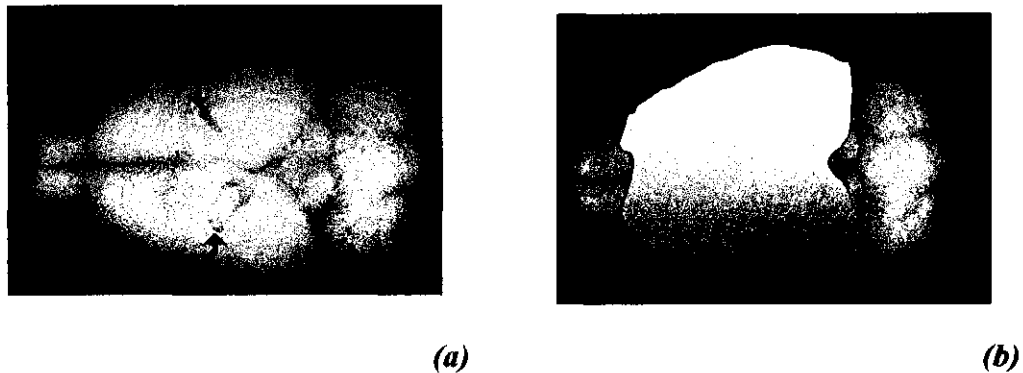

Figure 4-1. *Dorsal view of lesion site (a) posterior parietal lesion (b) medial frontal lesion*

Cortical thickness

In the present study, cortical thickness was obtained from five specific cortical planes. Plane 1 was identified by the first anterior section containing the striatum, Plane 2 by the appearance of the anterior commissure, Plane 3 by the bilateral appearance of the anterior hippocampus, Plane 4 by the visibility of the posterior commissure, and Plane 5 was identified by the last section that included the posterior hippocampus. Bilateral measurements were taken at three different locations for each cortical plane described (see Figure 4-2). The first location represented the midline (medial) cortex, the second location represented the lateral cortex, while the third location represented the ventral-lateral (ventral) cortex. As the lesions were bilateral, an average of both hemispheres was

used for analysis. In the case of absent cortex, such as with anterior planes following MFC lesions, these planes were omitted from analysis.

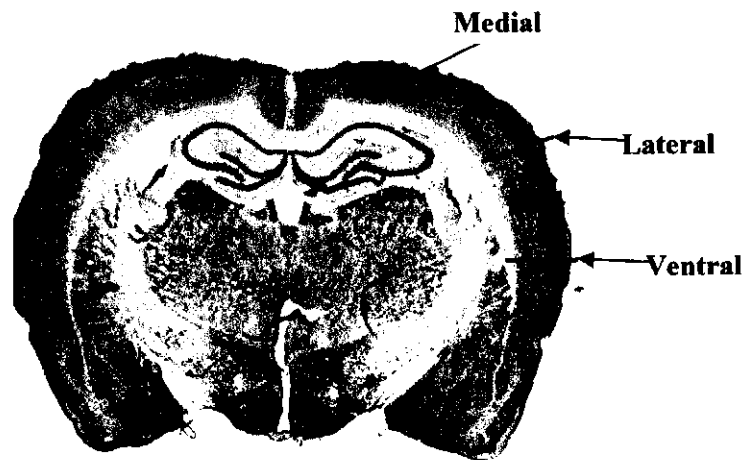

Figure 4-2. *An example of a coronal sections through normal brain showing the three locations where measurements were taken on each of five planes to calculate cortical thickness.*

Thalamic Area

The area of the diencephalon was measured at the level of the dorsal medial nucleus (MD) of the thalamus (Figure 4-3a) and the lateral geniculate nucleus (Figure 4-3b).

Photographs of the respective sections were taken at a constant magnification and transferred to NIH Image. The thalamic area was measured at a constant enlargement and the area calculated in mm.

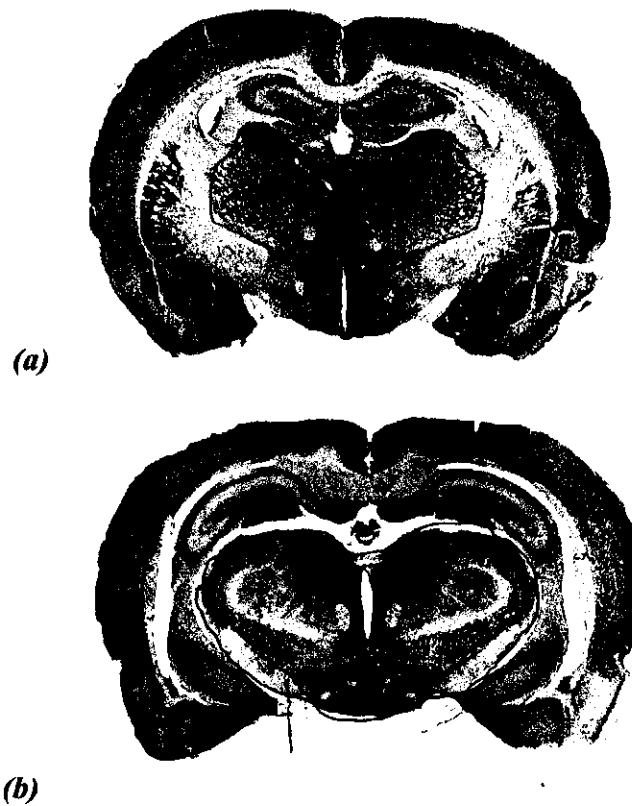

Figure 4-3. *Coronal sections of a normal control rat showing the thalamic area that was measured, as identified by the outlined segments of each figure.*

4.2.6. Behavioural Testing

Animals were tested using the standard *place task* version of the Morris Water Task (see Figure 4-4). The pool measured 1.5 meters across and 45 cm high. A number of distal visual cues were located around the room and no attempt was made to screen them from view. The pool water was made opaque with ~1200ml of milk powder with a temperature of 21-25 degrees celcius. A square platform measuring 30 cm high was placed in the pool about 2cm beneath the water surface.

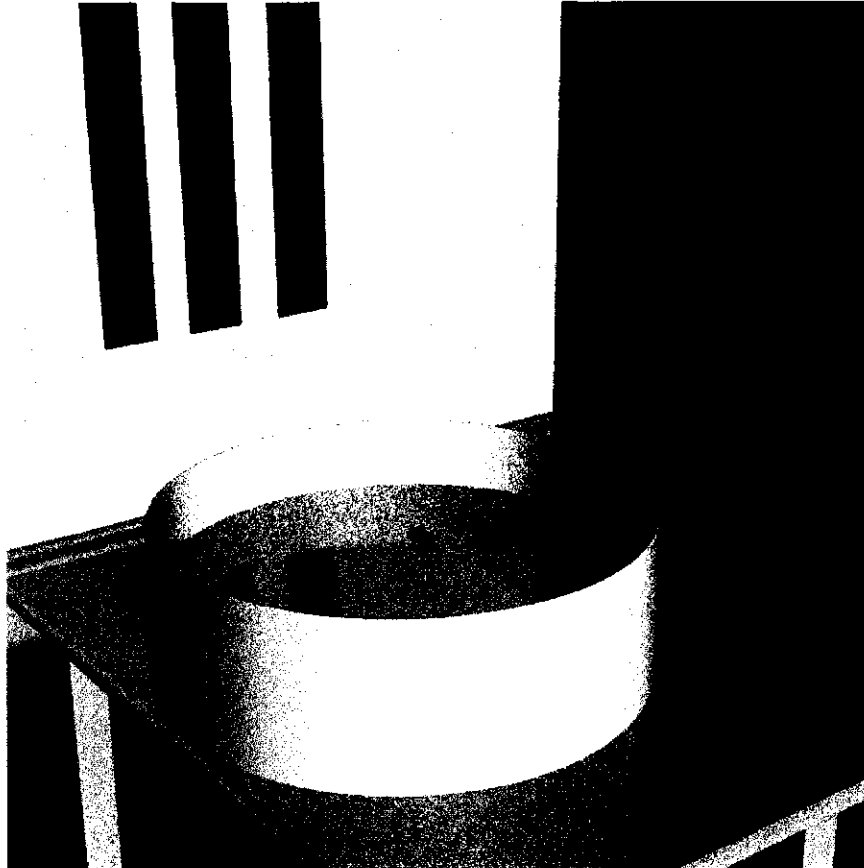

Figure 4-4. *A cartoon of the Morris Water Maze pool setup, and the type of cues present in the room.*

To begin the test, the experimenter placed the animal into the water with its nose facing the pool wall. The rat was released and the timer started. Each rat was allowed to search for the platform for a maximum of 90 sec. The time required to find the platform was recorded, as was the swim speed. When the animal found the platform it was allowed to remain there for another 10 seconds before being returned to the holding cage. If the rat did not find the platform within 90 sec., the rat was guided to the location and also allowed to stay on the platform for 10 sec. before being removed from the pool. Rats received four trials per day, starting from a different location each time.. The testing ran for seven consecutive days, with each day representing one trial block. On the eighth day

a single probe trial was conducted. During the probe trial the platform was removed and once placed in the pool, the animal was allowed to search for 60 sec. before being removed.

Whishaw Tray Reaching Task

Rats were food deprived and maintained at 85% of their normal weight, adjusting for continued growth. Food deprivation consisted of removing ad lib food bins from the home cages and limiting food consumption to about 15 - 20 grams/day per rat.

Testing cages measured 30.5cm high by 20.5 cm wide by 28.0 cm in length. The sides and back of the cage were made of clear plexi-glass, thin metal bars formed the front of the cage, and the bottom was made of wire mesh (see Figure 4-5). Food trays ran the length of the cage front with about 5cm between the tray and the cage. The spacing between the tray and cage allowed the rats to reach and retrieve food pellets that were placed on the tray, but prevented the rat from simply 'dragging' the pellets into the cage.

For the first three days, rats were placed in the reaching cages in groups for one hour. For the following seven consecutive days, rats were individually caged and allowed to retrieve and consume pellets for half an hour/day. By the 10th day the animals had learned the task and controls were proficient at food retrieval. On the 11th day each animal was video taped for five minutes. The number of attempts and successes in reaching for, and obtaining, food pellets was later scored. A reaching attempt was scored each time the fore-paw was extended through the bars and an attempt was made to grasp the pellets. When the attempt resulted in the successful retrieval and consumption of a

food pellet, a success was recorded. The percentage of successes over attempts was calculated.

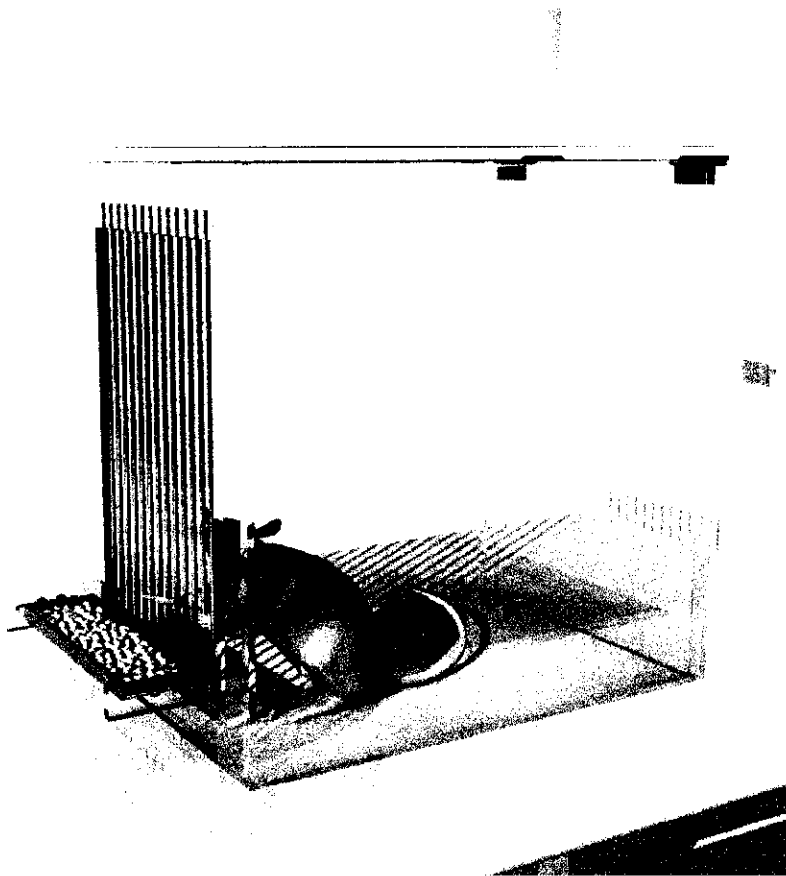

Figure 4-5. *Cartoon of the reaching compartment used in the Whishaw Tray reaching task.*

Open Field Testing

Individual activity in a novel environment was measured for a 10 minute period using a Digiscan apparatus. The digiscan is a clear plexi-glass box that measures 30.5cm high by 41 cm wide by 41cm long that monitors and records movement. Animals were

transported to a behaviour testing room where they were individually placed in the digiscan box for 10 minutes. At the end of the 10 minutes, the animal was removed and returned to the holding cage.

4.2.7. Statistical Methods

Analyses of variance were used for all statistical measures except where homogeneity of variance was violated. In these cases a Mann Whitney-U or Students' *t*-test was used. *Post hoc* evaluations were conducted with Fisher's LSD ($P < 0.05$) unless the results were unexpected, and thus truly post hoc, in which case the more conservative Tukey's HSD ($P < 0.05$) was performed.

4.3. RESULTS

Experiment 3.1 Medial Prefrontal Cortical Lesions

4.3.1. ANATOMICAL RESULTS

4.3.1.1. Body Weight

Body weight of both the male and female rats with lesions of the MFC was comparable to that of the controls whether or not the lesion animals had received treatment of PreFGF. An ANOVA of male body weight with lesion and treatment as variables showed no main effect of lesion, $F(1,14) = 0.751, p = 0.401$, nor treatment, $F(1,14) = 0.007, p = 0.933$, nor interaction, $F(1,14) = 1.203, p = 0.291$. An ANOVA of female body weight also showed no main effect of lesion, $F(1,18) = 1.703, p = 0.208$, nor treatment, $F(1,18) = 0.161, p =$

0.693, or the interaction, $F(1,18) = 0.130$, $p = 0.722$. There were no differences among groups of either sex (p 's > 0.100).

Table 4-1. *Summary of mean body weight for each sex in grams*

Group	Body Weight (grams)	
	Male	Female
NT Control	436 ± 34	287 ± 11
NT MFC	382 ± 21	276 ± 6
PreFGF C	408 ± 6	286 ± 8
PreFGF MFC	415 ± 23	268 ± 2

4.3.1.2. Brain Weight

Sexes were analyzed separately. Male and female rats with P3 MFC lesions showed a reduction in brain weight relative to sham controls, whereas both male and female FGF-2 treated rats showed an increase in brain weight. The brain weight of treated lesion males was still lighter than controls but heavier than the untreated lesion male rats. In contrast, female MFC lesion rats treated with FGF-2 had comparable brain weights to both the controls and untreated MFC rats (see Table 4-2).

ANOVA's of each sex, with lesion and treatment as variables, showed a main effect of lesion in males, $F(1,14) = 35.42$, $p = 0.000$, and the interaction, $F(1,14) = 11.875$, $p = 0.004$, but no main effect of treatment, $F(1,14) = 0.213$, $p = 0.652$. For females, there was a main effect of lesion, $F(1,17) = 6.227$, $p = 0.023$, and a marginal effect of treatment, $F(1,17) = 3.345$, $p = 0.085$, but no interaction, $F(1,17) = 0.471$, $p =$

0.502. Fisher's LSD tests showed that males in both the NT MFC and FGF-2 MFC groups had significantly lower brain weights relative to NT Controls ($p = 0.000$ & $p = 0.001$).

Table 4-2. Summary of mean brain weight in grams

Brain Weight (grams)		
Group	Male	Female
NT Control	1.75 ± 0.02	1.54 ± 0.04
NT MFC	$1.49 \pm 0.01^{**}$	$1.40 \pm 0.03^*$
PreFGF C	1.67 ± 0.02	1.59 ± 0.02
PreFGF MFC	$1.60 \pm 0.06^{**\dagger}$	1.51 ± 0.10

\dagger significantly different from NT MFC at $p \leq .05$

* significantly different from NT Controls at $p \leq .05$

** significantly different from NT Controls at $p \leq .001$

FGF-2 treated lesion males, however, had significantly heavier brains than their NT MFC counterparts ($p = 0.011$). Females, on the other hand, showed a significant reduction in the brain weights of NT MFC rats ($p = 0.011$), but not in the FGF-2 MFC rats ($p = 0.694$) relative to controls.

4.3.1.3. Cerebellum SA

Lesions of the MFC on P3 did not affect cerebellum size in adulthood. Treatment with PreFGF resulted in a larger cerebellum in lesion rats relative to both the untreated controls and the untreated lesion animals (see Table 4-3). There was, however, no effect of PreFGF on cerebellum size in rats without lesions.

Table 4-3. Summary of the mean dorsal surface area of the cerebellum in pixels

Group	NT	PreFGF
Control	352.04 ± 6.57	359.59 ± 4.31
MFC	349.80 ± 4.68	368.07 ± 4.39*†

* significantly different from Controls at $p \leq 0.05$

† significantly different from NT MFC at $p \leq 0.05$

An ANOVA with lesion and treatment as variables showed a significant main effect of treatment, $F(1,21) = 6.774$, $p = 0.017$, but not lesion, $F(1,21) = 0.395$, $p = 0.536$, nor the interaction, $F(1,21) = 1.167$, $p = 0.292$. A Fisher's LSD showed that PreFGF MFC rats had a significantly larger cerebrum surface area relative to both untreated controls and untreated lesion rats ($p = 0.042$ & $p = 0.017$, respectively). There were no other significant differences among groups (p 's > 0.100).

4.3.1.4. Cortical SA

MFC lesions produced a decrease in dorsal cortical surface area (SA) in the untreated rats relative to controls. In contrast, rats with MFC lesions and PreFGF treatment did not show a decrease in cortical surface area relative to controls. There was no apparent affect of PreFGF treatment on controls.

An ANOVA with lesion and treatment as variables showed a trend towards a main effect of lesion, $F(1,22) = 3.577$, $p = 0.072$, but no main effect of treatment, $F(1,22) = 1.778$, $p = 0.196$, nor interaction, $F(1,22) = 2.666$, $p = 0.117$. A Fisher's LSD showed

that the NT MFC rats had a significantly smaller dorsal area relative to both the NT controls and the PreFGF MFC rats ($p = 0.042$ & $p = 0.017$, respectively).

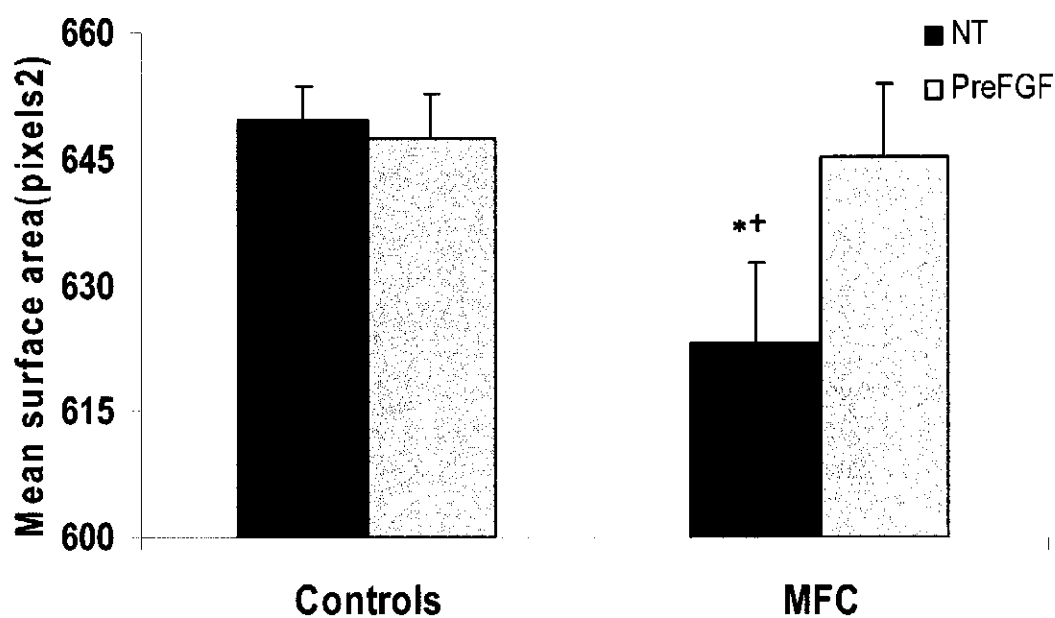

* significantly different from NT Controls
† significantly different from PreFGF MFC rats

Figure 4-6. Graph of the mean surface area of the dorsal cortex in pixels²

4.3.1.5. Lesion SA

Surface area (SA) of the lesion shown from the dorsal cortex was slightly less in the untreated relative to the FGF-2 treated MFC lesion animals (see Figure 4-7). A One-way ANOVA of lesion SA with treatment as a variable, however, showed that the difference was not significant, $F(10) = 2.233$, $p = 0.166$.

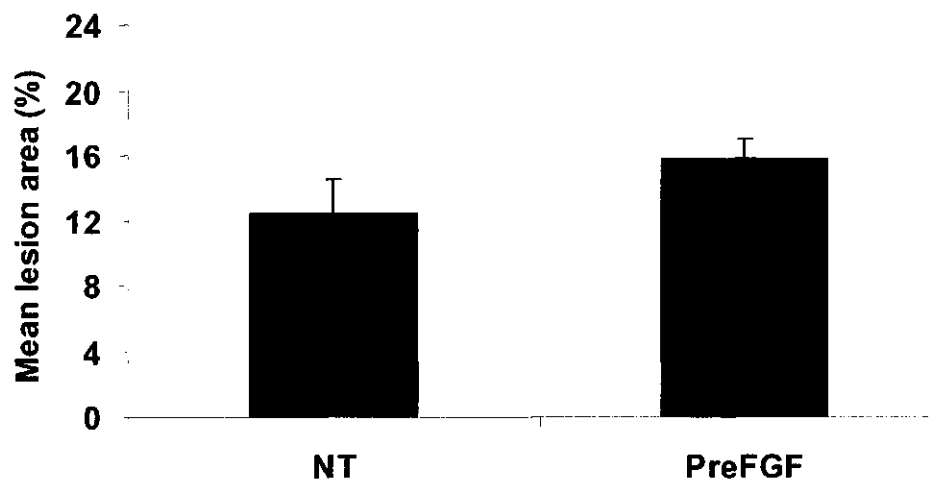

Figure 4-7 Mean lesion size as a percentage of dorsal cortex area

4.3.1.6. Cortical Thickness

The anterior planes of the medial, lateral, and ventral cortices in untreated MFC lesion rats showed a reduction in cortical thickness relative to controls (see Figures 4-8a - c). PreFGF-2 treatment moderated the reduction in cortical thickness in lesion rats, as treated lesion rats only showed a decrease in the medial cortex, with the exception of Plane 3 in the lateral cortex. PreFGF-2 showed little effect on cortical thickness of controls, however.

A Repeated-measures ANOVA of the **medial cortex** (Figure 4-8a) with lesion and treatment as variables showed a main effect of lesion, $F(1,14) = 40.24, p = 0.000$, but not treatment, $F(1,14) = 0.382, p = 0.547$, nor the interaction, $F(1,14) = 0.662, p = 0.429$. A Fisher's LSD test showed a reduction in the medial cortical mantle on Planes 1 and 3, but not 4, for both the NT MFC ($p = 0.000, p = 0.170, \& p = 0.033$, respectively) and PreFGF MFC ($p = 0.000, p = 0.106, \& p = 0.47$, respectively) rats. There were no significant differences between the treated and untreated controls (p 's > 0.100).

A Repeated-measures ANOVA of the **lateral cortex** (Figure 4-8b) with lesion and treatment as variables also showed a main effect of lesion, $F(1,14) = 7.86, p = 0.014$, but not treatment, $F(1,14) = 0.903, p = 0.358$, nor the interaction, $F(1,14) = 0.226, p = 0.642$. A Fisher's LSD test showed that untreated MFC rats had a significantly thinner cortex on Planes 1 -3, but not on Planes 4-5, ($p = 0.013, p = 0.027, \& p = 0.022, p = 0.914, p = 0.195$, respectively). In contrast, PreFGF MFC rats showed on a marginal reduction of cortex on Plane 3 ($p = 0.053$). No other significant differences were found among the groups ($p's > 0.100$).

A Repeated-measures ANOVA of **ventral cortex** (Figure 4-8c) with lesion and treatment as variables showed a main effect of lesion, $F(1,14) = 7.12, p = 0.015$, but not treatment, $F(1,14) = 0.012, p = 0.915$, nor the interaction, $F(1,14) = 0.175, p = 0.177$. A Fisher's LSD test showed that untreated MFC rats had a significantly thinner cortex on Planes 1 -3, but not on Planes 4-5, ($p = 0.024, p = 0.023, \& p = 0.021, p = 0.449, p = 0.117$, respectively). There was no significant decrease/increase in PreFGF MFC cortical thickness relative to controls ($p's > 0.100$), but the Pre FGF controls did show a significant increase in ventral cortical thickness on Plane 3 alone ($p = 0.020$) No other significant differences were found among the groups ($p's > 0.100$).

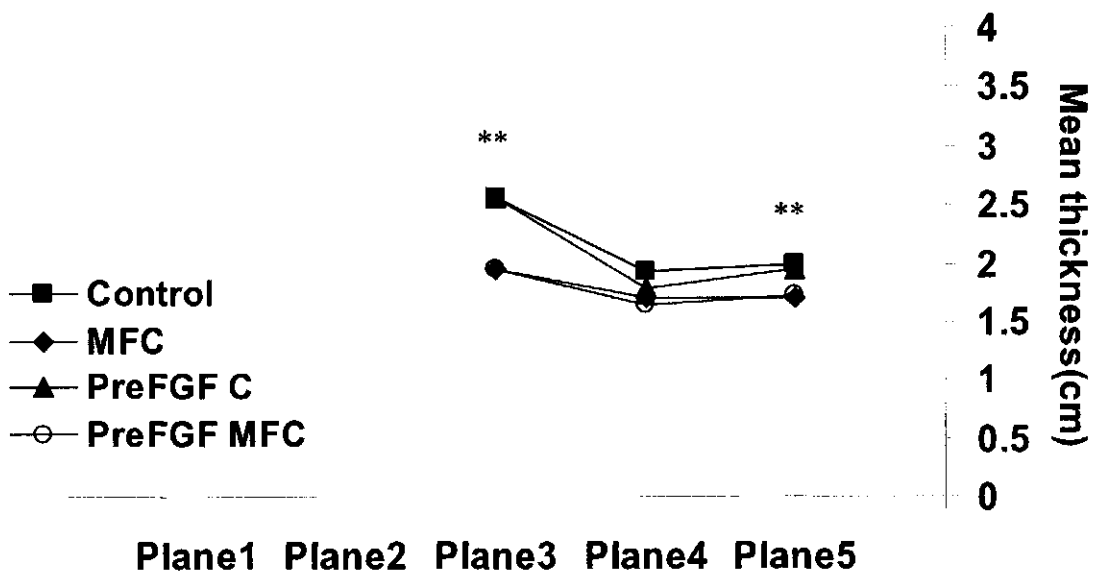

* significant difference between NT MFC and Controls
 * significant difference between PreFGF MFC and Controls
Figure 4-8a Medial Cortex

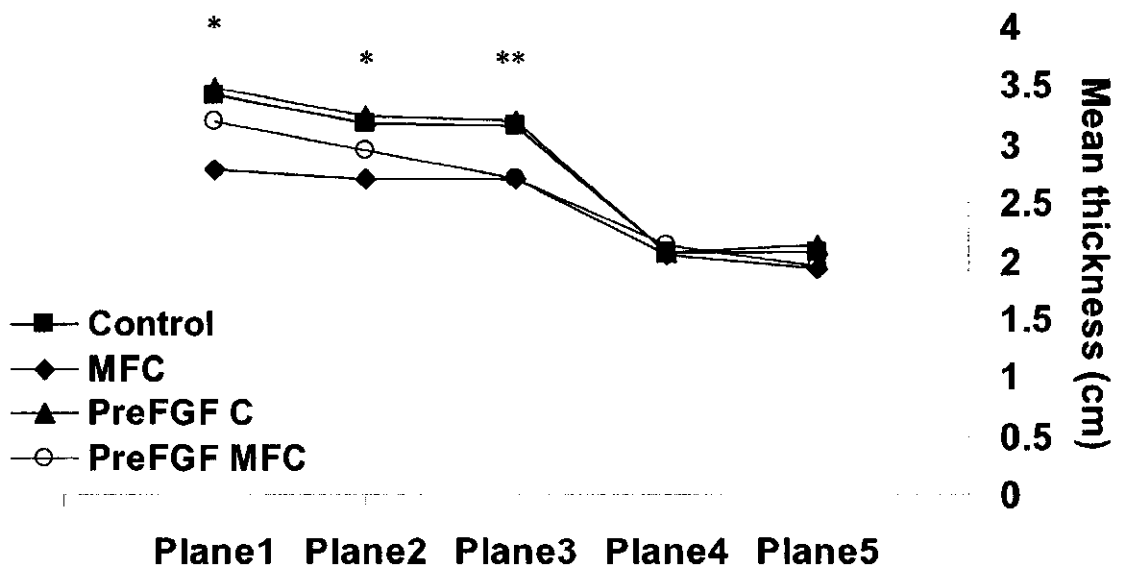

* significant difference between NT MFC and Controls
 * significant difference between PreFGF MFC and Controls

Figure 4-8b Lateral Cortex

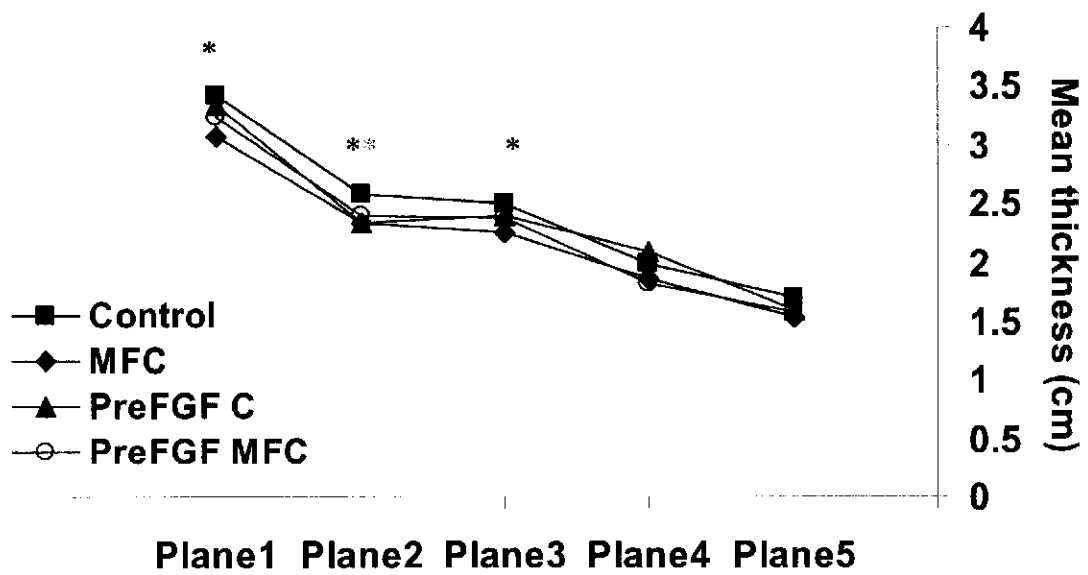

* significant difference between NT MFC and Controls

* significant difference between PreFGF Controls and NT Controls

Figure 4-8c *Ventral Cortex*

Figure 4-8 *Graphs depicting mean cortical thickness on five different planes for three different cortical areas (a) medial cortex, (b) lateral cortex, (c) ventral cortex.*

4.3.1.7. Anterior and Posterior Thalamic Cross-sectional Areas

The anterior thalamic cross-sectional area was shrunken in rats with early MFC lesions, whether or not they had received FGF-2 treatment, whereas, only the untreated MFC rats showed significant shrinkage in the posterior thalamus (see Table 4-4). FGF-2 treatment did moderate the anterior thalamic shrinkage in lesion rats, although it did not eliminate it.

Table 4-4. Summary of mean anterior and posterior thalamic area

Mean Thalamic Cross-sectional Measures (mm ²)		
Group	Anterior	Posterior
NT Controls	18.37 ± 0.64	30.11 ± 1.05
PreFGF Controls	17.20 ± 1.11	31.94 ± 0.99
NT MFC	14.39 ± 0.36**	27.48 ± 0.77*
PreFGF MFC	15.46 ± 0.20*†	28.46 ± 0.75

* significantly different from NT Controls at $p \leq 0.05$

** significantly different from NT Controls at $p \leq 0.001$

† significantly different from NT MFC group at $p \leq 0.05$

Measurements of the anterior thalamic cross-sectional area were analyzed with a Students' *t*-tests. The results showed a significant reduction in thalamic area in both the NT MFC and PreFGF MFC rats relative to controls [$t(9) = 5.67, p = 0.000$ & $t(9) = 4.334, p = 0.008$, respectively]. Although, significant shrinkage was still apparent relative to controls, the thalamic area was significantly larger in the PreFGF MFC group compared to NT MFC group, $t(10) = 2.617, p = 0.026$.

The results of an ANOVA of posterior thalamic cross-sectional area with lesion and treatment as variables showed a main effect of lesion $F(1,20) = 10.185, p = .005$, but no main effect of treatment, $F(1,20) = 2.138, p = 0.159$, nor the interaction, $F(1,20) = 0.198, p = 0.661$. A Fisher's LSD test showed only a marginally significant reduction in posterior thalamic area relative to the controls ($p = .07$) and no other differences among groups (p 's > 0.10).

4.3.2. BEHAVIORAL RESULTS

4.3.2.1. Morris Water Task

Rats with P3 MFC lesions were impaired in the water task (see Figure 4-9). Although the NT MFC animals did learn the task, the learning curve was not as steep as that found in 'normal' animals and they never became quite as good as the controls (see Figure 4-10). In contrast, MFC lesion rats treated with FGF-2 prenatally showed no impairment at all in the time it took to find the platform over the seven trial blocks (see Figure 4-9) and acquired the task at a rate that was as good, if not better, than the controls (see Figure 4-10).

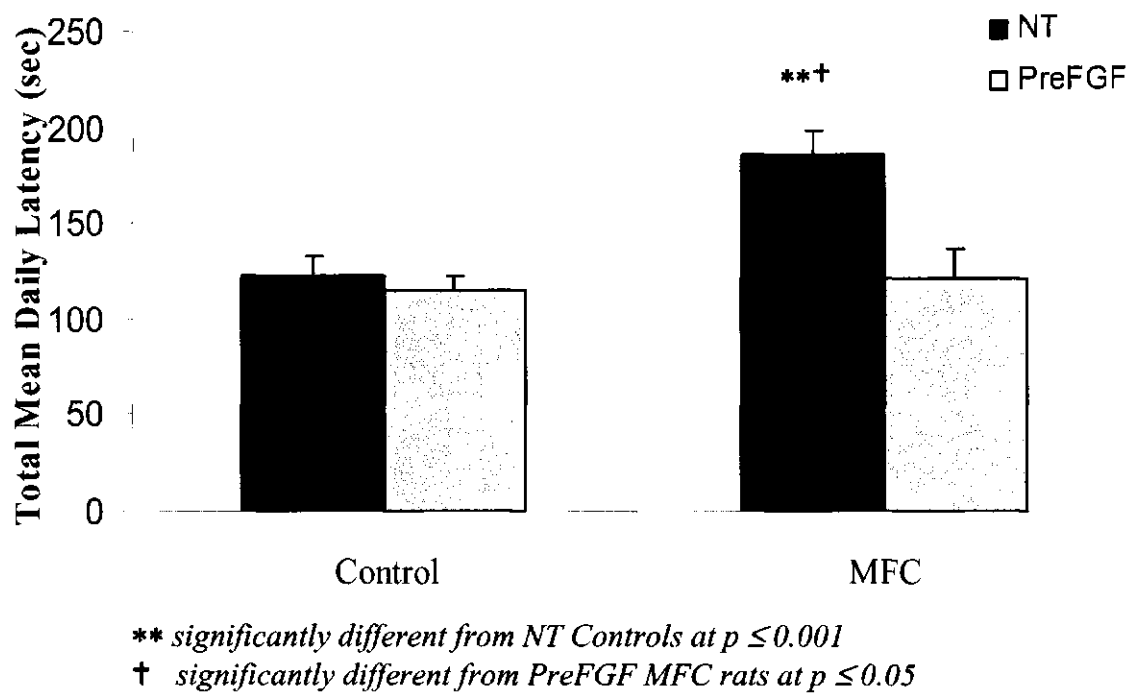
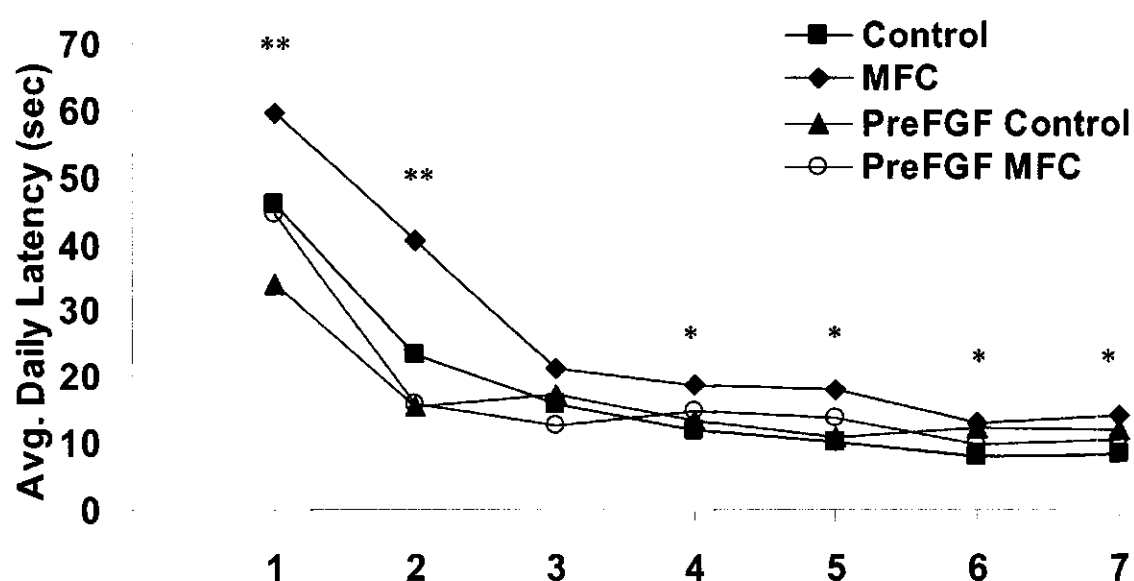

Figure 4-9. Total latency over 7 trial blocks

An ANOVA of sum latencies with lesion and treatment as variables showed a main effect of lesion, $F(1,38) = 6.28, p = 0.017$, and treatment, $F(1,38) = 6.98, p = 0.012$, as well as the interaction $F(1,38) = 4.18, p = 0.048$. A Fisher's LSD revealed a significant deficit in latency for the NT MFC rats relative to controls ($p = 0.000$), whereas the PreFGF MFC group showed no impairment relative to controls ($p = 0.928$) and performed significantly better than the NT MFC rats ($p = 0.003$).



* significant difference between NT MFC and NT Controls
 * significant difference between NT MFC and FGF MFC rats

Figure 4-10 Graph of the average latency per day (trial block)

A Fisher's LSD post hoc of Repeated Measures ANOVA of mean daily latencies showed that rats with lesions of the MFC had a deficit in the water task that persisted throughout the training period ($p = 0.029, p = 0.002, p = 0.248, p = 0.041, p = 0.044, p = 0.038, p = 0.048$, respectively). In contrast, PreFGF lesion rats showed no significant difference in

the time it took to locate the platform on any day relative to controls ($p = 0.849$, $p = 0.269$, $p = 0.589$, $p = 0.510$, $p = 0.471$, $p = 0.561$, $p = 0.540$, respectively). The PreFGF controls were comparable to the untreated controls on every day (p 's > 0.100).

Latencies were unrelated to the swimming speed of the rats as there were no differences among groups (see Figure 4-11). A One-way ANOVA showed no main effect of group, $F(3,38) = 0.975$, $p = 0.415$. LSD post hoc analysis revealed no differences between groups (p 's > 0.10).

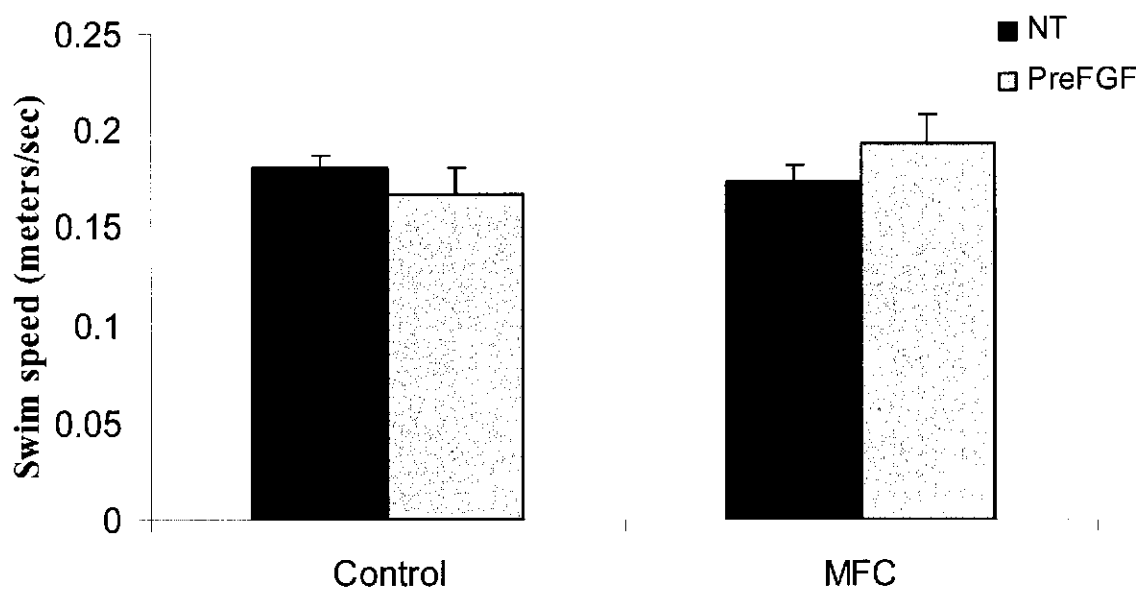
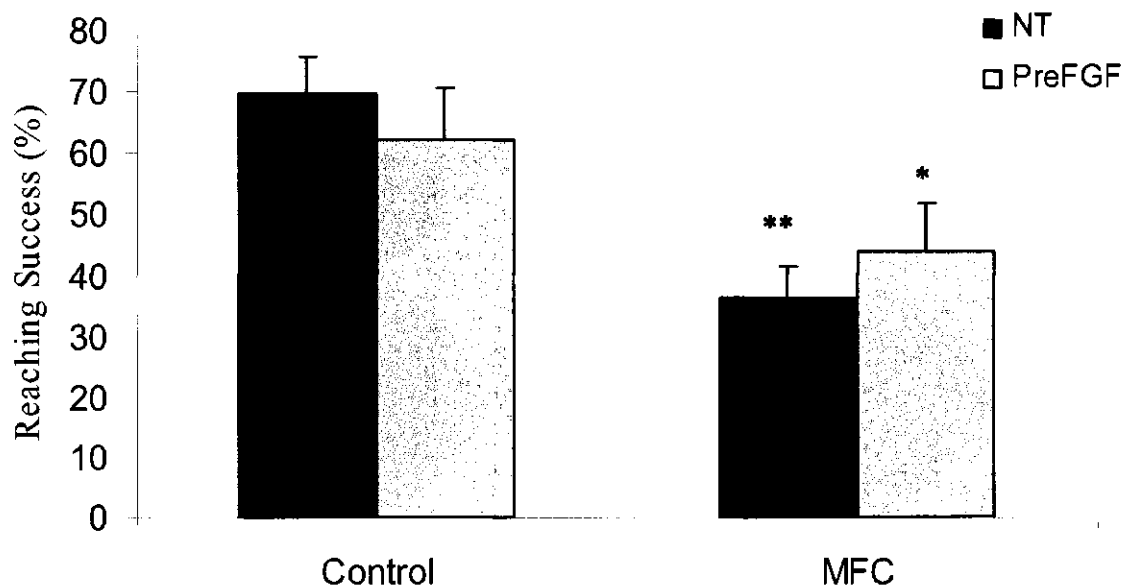

Figure 4-11 Summary of mean swim speeds

4.3.2.2. *Whishaw Tray Reaching task*

Rats with lesions of the MFC showed impairments in the reaching task. Although the PreFGF lesion rats had a slightly higher rate of success in obtaining the food pellets, their performance remained impaired relative to the controls (see Figure 4-12).

An ANOVA revealed a main effect of lesion, $F(1,37) = 12.32, p = .001$, but no effect of treatment, $F(1,37) = 0.000, p = 0.987$, nor the interaction, $F(1,37) = 1.024, p = 0.318$.



* significantly different from NT Controls at $p < 0.05$
 ** significantly different from NT Controls at $p < 0.001$

Figure 4-12. Mean percentage of successful reaching attempts

4.3.2.3. Open Field

MFC lesions produced no overall changes in activity level relative to controls (see Table 4-5). Prenatal treatment of FGF-2, however, increased the level of activity of sham lesion rats, and further increased activity in rats with MFC lesions. An ANOVA with lesion and treatment as variables showed a significant main effect of treatment, $F(1,25) = 15.53, p = .001$, but no main effect of lesion, $F(1,25) = 0.959, p = 0.357$, nor the interaction, $F(1,25) = 1.769, p = 0.196$. A Fisher's LSD showed that rats with prenatal treatment of FGF-2 had a higher level of activity than either the NT MFC lesion rats ($p = 0.008$) or the controls ($p = 0.011$). The NT MFC rats did not differ from the controls ($p = 0.994$).

Table 4-5. *Summary of mean activity level*

Group	Activity Level	
	NT	FGF-2
Control	459.5 ± 28	578.9 ± 56
MFC	443.5 ± 38	684.6 ± 53*†

**significantly different from NT Controls at $p \leq 0.05$*

†significantly different from NT MFC group at $p \leq 0.05$

Experiment 3.2. Posterior Parietal Cortical Lesions

4.3.3. ANATOMICAL RESULTS

4.3.3.1. General Observations

A dorsal view of a typical P3 PPC lesion in adulthood shows that the cortex is shrunken, exposing a large area of the midbrain (see arrow ▲) when compared to a typical sham control brain (see Figure 4-13). Although the cortex has collapsed inward, lesion areas are still visible (see arrow ↑). The shrinkage did not appear to be a result of any undeveloped brain regions, as even the most posterior neocortex (occipital lobe) is present. Rather, there was an overall shrinkage that extended from the anterior to posterior cortex.

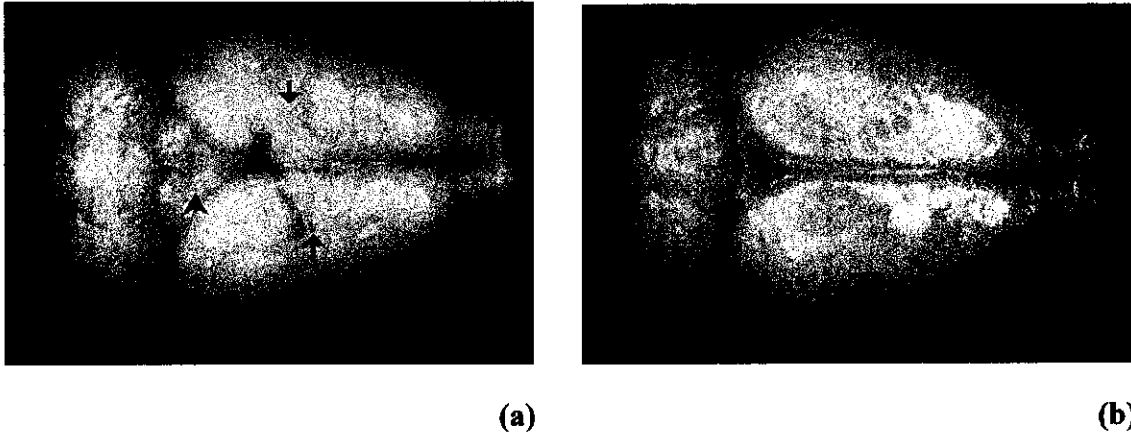

Figure 4-13 Dorsal view of brain from a PPC lesion (a) and sham control (b). (midbrain = ▲; lesion areas = ↑).

4.3.3.2. Body Weight

Lesions of the PPC did not influence body weight of either male or female lesion rats in adulthood relative to controls, whether or not they had received PreFGF treatment (see Table 4-6). An ANOVA of female body weight showed that there was no main effect of lesion, $F(1,19) = 0.094$, $p = 0.762$, no main effect of treatment, $F(1,19) = 0.572$, $p = 0.459$, nor the interaction, $F(1,19) = 0.634$, $p = 0.436$. Students' t -tests of male body weight showed no significant difference between untreated control and PPC lesion rats, $t(9) = 0.119$, $p = 0.908$, nor between controls and PreFGF PPC lesion males, $t(5.042) = 0.446$, $p = 0.674$. There were no other differences among groups of either sex (p 's > 0.100).

Table 4-6 Summary of mean body weight for each sex

Group	Body Weight (grams)	
	Male	Female
NT Control	436 ± 34	287.05 ± 11
NT PPC	431 ± 29	281.56 ± 8
PreFGF Control	408 ± 7	286.60 ± 8
PreFGF PPC	453 ± 12	298.20 ± 12

4.3.3.3. Brain Weight

Sexes were analyzed separately. Brain weight was lower in both male and female rats with early PPC lesions, whether or not they had received FGF-2 treatment. Although, the brain weight of females with PPC lesions was unaffected by FGF-2, the treatment did increase brain weight in males with PPC lesions (see Table 4-7).

Table 4-7 Summary of mean brain weights

Group	Brain Weight (grams)	
	Male	Female
NT Control	1.75 ± 0.04	1.54 ± 0.04
NT PPC	1.49 ± 0.02**	1.41 ± 0.03*
PreFGF Control	1.67 ± 0.02	1.59 ± 0.02
PreFGF PPC	1.58 ± 0.05**†	1.38 ± .043*

* significantly different from NT Controls at $p \leq 0.05$

† significantly different from NT PPC group at $p \leq 0.05$

** significantly different from NT Controls at $p \leq 0.001$

ANOVA's for each sex with treatment and lesion as variables showed a main effect of lesion for males, $F(1,16) = 34.91, p = 0.000$, and females, $F(1,18) = 21.43, p = 0.000$, but no main effect of treatment for the males, $F(1,16) = 0.001, p = 0.997$, nor females, $F(1,18) = 0.085, p = 0.774$. An unexpected finding was the interaction of lesion and treatment for the males, $F(1,16) = 7.98, p = 0.012$, but not females, $F(1,18) = 1.11, p = 0.305$. Fisher's LSD tests showed that males with PPC lesions, regardless of treatment, had significantly lighter brains relative to controls (p 's = 0.000). Yet, in males FGF-2 produced an increase in brain weight, as the FGF-2 PPC males had significantly heavier brains than the NT PPC males ($p = 0.037$). The females with PPC lesions, whether or not they had received PreFGF treatment, had significantly lighter brain weights relative to controls ($p = 0.000$), but no differences were found between the two treatment groups ($p = 0.305$).

4.3.3.4. Cerebellum SA

Lesions of the PPC did not have an impact on cerebellum size in adulthood as shown by measurements of the dorsal cerebellum surface area (SA). PreFGF treatment had a differential affect however, as it substantially increased cerebrum SA in the lesion rats but not in the control rats (see Table 4-8). An ANOVA with lesion and treatment as variables showed a main effect of treatment, $F(1,26) = 5.158, p = 0.032$, but only a trend of main effect for lesion, $F(1,26) = 3.32, p = 0.080$, and no interaction, $F(1,26) = 0.588, p = 0.450$. A Fisher's LSD showed a significant increase in cerebellum size in the PreFGF PPC rats relative to both the controls and the untreated lesion animals ($p = 0.012$ & $p =$

0.027, respectively). There were no other significant differences among the groups (p 's > 0.100).

Table 4-8. *Summary of the mean dorsal surface area of the cerebellum in pixels²*

Group	Cerebellum SA (pixels ²)	
	NT	PreFGF
Control	352.04 ± 6.57	359.59 ± 4.31
PPC	357.33 ± 5.59	372.59 ± 3.05*†

* significantly different from Controls at $p \leq 0.05$

† significantly different from NT MFC at $p \leq 0.05$

4.3.3.5. Cortical SA

Lesions of the PPC produced an overall shrinkage in dorsal cortical surface area (SA) relative to control rats. PreFGF treatment did not appear to have an affect on cortical SA, as both the treated controls and treated lesion rats were comparable to their no treatment counterparts (Figure 4-14). An ANOVA with group and treatment as variables showed a main effect of lesion, $F(1,26) = 15.78$, $p = 0.001$, but no main effect of treatment, $F(1,26) = 0.065$, $p = 0.800$, nor the interaction, $F(1,26) = 0.000$, $p = 0.984$. A Fisher's LSD showed that the dorsal cortical SA of both untreated and treated lesion rats was significantly shrunken relative to controls ($p = 0.013$ & $p = 0.010$, respectively).

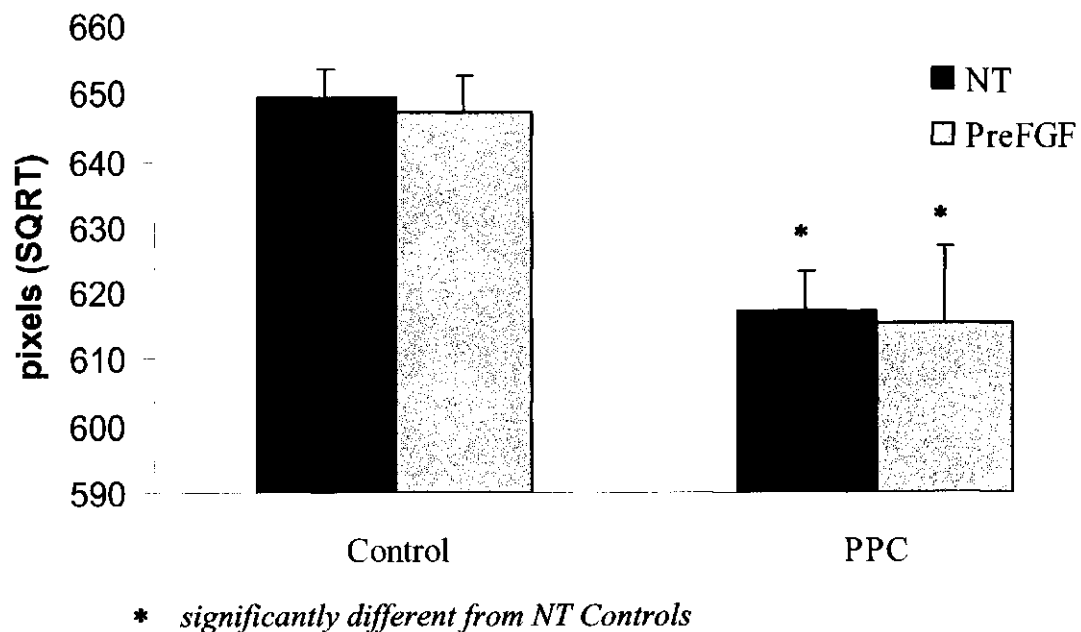

Figure 4-14. Graph of the mean surface area of the dorsal cortex in pixels²

4.3.3.6. Cortical Thickness

In general, rats with PPC lesions had a thinning of the cortical mantle that was mainly restricted to the medial cortex (see Figure 4-15a), whether or not they had received PreFGF treatment. Lesion rats showed slight differences in thickness of the lateral cortex (see Figure 4-15b) relative to controls, with untreated lesion rats showing an increase on Plane 2, and PreFGF lesion rats showing a slight thinning of the lateral cortex on Planes 2 and 5. The only apparent affect of Pre FGF-2 treatment on cortical thickness in control rats, was a modest decrease in the ventral cortex (see Figure 4-15c) on Plane 2.

A Repeated-measures ANOVA of the **medial cortex** (Figure 4-15a) showed a main effect of lesions, $F(1,20) = 15.81, p = 0.001$, but not treatment, $F(1,20) = 0.030, p = 0.863$, nor the interaction, $F(1,20) = 0.664, p = 0.425$. A Fisher's LSD showed that there was significant reduction in cortical thickness on Plane 2 and 3, and a trend in reduction

on Plane 5, in the NT lesion rats relative to controls ($p = 0.005$, $p = 0.000$, and $p = 0.073$, respectively). Similarly, PreFGF rats had a decrease in cortical thickness on Planes 2, 3 and 5 ($p = 0.019$, $p = 0.030$, and $p = 0.009$, respectively). There were no other differences among the groups (p 's > 0.100)

A Repeated-measures ANOVA of the **lateral cortex** (Figure 4-15b) with lesion and treatment as variables showed a main effect of lesion, $F(1,23) = 12.107$, $p = 0.002$, but not treatment, $F(1,23) = 0.364$, $p = 0.552$, nor the interaction, $F(1,23) = 0.000$, $p = 0.986$. A Fisher's LSD showed that the only significant reduction in cortical thickness of the lateral cortex in PPC lesion rats was on Plane 2 ($p = 0.013$), although there was a decrease in Planes 3 and 4 lateral cortex, it did not reach significance ($p = 0.090$ & $p = 0.071$, respectively). Similarly, PreFGF lesion rats had a moderate decrease in lateral cortex on Planes 2 and 5, but they also did not reach significance ($p = 0.067$ & $p = 0.071$, respectively).

A Repeated-measures ANOVA of **ventral cortex** (Figure 4-15c) with lesion and treatment as variables showed no main effect of lesion, $F(1,24) = 1.591$, $p = 0.219$, no main effect of treatment, $F(1,24) = 0.541$, $p = 0.469$, and no interaction, $F(1,24) = 0.979$, $p = 0.332$. A Fisher's LSD showed a reduction in the ventral cortex on Plane 2 in both the NT PPC and PreFGF PPC rats ($p = 0.024$ & $p = 0.048$, respectively). There were no other significant differences among the groups (p 's > 0.100).

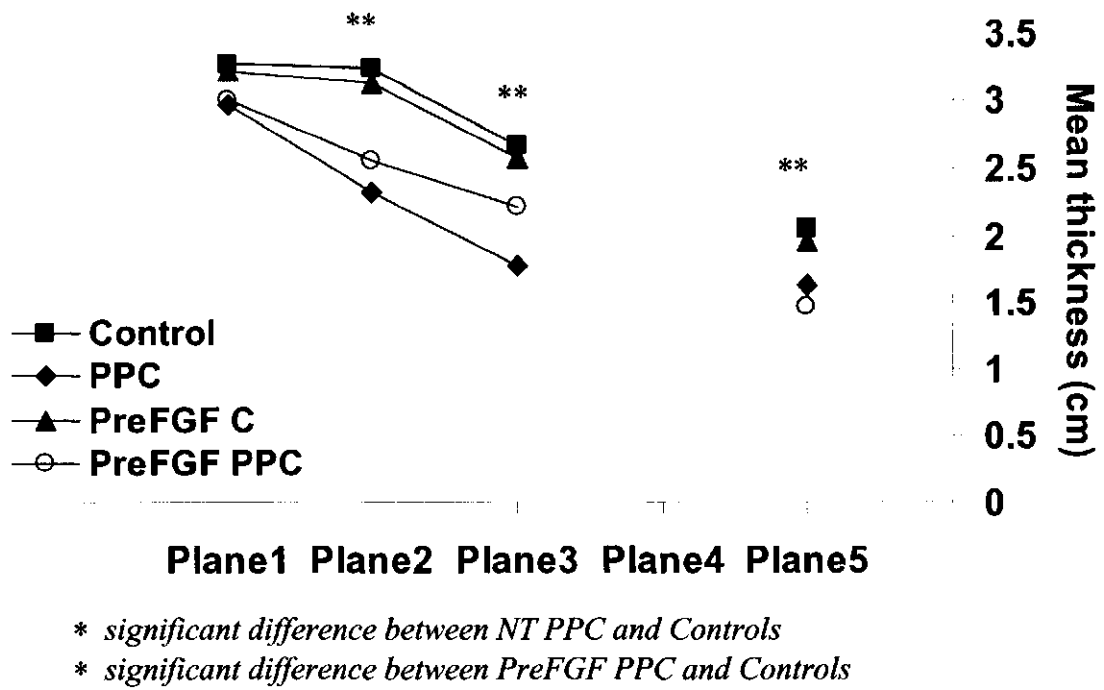

Figure 4-15a Medial Cortex

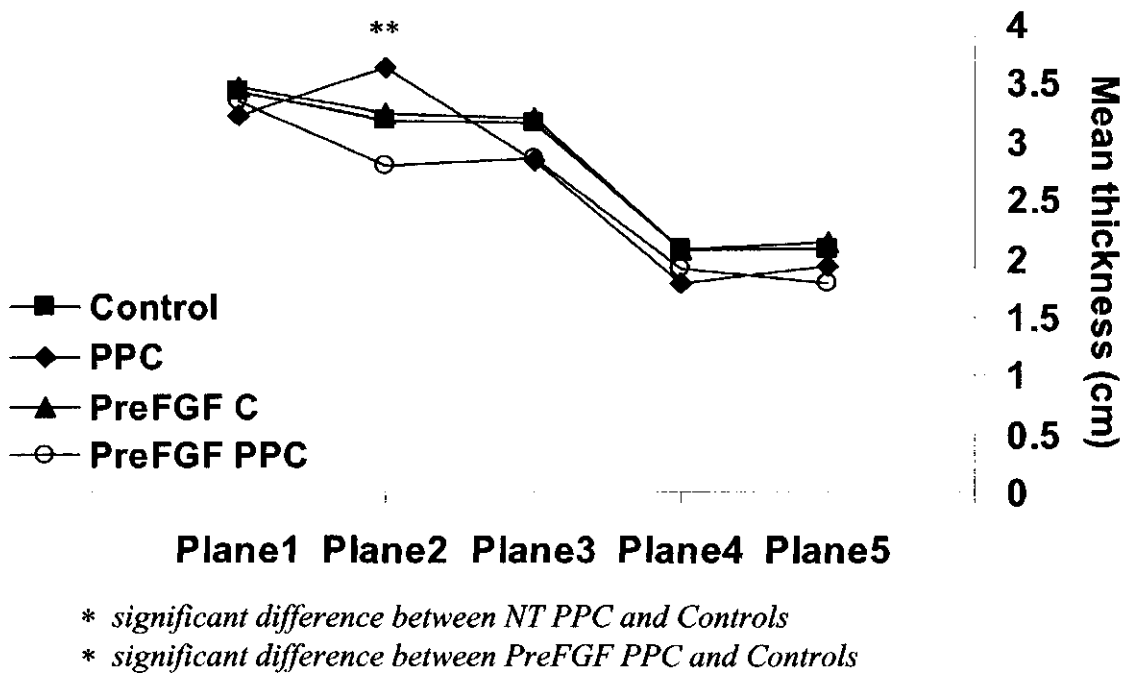
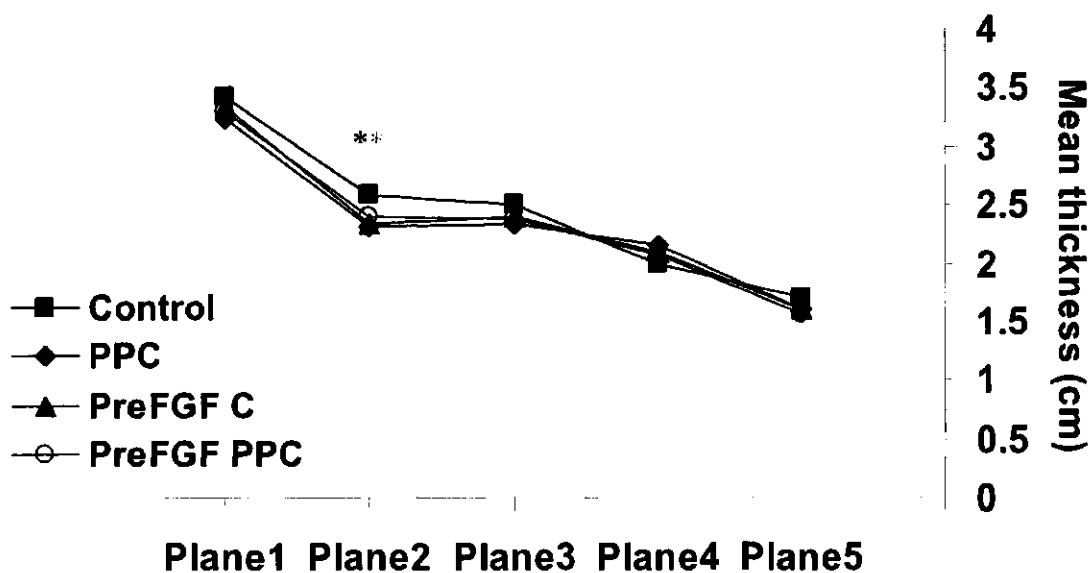

Figure 4-15b Lateral Cortex



- * significant difference between NT PPC and Controls
- ** significant difference between PreFGF and NT Controls

Figure 4-15c Ventral Cortex

Figure 4-15 Graphs depicting mean cortical thickness on five different planes for three different cortical areas (a) medial cortex, (b) lateral cortex, (c) ventral cortex. Mean lateral cortical thickness for each plane

4.3.3.7. Anterior and Posterior Thalamic Cross-sectional Area

Rats with lesions of the PPC had a shrunken anterior thalamic cross-sectional area, whether or not they had been treated with FGF-2. Posterior thalamic measures, on the other hand, did not differ among any groups (see Table 4-9). An ANOVA of anterior thalamic cross-sectional area with lesion and treatment as variables revealed a significant main effect of lesion, $F(1,25) = 11.77, p = 0.002$, but no main effect of treatment, $F(1,25) = 0.391, p = 0.537$, nor the interaction, $F(1,25) = 0.413, p = 0.526$. An ANOVA of posterior thalamic cross-sectional area revealed only a marginal main effect of lesion,

$F(1,25) = 3.63, p = 0.068$, (PPC < Controls) , and no main effect of treatment, $F(1,25) = 1.55, p = 0.244$, nor the interaction, $F(1,25) = 0.428, p = 0.665$.

Table 4-9 *Summary of mean cross-sectional measurements of the anterior and posterior thalamus.*

Mean Thalamic Cross-sectional Measurements (mm²)		
Group	Anterior	Posterior
NT Controls	18.37 ± 0.64	30.11 ± 1.05
PreFGF C	17.20 ± 1.11	31.94 ± 0.99
NT PPC	14.63 ± 0.74*	28.91 ± .0.81
PreFGF PPC	14.64 ± 0.84*	29.48 ± .92

* significantly different from NT Controls at $p \leq .05$

4.3.3.8. Lateral Posterior Thalamic Nuclei

In rats with lesions of the PPC on P3 there was an overall disorganization of the posterior thalamic nuclei, such that the LP was most often indistinguishable (see Figure 4-16a & 4-17a). As well, there appeared to be gliosis in the area that corresponds to the LP. Treatment with prenatal FGF-2 appeared to be somewhat beneficial in lesion rats as there was now a distinguishable LP, although the cells within the LP were disorganized (see Figure 4-19a & c). In contrast, prenatal FGF-2 appeared to be disadvantageous to the development of the LP in control rats, as although the cells did appear normal they showed an organization that was not present in the NT controls (see Figure 4-18a & c).

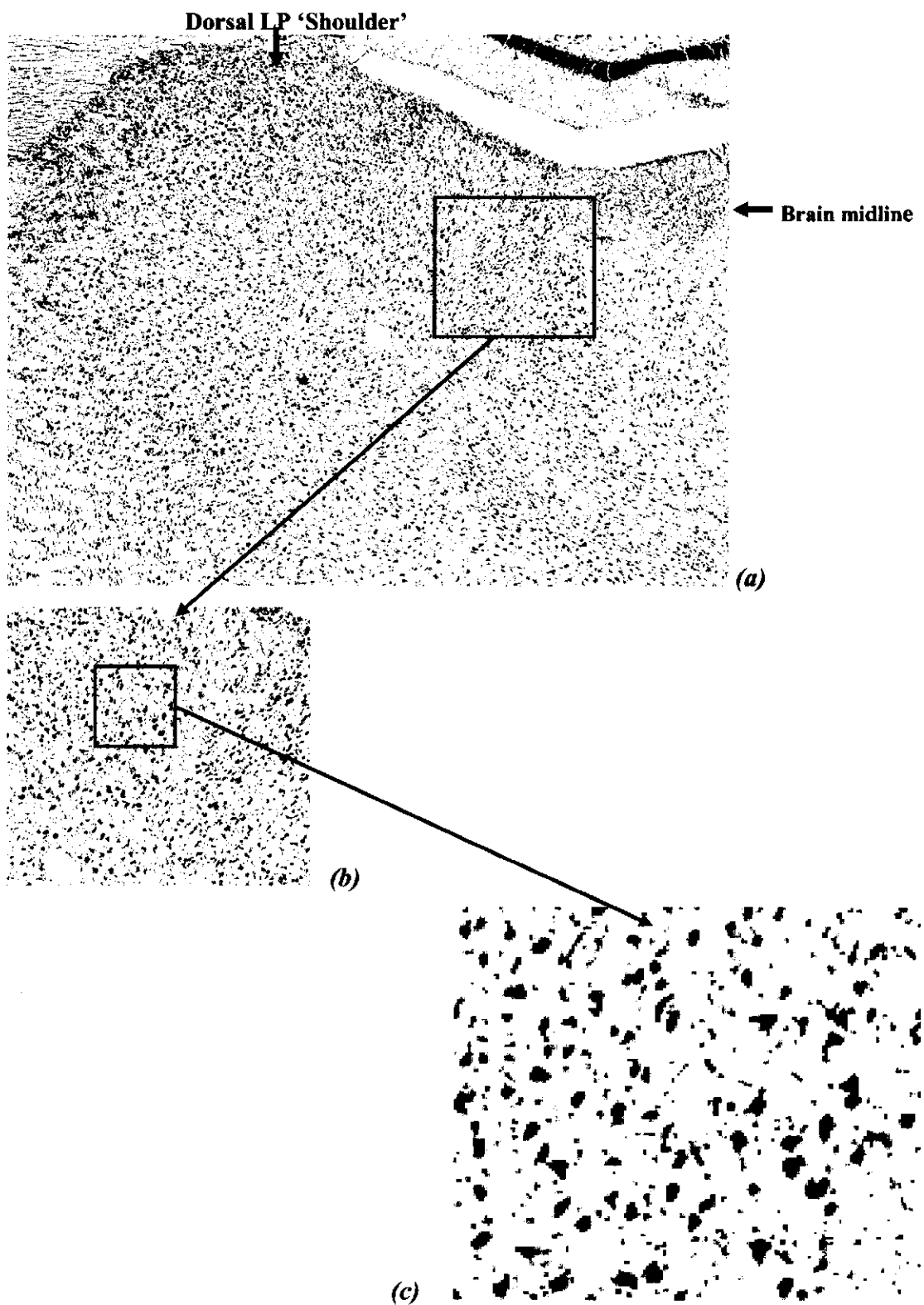

Figure 4-16 *NT Control (a) The LP of a treated rat magnified to 5X (b) excerpt of above magnified (200X) to illustrate cell organization within the LP, and (c) an enlarged excerpt to illustrate cell form and type*

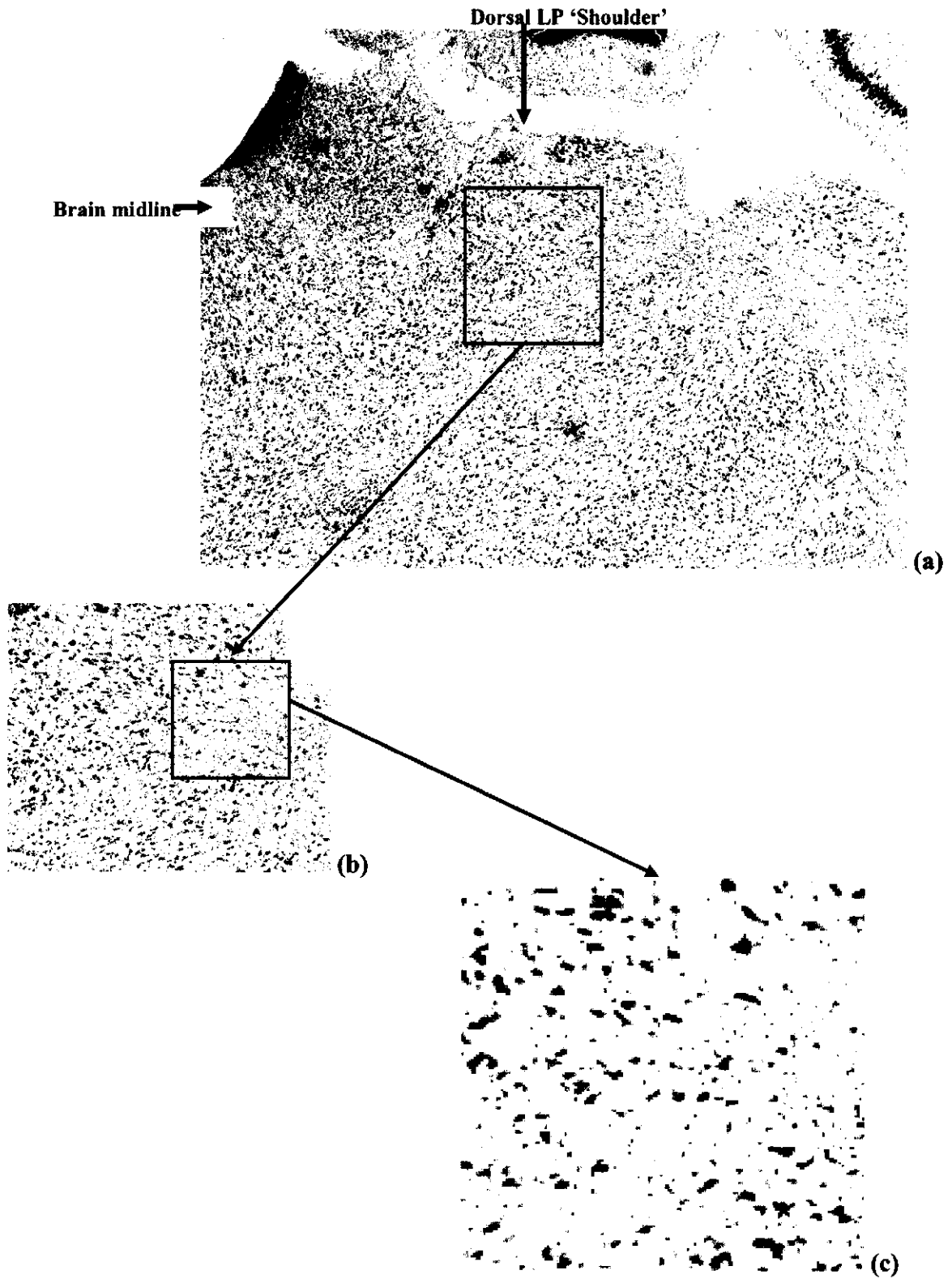

Figure 4-17 *NT PPC (a) The LP of a treated rat magnified to 5X (b) excerpt of above magnified (200X) to illustrate cell organization within the LP, and (c) an enlarged excerpt to illustrate cell form and type*

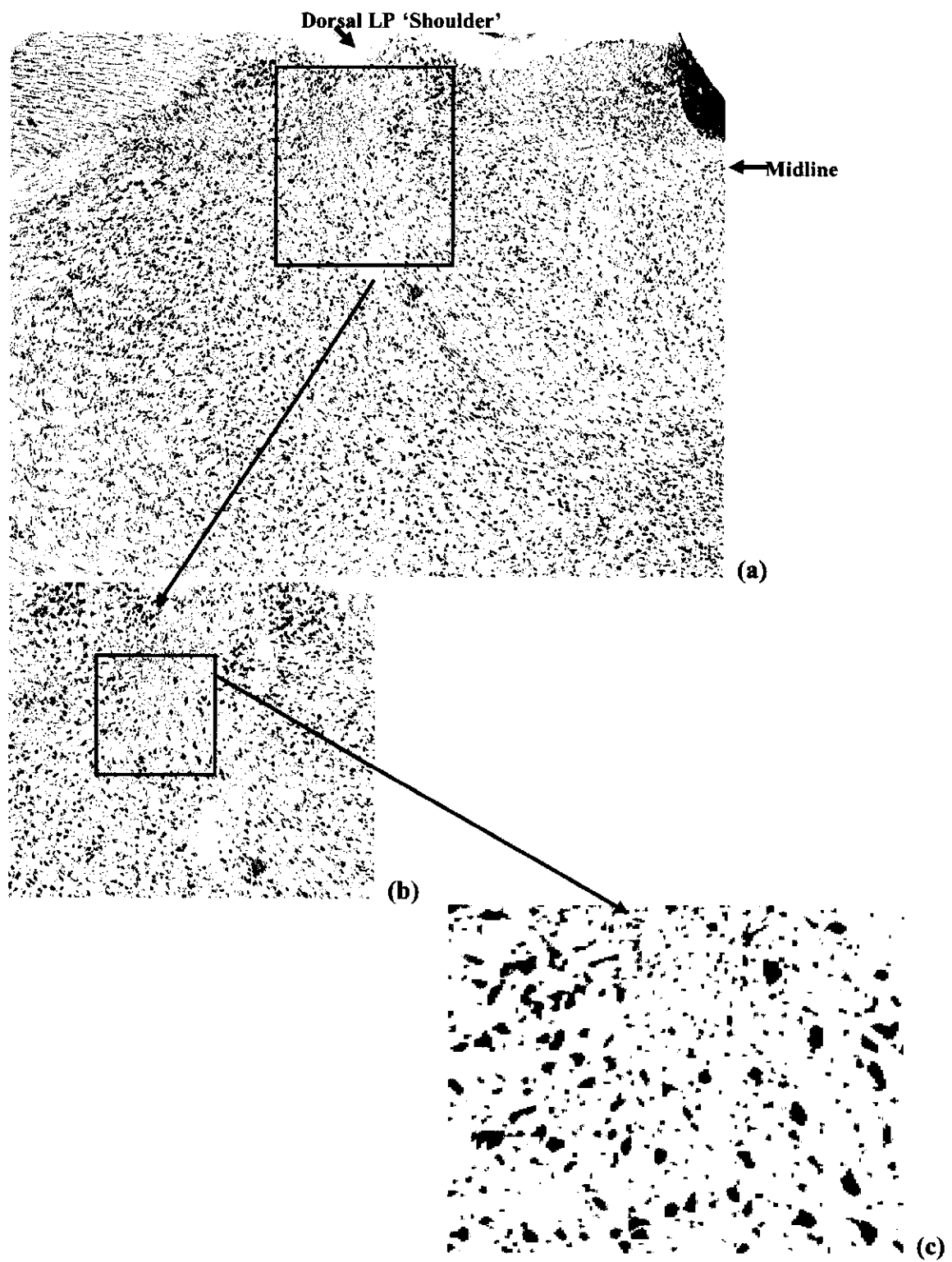

Figure 3-18 *PreFGF Control* (a) The LP of a treated rat magnified to 5X (b) excerpt of above magnified (200X) to illustrate cell organization within the LP, and (c) an enlarged excerpt to illustrate cell form and type

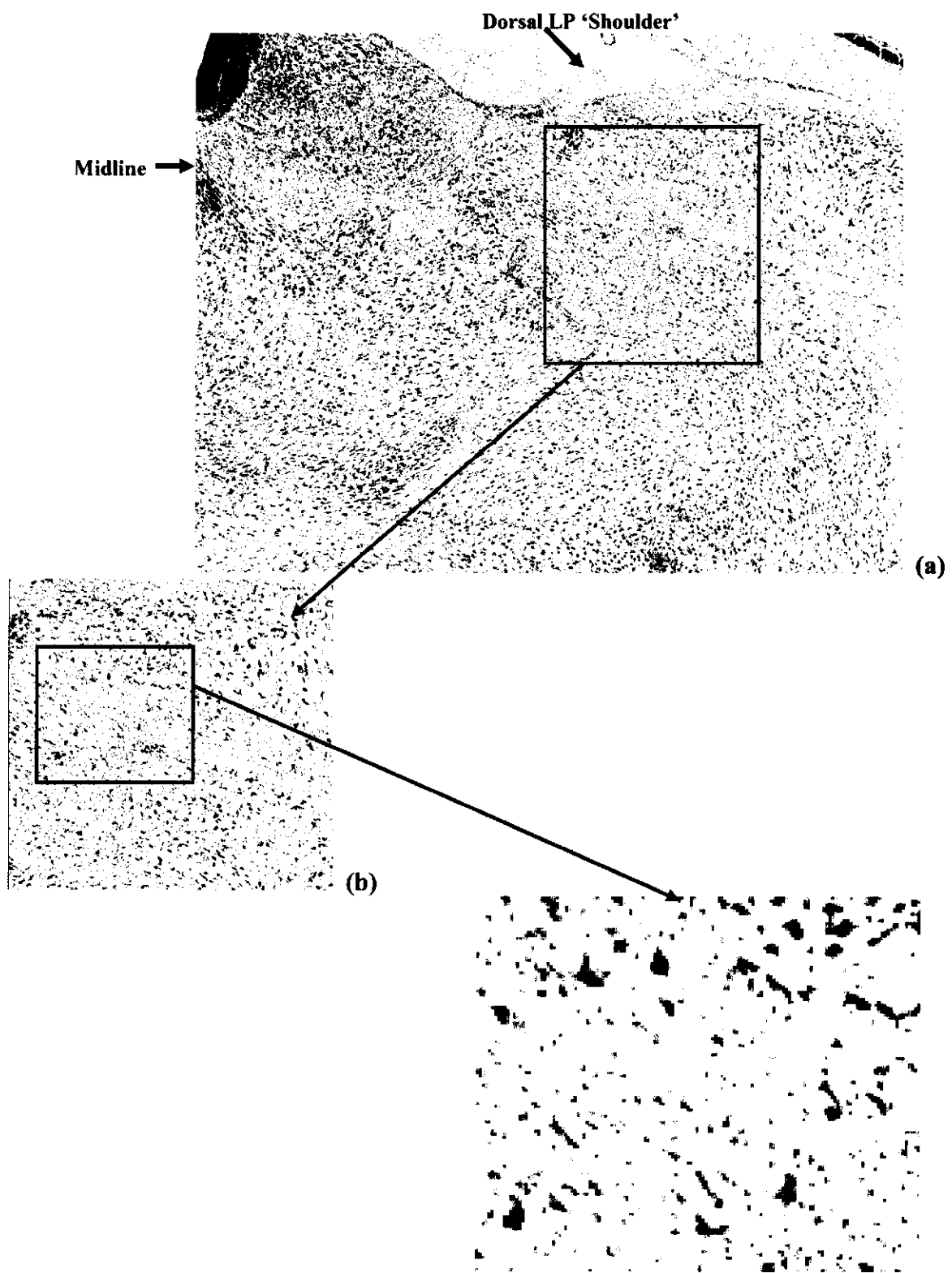

Figure 3-19 *PreFGF PPC (a) The LP of a treated rat magnified to 5X (b) excerpt of above magnified (200X) to illustrate cell organization within the LP, and (c) an enlarged excerpt to illustrate cell form and type*

4.3.4. BEHAVIORAL RESULTS

4.3.4.1. Morris Water Maze

The results of sum latency scores showed that rats with PPC lesions were impaired at the water task relative to controls, whether or not they had prenatal treatment of FGF-2 (see Figure 4-20).

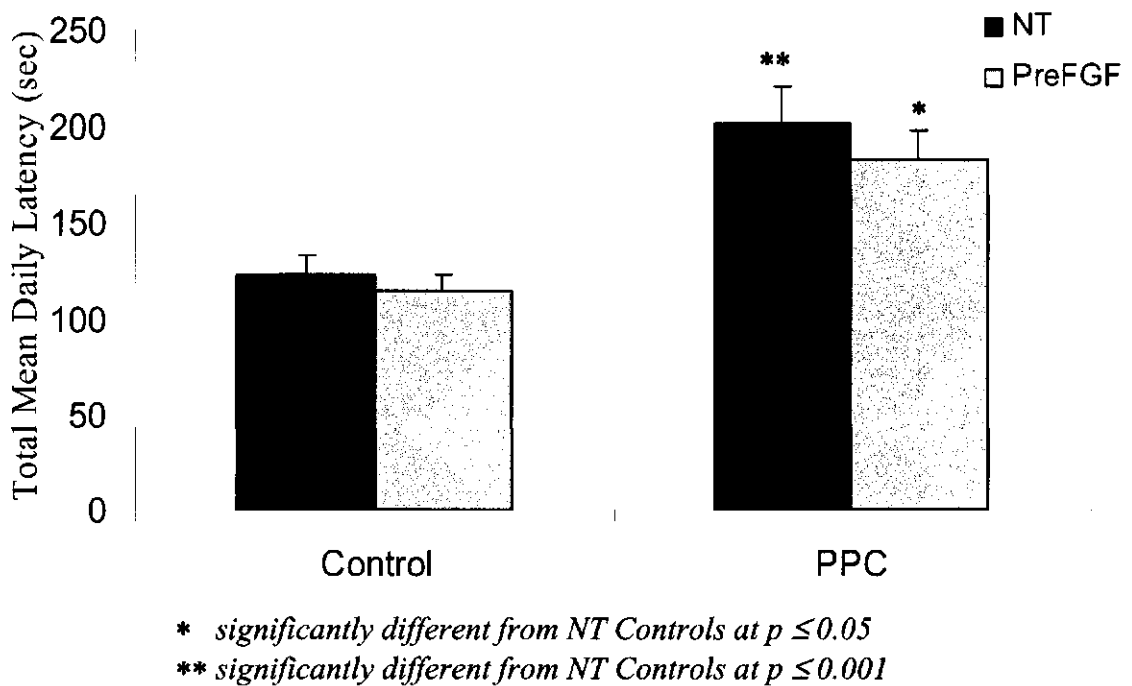
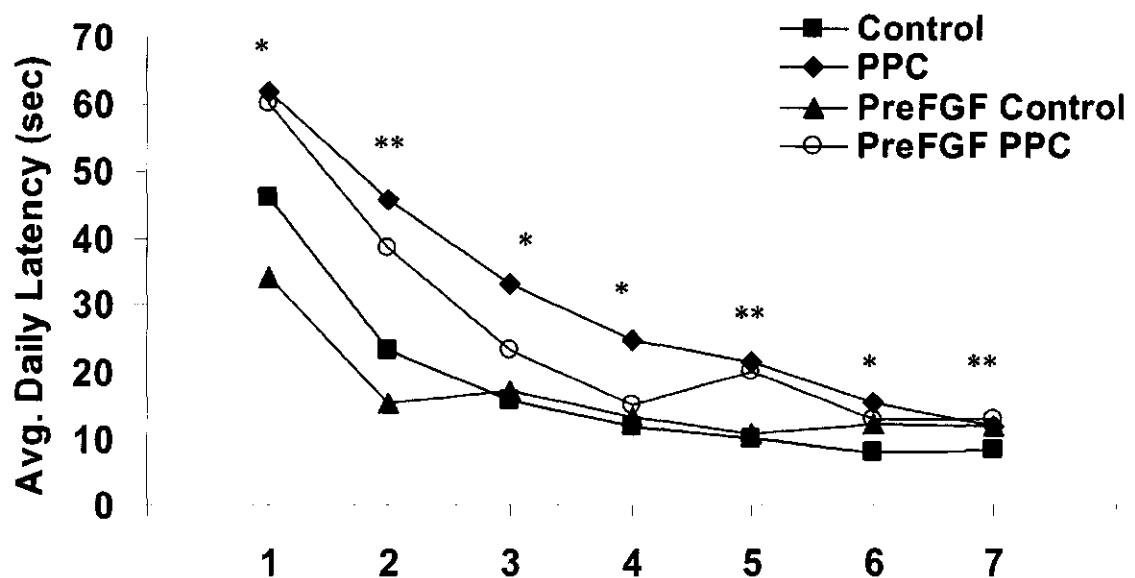

Figure 4-20. Total mean latency over 7 days (trial blocks)

Yet, the performance of the PreFGF PPC rats was comparable to controls on five out of the seven trial blocks (see Figure 4-21). In contrast, the NT PPC rats remained impaired on each trial block relative to controls. The only difference between the treated and untreated controls was a slight increase in latency on Day 7 for the PreFGF rats relative to controls.



* significant difference between NT MFC and NT Controls
 * significant difference between NT MFC and FGF MFC rats

Figure 4-21. Mean latencies for each trial block

An ANOVA of total mean latencies over seven trial blocks with lesion and treatment as variables showed a main effect of lesion, $F(1,40) = 21.80, p = 0.000$, but not treatment, $F(1,40) = 0.703, p = 0.407$, nor the interaction, $F(1,40) = 0.100, p = 0.754$. A Fisher's LSD of a Repeated Measures ANOVA of each day showed that lesions of the PPC produced a significant impairment on every trial block relative to controls ($p = 0.028, p = 0.003, p = 0.011, p = 0.005, p = 0.009, p = 0.004, p = 0.025$, respectively). In contrast, PreFGF PPC rats showed a significant deficit in the task on Days 5 & 7 only, although there was a moderate increase in latency relative to controls on Day 2 as well ($p = 0.104, p = 0.078, p = 0.347, p = 0.534, p = 0.046, p = 0.100, p = 0.017$, respectively). PreFGF controls were comparable to untreated controls on all days (p 's > 0.100) with the

exception of Day7 ($p = 0.55$), in which they showed a marginally significant deficit in the time to find the platform.

The results of latency to find the platform was unrelated to differences in swimming speed among the groups (see Figure 4-22). An ANOVA showed no main effect of lesion, $F(1,41) = 1.892$, $p = 0.177$, nor treatment, $F(1,41) = 1.015$, $p = 0.320$, nor interaction, $F(1,41) = 0.257$, $p = 0.615$.

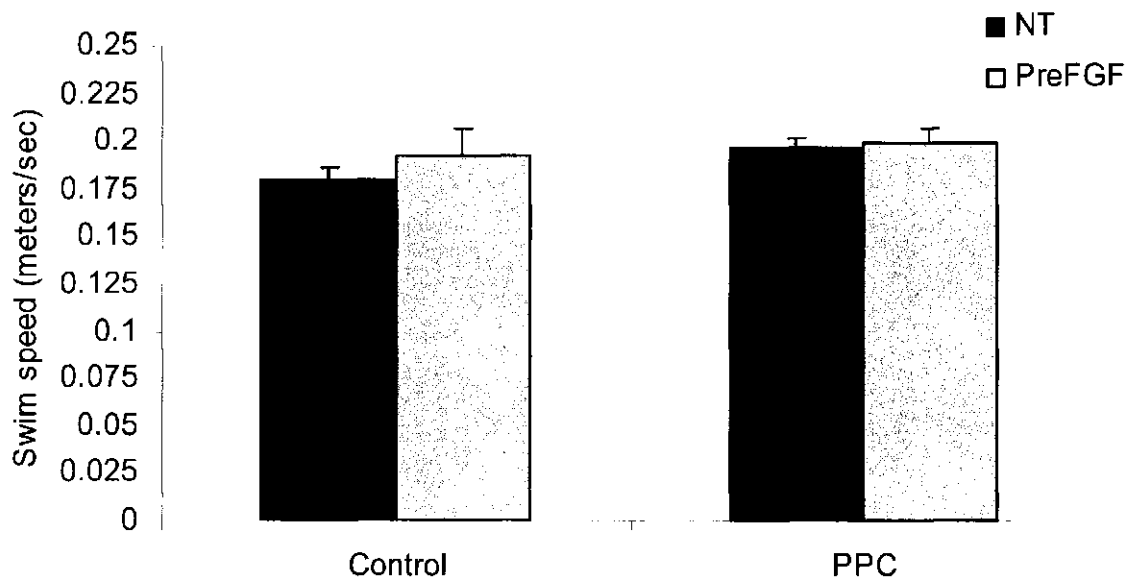

Figure 4-22. Mean swimming speed per group

4.3.4.2. *Whishaw Tray Reaching Task*

Lesions of the PPC did not produce deficits in skilled forelimb use in the tray reaching task (see Figure 4-23). The lesions animals were able to perform the task comparable to controls and no influence of prenatal FGF-2 treatment was found. An ANOVA with lesion and treatment as variables showed no main effect of lesion, $F(1,40) = 0.251$, $p =$

0.619, nor treatment, $F(1,40) = 0.015$, $p = 0.904$, and no interaction, $F(1,40) = 1.748$, $p = 0.194$.

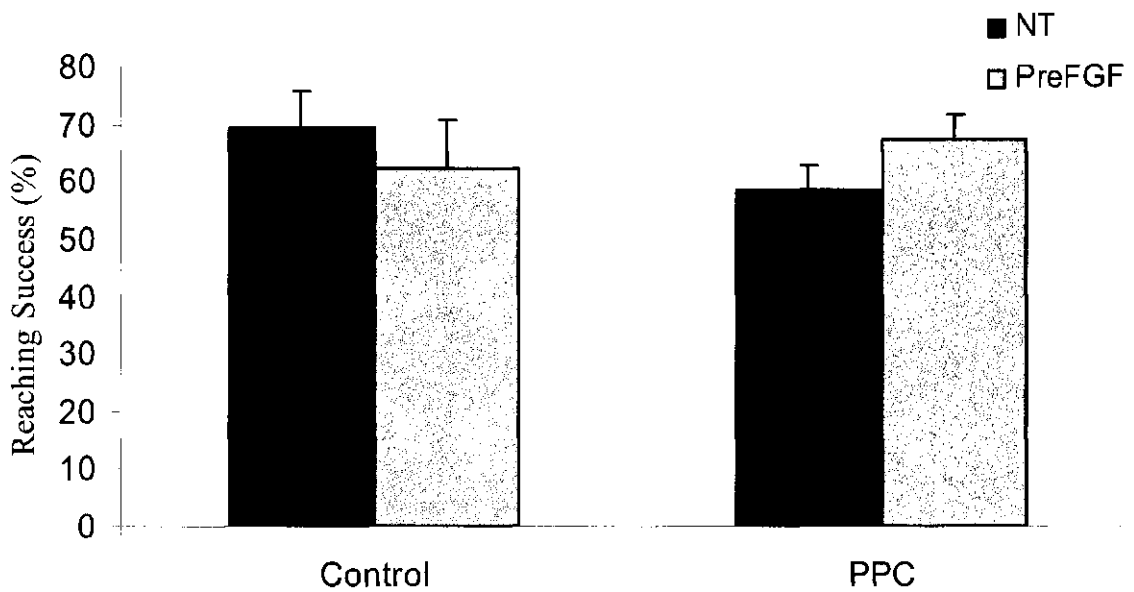
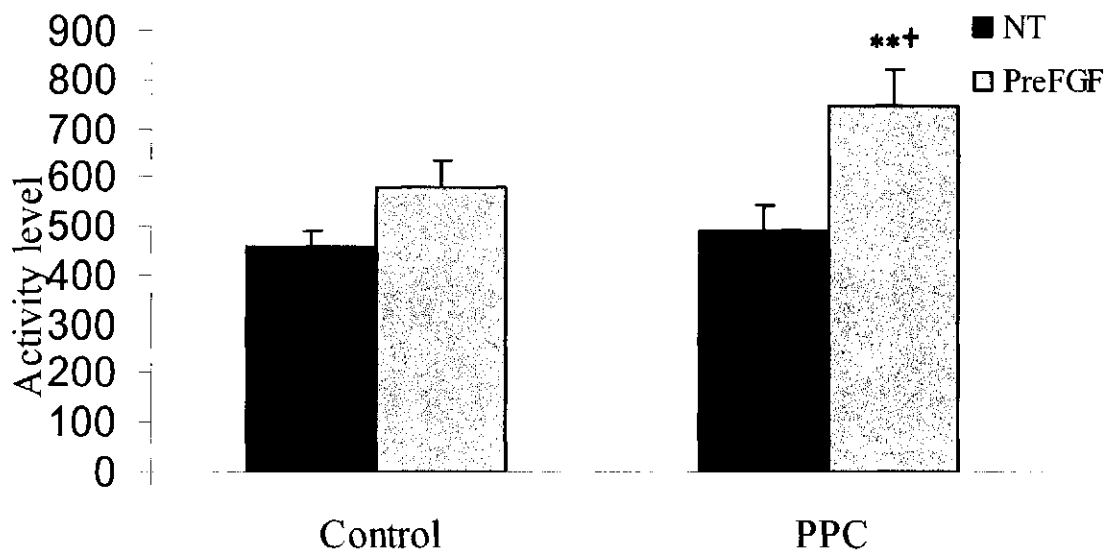

Figure 4-23 Mean percentage of successful attempts at reaching food pellets.

4.3.4.3. Open Field

Rats with lesions of the PPC did not show any difference in level of overall activity. Prenatal treatment of FGF-2 did, however, increase activity measures in both the sham and PPC lesion rats. Sham lesion rats experienced a moderate increase, whereas rats with PPC lesions had a substantial increase in activity (see Figure 4-24). An ANOVA showed a main effect of treatment, $F(1,28) = 11.208$, $p = 0.002$, but not lesion, $F(1,28) = 3.017$, $p = 0.093$, nor the interaction, $F(1,28) = 1.507$, $p = 0.230$. A Fisher's LSD test revealed that the PreFGF PPC rats were significantly more active than either the NT Controls or the NT PPC rats ($p = 0.001$ & $p = 0.003$, respectively).



† significantly different from NT MFC group at $p \leq 0.05$
 ** significantly different from NT Controls at $p \leq 0.001$

Figure 4-24 Mean overall activity measures for each group

4.4. DISCUSSION

Two experiments were used to examine the potential of prenatal FGF-2 in the enhancement of functional recovery following either bilateral medial frontal or bilateral posterior parietal cortical lesions at postnatal day 3 (P3). Table 4-10 summarizes the anatomical and behavioral results.

Table 4-10 Summary of results from Experiment 3.1 and 3.2

(❖◆) significantly decreased/increased compared to NT Lesion counterpart; (❖◆) significant decrease/increase compared to NT Control group; (⊞) no significant difference relative to controls; (NA) not applicable.

Abbreviations: M (medial cortex), L (lateral cortex) V (ventral cortex).

Note: For changes in cortical plane to be considered significant, a minimum of 2 or more of the 5 planes must have differed in the medial, lateral or ventral cortex. C = Control.

RESULTS:	Anatomical								Behavioral		
	<u>Body Wt</u>	<u>Brain Wt</u>	<u>Cerebellum</u>	<u>Cortex SA</u>	<u>Lesion SA</u>	<u>Cortical Planes</u>	<u>Thalamus</u>	<u>Brain Stem</u>	<u>Water task</u>	<u>Reaching</u>	<u>Open field</u>
NT MFC	⊞	❖	⊞	❖	⊞	❖ MLV	❖	❖	❖	❖	⊞
PreFGF MFC	⊞	❖◆ ⊞	◆	⊞	⊞	❖ M	❖	⊞	⊞◆	❖	◆◆
PreFGF C	⊞	⊞	⊞	⊞	NA	⊞	⊞	⊞	⊞	⊞	⊞
NT PPC	⊞	❖	⊞	❖	NA	❖ M	❖	⊞	❖	⊞	⊞
PreFGF PPC	⊞	◆◆	◆	❖	NA	❖ M	❖	⊞	◆◆	⊞	◆◆

Overall, the main results of the present study were: 1) Postnatal day 3 lesions of both the MFC and the PPC produced impairments in learning of the Morris Water task and MFC

lesions alone showed lower performance levels on the Whishaw Reaching task; 2) Both MFC and PPC lesions led to a reduced thickness of the cortical mantle, lower brain weight, and a reduction of anterior and posterior thalamic cross-sectional areas; 3) Treatment with prenatal FGF-2 (PreFGF) reduced learning deficits in both the MFC and PPC treated rats, but did not improve skilled reaching in treated MFC lesion animals; 4) Anatomical correlates of functional recovery were found in the treated MFC rats, and to a lesser extent in the treated PPC lesion rats. Each finding will be discussed in turn.

4.4.1. Effects of postnatal day 3 MFC and PPC lesions on cognitive and motor tasks.

The cognitive and motor deficits that have previously been reported following MFC and PPC on postnatal day 3 (P3) were also found in the current experiment (King & Corwin, 1992; Kolb, Sutherland & Whishaw, 1983; Whishaw, Pellis & Gorny, 1992). Rats with either MFC or PPC lesions were impaired in the place task version of the Morris water task, whereas MFC lesion rats, but not PPC lesion rats, were impaired in the Whishaw tray reaching task.

The deficits in the spatial navigation task produced by either MFC or PPC lesions appeared to be related to different mechanisms. The MFC lesion rats appeared to be impaired, not only by the strategy used for locating the platform, but also in the ability to retain the information regarding the platform location. These impairments were exemplified by the 'looping' strategy adopted by MFC rats. In contrast, PPC lesion rats displayed a deficit in relating the relationship of distal cues to platform location, as well as an inability to accurately move their bodies through space. These impairments were

exemplified by the inaccurate heading when initially leaving the pool edge, as well as in the persistent difficulty in locating the platform thereafter.

Lesions of the MFC produced deficits in skilled reaching that was not only apparent in the success in food retrieval as measured in percentage of successful reaches, but also apparent during in visual observations. MFC rats appeared to have great difficulty in closing their extended digits over the food, as well as in manipulation of the food pellets during consumption. Whereas intact rats typically manipulate food pellets with both forepaws during consumption, MFC lesion rats would most often simply eat the bits of food caught between the digits of the reaching paw without manipulating it. Both the deficit in successful reaches and the atypical consumption behavior suggests an extensive deficit in fine motor skills of the forelimbs.

4.4.2. Anatomical irregularities following P3 MFC and PPC lesions

Lesions of both the MFC and PPC produced numerous irregularities in anatomical measures relative to controls. Both lesion groups had lighter brain weights and an overall decrease in dorsal cortical surface area that suggested a substantial loss of cortical cells, as was further evidenced in the reduced cortical mantle of the medial, lateral, and ventral cortices in the MFC lesion rats and in the medial cortex of the PPC lesion rats.

Lesions of the MFC also produced retrograde damage in subcortical regions that receive major projections from the frontal cortex as shown by the shrinkage of anterior and posterior thalamic cross-sectional areas. Similar anatomical irregularities were produced by PPC lesions. The later showed not only shrinkage of the anterior thalamic cross-sectional area, but also a general disorganization of the LP thalamic nuclei. This

disorganization was extensive as often the LP was no longer distinguishable from surrounding nuclei. PPC lesions rats did not show shrinkage in posterior thalamic cross-sectional area as did the MFC lesion rats, suggesting differences in corticospinal connections between the two cortical regions.

4.4.3. Impact of prenatal FGF-2 on behavioral functional outcome

Prenatal treatment of FGF-2 at E15.5 abolished any apparent deficit in the spatial task in rats that had received P3 MFC lesions. As well, looking at the overall total latencies PreFGF PPC lesion showed an improved performance over the untreated lesion animals, although there was still an apparent deficit relative to controls. Yet, in analyzing the daily latencies there was no substantial deficit in the PreFGF lesion rats relative to controls. The cause of this discrepancy is due to the fact that although the PrePPC rats showed an overall deficit over the 7 days, this was an accumulation of modest deficits in each trial block. This phenomenon was replicated in the PreFGF MFC lesion rats as well, although to a lesser extent. This was not the case for either the untreated MFC or PPC lesion rats that showed a persistent impairment over all 7 days of testing.

PreFGF, however, had only a limited impact on fine motor skills following MFC lesions. PreFGF rats, remained impaired relative to controls although they showed a slight increase in performance on the Whishaw tray reaching task that has typically not been found following other treatment strategies. It had been thought that corticospinal connections were not as plastic, thus explaining the absence of motor recovery even when other functions showed behavioral recovery as a result of treatment.

4.4.4. Impact of prenatal FGF-2 on anatomical irregularities

Anatomically, prenatal FGF-2 treatment produced changes in the anatomical measures used following MFC lesions, and to a lesser extent PPC lesions. FGF-2 treated MFC rats showed a decrease in brain weight in males alone, with females showing no decrease relative to controls. As well, cortical surface area in prenatally treated lesion rats was comparable to controls. The diminished loss of cortical area was not related to variance in lesion size between groups as the treated MFC lesion rats had a greater loss than the untreated MFC rats, although the difference was not significant. Decreases in cortical thickness were also less severe in prenatally treated MFC rats, with no apparent decrease in the lateral and ventral cortical mantle. The results of analyses of brain weight, cortex and lesion SA, as well as cortical thickness, suggests a substantial replacement or rescue of cortical neurons and their connections.

The suggested role of FGF-2 in the rescue of thalamic connections, and thus a decrease in retrograde degeneration following early cortical lesions, found only partial support from the present anatomical results. Treatment failed to have an impact on the decrease in anterior thalamic cross-sectional area, whereas the cross-sectional area of the posterior thalamus which is thought to measure thalamocortical connections was comparable to controls. The latter suggests a possible anatomical correlate for the improvement in skilled reaching.

Rats with P3 PPC lesions did not fair so well in anatomical measures. Although there was an increase in brain weight relative to controls which correlated with the modest improvement in the water maze task, PPC lesion rats treated prenatally did not show the vast extent of anatomical changes evident in the MFC lesion group.

5. GENERAL DISCUSSION

If the cerebral cortex of rats is damaged at 7 – 10 days of age there is substantial functional recovery relative to the effects of similar injury either in the first few days of life or in adulthood (Kolb & Whishaw, 1998). A fundamental question for clinicians is whether the recovery that occurs spontaneously after day 7 – 10 lesions might be induced under the right circumstances after earlier lesions. One possible route is to manipulate the levels of neurotrophic factors that are known to be high at this time. A likely neurotrophic candidate is FGF-2, as previous studies have shown that it plays a role in the production and survival of neurons in the intact brain, as well as in the stimulation of functional recovery after cortical injury. The question that was addressed in the current studies was whether increasing endogenous levels of FGF-2, either prenatally or post-injury, might enhance recovery after perinatal injury. This was tested systemically by delivering FGF-2 prior to, or following, postnatal day three (P3) lesions of the medial prefrontal cortex (MFC) or posterior parietal cortex (PPC).

Previous studies have shown that FGF-2 acts under various circumstances to either maintain or enhance neuronal survival. For example, an increased expression of endogenous FGF-2 is shown in and around the lesion site (Liu & Chen, 1994; Reilly & Kumari, 1996). The increased expression of this protein has been associated with a decrease in infarct size following focal cortical lesions in adult rats (Fisher, 1995; Koketsu, Berlove, Moskowitz, Kowall, Caday & Finklestein, 1994). As well, it has been suggested that FGF-2 acts to prevent retrograde damage, such as thalamic degeneration following injury (Yamada, Kinoshita & Kohmura, 1991). Antibodies to FGF-2, *in vitro* and *in vivo*, inhibited proliferation of neuroblasts (Ghosh & Greenberg, 1995; Tao, Black

& Diccico-Bloom, 1997). Further, the use of FGF-2 neutralizing antibodies following focal lesions of the prefrontal motor cortex blocked functional recovery (Rowntree & Kolb, 1997). As well, a study by Vaccarino and colleagues (1999) reported an increase in cortical neurons following prenatal infusion of FGF-2 in rat pups. Developmental studies have also shown good functional recovery following injury at specific postnatal periods of cortical development, namely around P10, whereas a poor outcome follows lesions incurred within the first week of life in the rat pup. One of the distinctive characteristics of recovery from injury at P10 is that it is the time when astrocytes, the major manufacturer of cortical FGF-2, are peaking (Kolb, 2003). It has been suggested that the spontaneous functional recovery following P10 lesions is mediated by the endogenous availability and production of FGF-2 that acts as both a neuroprotective factor, as well as an agent in the production and mitosis of cortical neurons and/or glia that may be regenerated and migrate to the lesion site. Thus it was hypothesized that the application of postnatal exogenous FGF-2 would enhance the functional recovery of an otherwise dismal outcome following P3 lesions of either the MFC or PPC cortex. As well, it was expected that exogenous prenatal application of FGF-2 would increase the number of postnatally available neurons to compensate for those lost due to lesion.

As expected, postnatal treatment of FGF-2 enhanced functional recovery following P3 MFC lesions. In addition, FGF-2 substantially increased functional recovery following P3 lesions of the PPC, although they remained impaired relative to controls. Further, the degree to which postnatal FGF-2 influenced recovery appeared to be dependent on the length of time between being diluted and administered. The greatest

affect in both the MFC and PPC lesion rats was found when FGF-2 was diluted on a daily basis just prior to administration.

One possible explanation for this differential effect of lesion area is that the medial prefrontal cortex draws on the population of still-migrating, undifferentiated neurons of the later developing PPC. As the PPC is one of the last cortical regions to develop, there is a reduced migrating neuronal population to draw on. Along similar lines, the higher level of behavioral functional recovery found in MFC lesion rats, relative to PPC lesion rats, may be due to the transference of MFC functions to neighboring prefrontal cortical regions that have as yet not completed neuronal and functional differentiation.

Whether one or both of these explanations holds true, it was hypothesized that increasing neuronal numbers throughout the cortex would reduce the deficits following either MFC or PPC lesions by offsetting the survival/apoptotic ratio of neurons, thus increasing the number of surviving neurons available to partially compensate for lost neurons due to injury. The results of the prenatal study suggest that this may indeed have been the case, as both the MFC and PPC lesion rats showed not only enhanced behavioral functional recovery, but also displayed anatomical changes that are correlated with recovery.

5.1 Principal Findings

These experiments both reiterated the findings of previous studies, as well as generating some significantly new findings. First, neurotrophic factors, such as FGF-2, are instrumental in enhancing functional recovery and mediating anatomical changes

following cortical injury. Second, the location of the cortical injury is an important factor in the degree of functional recovery and brain plasticity attained. Third, the developmental stage of the cortex at the time of treatment delivery is a substantial determinant of both recovery and plasticity. Fourth, there is a differential effect of FGF-2 treatment on the lesioned and intact brain. Each of these findings will be discussed in turn.

5.1.1. FGF-2 enhances functional recovery and stimulates anatomical changes

Experientially induced changes in the brain that include morphological changes in neuronal populations are associated with behavioral changes as well (Kolb, 1999; Kolb & Gibb, 1991; Kolb, Holmes & Whishaw, 1987; Lendvai, Stern, Chen & Svoboda, 2000; Mattson & Scheff, 1994). One proposed mechanism by which these changes are induced is through neurotrophic mediated plasticity (Kolb, Witt-Lajeunesse & Gibb, 2001; Lendvai *et al.*, 2000; Schinder & Poo, 2000). FGF-2 has been implicated not only in mitotic processes, but also in synaptic plasticity, neurite outgrowth and neovascularization of the cortex (Abe & Saito, 2001; Bieger & Unsicker, 1996; Cuevas, Giminez-Gallego, Carceller, Cuevas & Crespo, 1993). These same processes are believed to be activated in the brain's response to injury and mediate the degree of functional recovery obtained (Kolb, 1995; 2003). By increasing endogenous levels of FGF-2 prior to and following early cortical injury, anatomical changes occur that improve behavioral functional outcome.

Both anatomical and behavioral changes induced by post-injury treatment are dependent on the mixing protocol of FGF-2 received. A possible change in biological

activity of exogenous FGF-2 in Experiment 1 may explain the very modest improvements in the water task in rats with MFC lesions, as well as why the treatment appeared to be detrimental to performance in the PPC lesion rats. Further, there was an actual decrease in skilled reaching for both the MFC and PPC lesion rats, although PPC lesions do not typically produce a deficit in this task. The behavior of control animals was not significantly changed by the addition of exogenous FGF-2 but there was a slight improvement in acquisition of the water task. That FGF-2 had either no impact or a negative impact on behavioral functioning in lesion rats was correlated with a lack of anatomical changes known to mediate recovery.

Rats that received the fresh-mixed FGF-2 following P3 MFC or PPC lesions showed improved performance of both lesion groups in the water task. As well, treated MFC-lesion rats showed an improvement in reaching skill. There was a similar effect on control rats, as they showed a marked improvement in the water task, although not in reaching. A puzzling finding was that only modest anatomical changes occurred even with the substantial improvements in functional recovery of MFC lesion rats. Furthermore, anatomical changes in controls was opposite of what might be expected in enhanced behavioral functioning. Postnatal FGF-2 did not increase brain weight in lesion rats and, in fact, caused a further decrease than what was observed in untreated lesion animals. A similar effect was found in control males, but not females. Whereas FGF-2 decreased brain weight in control males, it increased the brain weight of female controls such that there was no longer a sex difference in brain weight. The effect of brain weight was mirrored in other anatomical measures as well, with FGF-2 having little or no impact

on cortical thickness, lesion size, cortical surface area or anterior and posterior thalamic measures.

A likely explanation for the lack of anatomical correlates following postnatal FGF-2 is that the measurements were not sensitive to morphological changes that were occurring. There is an assumption that increases in dendritic branching and spine density will translate into increases in brain weight and cortical thickness as well. Both of these morphological changes have been consistently shown to be anatomical correlates of functional recovery in both neonates and adults (Kolb, 1999; Kolb *et al.*, 2001). It may be that these changes were subtle in the present studies and thus did not show in the gross measurements used.

Prenatal FGF-2 appeared to have a greater influence on functional recovery following P3 lesions of either the MFC or the PPC, yet control rats showed little change with the treatment. Both MFC and PPC rats showed a substantial improvement in performance on the water task, although the PPC rats remained impaired relative to control rats. Furthermore, postnatally treated and, to a lesser extent, prenatally treated MFC rats showed improvement in skilled reaching. Yet, unlike the postnatally treated lesion animals, prenatally treated lesion animals showed considerable anatomical changes that correlated with the improvement in behavioral recovery. There was an increase in brain weight in both lesion groups, with the exception of the MFC males. The cortical surface area was also increased in PreFGF-treated MFC rats even though there was no difference found in the lesion size itself. As well, PreFGF reduced the thinning of the cortical mantle in MFC rats, and to a lesser extent in the PPC lesion animals. There was

also a reduction in shrinkage of the posterior thalamus in MFC rats that is thought to be related to deficits in skilled reaching.

Although treatment effects of pre and postnatal FGF-2 on behavior showed an improvement, it was also evident that these effects varied, as did the anatomical correlates. The mechanisms of action of FGF-2 are as yet unknown, which makes the variations in functional and anatomical outcome difficult to explain. One conclusion that can be drawn from these results is related to the possible concentration levels needed to induce functional recovery. It would appear from the varying levels of behavioral changes found between the first and second experiment, that a specific level of biologically active FGF-2 may be required for cortical synaptic plasticity. Related findings have shown that the role that FGF-2 plays is determined, in part, by the levels of FGF-2 available (Qian, Davis, Goderie & Temple, 1997; Ray, Peterson, Schinstine & Gage, 1993; Riva & Mochetti, 1991). Thus, the possibly inconsistent concentration used in the first experiment may actually support the notion that a decreased level of endogenous FGF-2 is related to the poor functional outcome typically found after P3 lesions of either the MFC or PPC in rats.

For reasons outlined in Experiment 1 and exemplified by Appendix 1, caution must be used in comparing the behavioral outcome of rats in Experiment 1 and Experiment 2, however. Furthermore, Rowntree and Kolb (1997) found anatomical correlates of behavioral recovery, using Golgi analysis of cell morphology, in adults with treatment of FGF-2 that was delivered in a similar fashion as that in Experiment 1 of the current set of studies and similar results were found in an unpublished study by A. Witt-

Lajeunesse, G. Gorny, and B. Kolb. Therefore, it may be that the gross anatomical measures in the current experiment were not sensitive to these changes.

5.1.2. The regional location of cortical injury has an impact of treatment responsiveness

Lesions of the MFC at P3 typically produce a dismal functional outcome compared to lesions at a later development stage, although the deficits are comparable to that found after adult brain injury (Kolb, Gibb & Gorny, 2000; Kolb, Petrie & Cioe, 1996). This effect is even more profound following PPC lesions, with P3 lesions producing greater deficits at this age than at either a later developmental stage or in adulthood (Kolb *et al.*, 1987). The results of the present set of experiments also implied a differential effect of not only recovery following early lesions but also in the response to treatment. In all the experiments MFC lesion rats showed a higher level of functional recovery and anatomical correlates than was found in the PPC lesion rats.

Explanations for the differential effect of lesions alone may provide a basis for the differential effect of treatment as well. It has been suggested that the MFC may benefit from its location when there is a demand for increased measures of plasticity placed on the brain, such as in the case of injury. In adult rats, neurogenesis occurs in both the dentate subgranular zone and in the rostral migratory stream (RMS) in response to focal lesions (Jin, Minami, Lan, Mao, Bateur, Simon & Greenberg, 2001). The close proximity to the SVZ which constantly supplies undifferentiated cells to the RMS may allow the MFC to reroute these neurons as replacement cells in response to injury (Kolb & Gibb, 1993). The results of the measurements of the lesion SA in the current set of

experiments imply that the increased functional recovery shown in treated MFC lesion rats was not due to the rescue of compromised neurons in and around the penumbra as had been suggested after injury (Kawamata, Spelioles & Finklestein, 1997; Mocchetti & Wrathall, 1995). Therefore, it may be that location and not any specific characteristic of the MFC lends itself to the influence of treatment strategies. If neurogenesis is increased in the SVZ as suggested (Emoto, Gonzalez, Walicke, Wado, Simmons, Shimasaki & Baird, 1989; Wagner, Black & Diccico-Bloom, 1999), then the proximity of the MFC to the anterior SVZ may improve accessibility to these precursors in comparison to the more posterior location of the PPC. Although this offers a plausible explanation for some of the differences in treatment effect, it is unlikely a complete one. After all, there were anatomical changes in both areas that also suggested a more direct effect of FGF-2 on the lesion site and areas with extensive connectivity.

Although MFC lesion rats show substantial anatomical and functional recovery in comparison to the PPC lesion rats, motor skills seldom recover to the same extent as cognitive functions. It has been hypothesized that the absence or limited functional recovery of motor skills typically found after MFC lesions at any age is due to a restricted capacity of cortico-spinal connections to reorganize or regenerate new processes, a result that contrasts with the substantial reorganization and regrowth that occurs in cortico-cortical connections. Therefore, because this shrinkage is presumed to be related to lost cortico-spinal projections it was surprising to find a decrease in shrinkage of the posterior thalamus. It may be that the FGF treatment either reduced the loss of cortico-spinal axons, or stimulated growth of new ones, possibly from other cortical regions.

An alternative explanation is related to the increase in cerebellum that was found in lesion rats treated with FGF-2, either prenatally or postnatally. It is possible that the decrease in shrinkage was due to an increase in efferent/afferents projections of the cerebellum. This may possibly explain the increased motor skills in rats with lesions of the MFC as well.

5.1.3. Developmental age at the time of treatment delivery is a determinant of both recovery and plasticity

The present studies have shown that not only does the timing of FGF-2 delivery (pre or postnatal) have an effect on behavioral outcome following bilateral focal cortical lesions, but there is also a substantial difference in the affect on anatomical measures as well. Gross anatomical measures that included brain weight, cortical and cerebellar surface area (SA), cortical thickness, and anterior and posterior thalamic cross-sectional areas, all showed varying degrees of change relative to both the controls and untreated lesion rats that was dependent on the timing of treatment delivery. These findings suggest that FGF-2 may play a different role prenatally in the brain that would support an increase in postnatal plasticity.

Prenatal

Neurogenesis is a time when the brain would be expected to be better able to respond to cortical loss owing to the availability of replacement cells. Yet, neurogenesis may not be the only factor that determines the degree of plasticity during embryonic cortical development. Norepinephrine (NE), Serotonin (5-HT), and Dopamine (DA) innervate the cortex between E16 -17 and Achetylcholine (Ach) innervation first occurs

at about E19. Each of these neuromodulators is involved in different aspects of development. NE is involved in tasks that require attention, 5-HT is involved in synaptogenesis and thalamocortical connectivity, DA has an affect on dendritic length and branching, and Ach is involved in learning. Therefore, it is likely that insult to the prenatal brain at different times would likely disrupt one or more of the innervations of neuromodulators that are involved in the establishment of cortical circuitry (Berger-Sweeny & Hohmann, 1997).

Neuronal number has been shown to have little effect on behavioral outcome (Berger-Sweeny & Hohmann, 1997; Kolb & Whishaw, 1989) in either humans or rats. Rather, it is the organization of connections rather than the number of neurons that is critical in supporting functional recovery after injury. Even so, it would seem advantageous to have an abundance of functional neurons prior to injury as it has been shown that there are limitations to the extent of plasticity that may occur with reorganization of intrinsic wiring. I am unaware of any existing research that directly examines possible behavioral benefits of increased neuronal populations, other than the current experiment. This is clearly a place for future studies.

Postnatal

It has been suggested that once migration is complete there is more resiliency to some effects of lesions (Kolb *et al.*, 1987). Following Hebb's proposal that connections may be more important during development than later (Hebb, 1949), it is assumed that once the connections are made, compensation occurs through the reorganization of remaining cells (Kolb & Whishaw, 1989). Support for this notion is found in early studies

of irradiation that showed that cells most sensitive to damage were those that had just become post-mitotic and were about to begin differentiation (Hicks & D'amato, 1961).

The increase in cerebellar size in lesion rats, but not in controls, following prenatal and postnatal exogenous FGF-2 is puzzling as cerebellar size has not been shown to be affected by cortical lesions of either the MFC or the PPC. The only explanation that can be offered at this point is that anomalous cerebellar efferent connections occurred at synaptic sites made available by the cortical lesion (Catro, 1990).

5.1.4. A differential treatment effect exists between the lesioned and intact brain

In the current study it was found that both pre and postnatal treatment with FGF-2 impacted on not only the lesion brain but also on the intact brain. An interesting phenomenon was that the effects of this protein were not the same in the lesion and control rats. A possible explanation may be related to the varying functions of FGF-2 in the developing brain. Riva et al., (1991) has shown that variations in the level of endogenous FGF-2 are linked to developmental events and likely a contributing factor in either the inhibition or initiation of cortical genesis. For example, Engele et al., (1992) showed that lower levels of FGF-2 induced gliogenesis whereas at times of higher levels there appeared to be a inhibition of glia proliferation. As well, Riva et al., (1991) showed that changes in regional levels of FGF-2 coincided with the initiation or completion of peak neurogenesis activity in that particular region. Wagner et al.,(1999) has also shown that neuronal response varies with the concentration of FGF-2 with high levels coinciding with cell proliferation and lower levels with neuronal differentiation. Finally, Kirschner et al., (1995), found a dose-dependent response to neuroprotection effects of FGF-2 after

brain injury. These findings imply that FGF-2 acts as a regulatory mechanism within the CNS. Thus the application of exogenous FGF-2 at a time when it is not required for 'normal' developmental processes may either result in an inhibition of developmental events at that time or initiate an event out of sequence, causing various abnormalities in the brain.

Prenatally, FGF-2 may also have an indirect effect on the environment. The innervation of neuromodulators at specific stages of development may be affected by changes in environment in the intact brain such that anomalous connections are created. This notion is supported by a study of epidermal growth factor (EGF), also implicated in genesis of new cells, in which synaptic change in the cortex of rats that were housed in an enriched environment was blocked by administration of EGF (B. Kolb, J. Cioe, B. Pederson, et al., unpublished data). An explanation offered by Kolb (2003) was that there is a differential effect of neurotrophic factors on new cell generation and existing cells of the neocortex. Thus, the increased levels of FGF-2 induced by exogenous application of the growth factor may have been detrimental to some aspects of synaptic plasticity of the intact brain.

5.1.5. Mechanisms of prenatal FGF-2 mediated functional and anatomical results

The long-term impact of increased neuronal numbers within the cortex is far reaching. It might be expected that such an increase in overall number of cortical neurons might result in a decrease in synapse density per neuron. Thus, the total number of synapses would be increased but the number per neuron would be lower. This possibility leads to a line of questioning not considered yet in this study. For example, there is the

general notion that an increase of neurons may also increase the potential for plasticity in the aging brain. Although changes in spine density and dendritic branching are correlated with experience, there also appears to be limitations as to not only the number of spines that can exist on a given aperture, but also the degree of plasticity available to a single neuron. Consider the normal process of maturation and aging. As the mammalian brain matures there is a steady loss of neurons that induces changes in cell morphology of remaining neurons, such that the surviving cells become more complex as they reorganize and assume the synaptic connections of lost neurons. Thus, the consistent cell loss that exists is only evident in behavioral functioning when the neuronal losses become too extensive for existing neurons to compensate, the consequence of which is age-related dementia. Therefore, an initial increase in cell numbers may be beneficial in 'slowing' consequences of age-related cell loss.

A related notion is that an increase in the number of functioning cortical neurons may benefit the continued functional recovery in patients whom have suffered a brain injury or insult. As stated, there are consequences of demands that are put on the brain and in the case of injury the brain has expended much of its available plasticity to compensate for the injury. Thus, even after functional recovery has reached an optimal level there is often a reappearance of some of the initial behavioral deficits due to the new demands put on the brain during the aging processes. It would seem reasonable to consider that an increase in neuronal numbers may have a positive impact by diminishing the demands on the brain and prolonging the benefits of the compensatory mechanisms that were utilized in the recovery attained.

Finally, the benefits of such a potential increase in plasticity may be extended to include preventive treatment strategies for neurodegenerative diseases. Although certainly not a cure, it is possible that symptoms may be delayed by using preventive measures that could be initiated in cases where inheritability of such a disorder is likely.

5.1.6. Future Directions

The possibilities of treatment strategies that arise from the findings are exciting. Prior to the development of such strategies, however, there is a need for clarification of some of the results, as well as the need to determine the mechanisms by which FGF-2 is influencing recovery. Future research that would help to accomplish these goals include: 1) An extension of the studies in Appendix 2 would be beneficial in that it would allow a quantification of neurons. 2) A related study in which FGF-2 was blocked during peak cortical neurogenesis would also be beneficial in ascertaining the extent of FGF-2 requirement for normal cortical development. 3) A replication of the Experiment 2 and 3 with the inclusion of Golgi and electron microscopy (EM) would aid in the clarification of the extent of anatomical changes that occurred following the increase of endogenous FGF-2 both prenatally and postnatally. 4) Finally, an aging study that examined the long-term benefits of an initial increase of cortical neurons, as shown in the prenatal FGF-2 experiment, would be a useful addition when contemplating the development of treatment strategies.

Conclusion

The majority of anatomical irregularities that are correlated with behavioral deficits following injury to the MFC or PPC are related to an overall loss of neurons that

are not restricted to the lesion site. The loss is exemplified by cortical measurements that show a decrease in brain weight, a thinning of the cortical mantle, and a reduced cortical surface area. As well, there was a loss of cortical and subcortical connectivity that is believed to underlie the thalamic shrinkage that is typically found in these cases. Subcutaneous delivery of exogenous FGF-2, either prenatally or postnatally, induced anatomical changes that are correlated with functional recovery. In rats that received FGF-2 treatment, the functional benefits include an improved performance on cognitive task such as the Morris water task, and to a lesser extent motor skills as shown in increases in reaching success. The anatomical changes and the level of recovery achieved, however, are regionally dependent and perhaps also dependent on the level of FGF-2 administered.

- Abe, K. & Saito, H. (2001) Effects of basic fibroblast growth factor on central nervous system functions. *Pharmacological Research*, **43**, 307-312.
- Altman, J. & Bayer, S.A. (1984) The development of the rat spinal cord *Advances in Anatomy, Embryology and Cell Biology*. Springer, New York.
- Baird, A. (1994) Fibroblast growth factors: Activities and significance of non-neurotrophin neurotrophic growth factors. *Current Opinion in Neurobiology*, **4**, 78-86.
- Bayer, S.A. & Altman, J. (1991) *Neocortical Development*. Raven Press, New York.
- Berger-Sweeny, J. & Hohmann, C.F. (1997) Behavioral consequences of abnormal cortical development: Insights into developmental disabilities. *Behavioural Brain Research*, **86**, 121-142.
- Biebl, M., Cooper, C.M., Winkler, J. & Kuhn, H.G. (2000) Analysis of neurogenesis and programmed cell death reveals a self-renewing capacity in the adult rat brain. *Neuroscience Letters*, **291**, 17-20.
- Bieger, S. & Unsicker, K. (1996) Functions of fibroblast growth factors (FGFs) in the nervous system. In C. Bell (ed.) *Chemical Factors in Neural Growth, Degeneration and Repair*. Elsevier, New York, pp. 339-375.
- Caday, C.G., Klagsbrun, M., Fanning, P.J., Mirzabegian, A. & Finklestein, S.P. (1990) Fibroblast growth factor (FGF) levels in the developing rat brain. *Developmental Brain Research*, **52**, 241-246.
- Calton, J.L., Dickson, A.R., & Snyder, L. H. (2002). Non-spatial, motor specific activation in posterior parietal cortex. *Nature Neuroscience*, **5**, 580 -588.

- Cameron, H.A., Hazel, T.G. & McKay, R.D. (1998) Regulation of neurogenesis by growth factors and neurotransmitters. *Journal of Neurobiology*, **36**, 287-306.
- Catro, A.J. (1990) Plasticity in the motor system. In T. R. C. Kolb B. (ed.) *The Cerebral Cortex of the Rat*. MIT Press, Cambridge (MA), pp. 563-588.
- Chadi, G. & Fuxe, K. (1998) Analysis of trophic responses in lesioned brain: Focus on basic fibroblast growth factor mechanisms. *Brazilian Journal of Medical and Biological Research*, **31**, 231-241.
- Chapman, H., Gavrilesco, M., Wang, H., Kean, M., Egan, G. & Castiello, U. (2002) Posterior parietal control of reach-to-grasp movements in humans. *European Journal of Neuroscience*, **15**, 2037-2042.
- Cuevas, P., Gimenez-Gallego, G., Carceller, F., Cuevas, B. & Crespo, A. (1993) Single topical application of human recombinant basic fibroblast growth factor (rbFGF) promotes neovascularization in rat cerebral cortex. *Surg. Neurol.*, **39**, 380-384.
- Doetsch, F., Gardia-Verdugo, J.M. & Alvarez-Buylla, A. (1997) Cellular composition and three-dimensional organization of the subventricular germinal zone in the adult mammalian brain. *Journal of Neuroscience*, **17**, 5046-5061.
- Emoto, N., Gonzalez, A.M., Walicke, P.A., Wado, E., Simmons, D.M., Shimasaki, S. & Baird, A. (1989) Basic fibroblast growth factor (FGF) in the central nervous system: Identification of specific loci of basic FGF expression in the rat brain. *Growth Factors*, **2**, 21-29.
- Engle, J. & Bohn, M.C. (1992) Effects of acidic and basic fibroblast growth factors (aFGF, bFGF) on glial precursor cell proliferation: Age dependency and brain region specificity. *Developmental Biology*, **152**, 363-372.

- Erickson, P.S., Perfilieva, E., Bjork-Erickson, T., Alborn, A.M., Nordborg, C., Peterson, D.A. & Gage, F.H. (1998) Neurogenesis in the adult human hippocampus. *Nat Med*, **4**, 1313-1317.
- Ferhat, L., Khretchatsky, M., Roisin, M.P. & Barbin, G. (1993) Basic fibroblast growth factor-induced increase in zif/268 and c-fos mRNA levels is Ca²⁺ dependent in primary cultures of hippocampal neurons. *Journal of Neurochemistry*, **61**, 1105-1112.
- Ghosh, A. & Greenberg, M.E. (1995) Distinct roles for bFGF and NT-3 in the regulation of cortical neurogenesis. *Neuron*, **15**, 89-103.
- Gibb, R., Kolb, B. (2000) Comparison of the effects of pre- and postnatal tactile stimulation in functional recovery following early frontal cortex lesions. Society for Neuroscience Abstracts: 366.369.
- Gibb, R., Burton, T., Day, M., Kolb, B. (2002) Protein changes associated with cortical lesions during development. Society for Neuroscience Abstracts: 534.538.
- Gomez-Pinilla, F. & Cotman, C.W. (1992) Transient lesion-induced increase in basic fibroblast growth factor and its receptor in layer VIb (Subplate cells) of the adult rat cerebral cortex. *Neuroscience*, **49**, 771-780.
- Gomez-Pinilla, F., Lee, J.W.K. & Cotman, C.W. (1994) Distribution of basic fibroblast growth factor in the developing rat brain. *Neuroscience*, **61**, 911-923.
- Gospodarowicz, D. (1990) Fibroblast growth factor and its involvement in developmental process. *Current Topics in Developmental Biology*, **24**, 57-93.
- Gospodarowicz, D., Neufeld, G. & Schweiger, L. (1986) Fibroblast growth factor. *Mol. Cell Endocrin.*, **46**, 187-204.

- Gould, E., Reeves, A.J., Graziano, M.S.A. & Gross, C.G. (1999) Neurogenesis in the neocortex of adult primates. *Science*, **286**, 548-552.
- Hebb, D. O. (1949) *The Organization of Behavior*. Wiley, New York.
- Hicks, S.P. & D'Amato, C.J. (1961) How to design and build abnormal brains using radiation during development. In W. S. D. Fields, M. M. (ed.) *Disorders of the Developing Nervous System*. Thomas, Springfield, pp. 60-97.
- Hicks, S.P. & D'Amato, C.J. (1978) Effects of ionizing radiation on developing brain and behavior. *Studies on the Development of Behavior and the Nervous System*. Academic Press Inc., New York.
- Jin, K., Nunani, M., Lan, J. Q., Mao, X. O., Batteur, S., Simon, R. P., & Greenberg, D.A. (2001) Neurogenesis in dentate subgranular zone and rostral subventricular zone after focal cerebral ischemia in the rat. *Proc. Natl. Acad. Sci. USA*, **98**, 4710-4715.
- Kawamata, T., Spelioles, E.K. & Finklestein, S.P. (1997) The role of polypeptide growth factors in recovery from stroke. In B. A. S. H.J. Freund, and O. W. Witte (ed.) *Brain Plasticity, Advances in Neurology*. Lippincott-Raven Publishers, Philadelphia.
- Kennard, M.A. (1936) Age and other factors in motor recovery from precentral lesion in monkeys. *American Journal of Physiology*, **115**, 138-146.
- King, V.R. & Corwin, J.V. (1992) Spatial deficits and hemispheric asymmetries in the rat following unilateral and bilateral lesions of posterior parietal or medial agranular cortex. *Behavioural Brain Research*, **50**, 53 - 68.

- Kirschenbaum, B., Doetsch, F., Lois, C. & Alvarez-Buylla, A. (1999) Adult subventricular zone neuronal precursors continue to proliferate and migrate in the absence of the olfactory bulb. *Journal of Neuroscience*, **19**, 2171-2180.
- Kirschner, P.B., Henshaw, R., Weise, J., Trubetskoy, V., Finklestein, S., Schultz, J.B. & Beal, M.F. (1995) Basic fibroblast growth factor protects against excitotoxicity and chemical hypoxia in both neonatal and adult rats. *Journal of Cerebral Blood Flow and Metabolism*, **15**, 619-623.
- Koketsu, N., Berlove, D.J., Moskowitz, M.A., Kowall, N.W., Caday, C.G. & Finklestein, S.P. (1994) Pretreatment with intraventricular basic fibroblast growth factor (bFGF) decreases infarct size following focal cerebral ischemia in rats. *Annals in Neurology*, **35**, 451-457.
- Kolb, B. (1984) Functions of the frontal cortex of the rat: A comparative review. *Brain Research Reviews*, **8**, 65-98.
- Kolb, B. (1995) *Brain Plasticity and Behavior*. Lawrence Erlbaum Associates, Mahwah.
- Kolb, B. (1999) Towards an ecology of cortical organization: Experience and the changing brain. In J. Grafman, Y. Christen (eds.) *Neuronal Plasticity: Building a Bridge from the Laboratory to the Clinic*. Springer-Verlag, New York, pp. 17-34.
- Kolb, B. (2003) Overview of cortical plasticity and recovery from brain injury. *Physical Medicine and Rehabilitation Clinics of North America*, **14**, S7-S25.
- Kolb, B., Buhrmann, K., McDonald, R. & Sutherland, R.J. (1994) Dissociation of the medial prefrontal, posterior parietal, and posterior temporal cortex for spatial navigation and recognition memory in the rat. *Cerebral Cortex*, **6**, 664-680.

- Kolb, B. & Cioe, J. (1998) Absence of recovery or dendritic reorganization after neonatal posterior parietal lesions. *Psychobiology*, **26**, 134-142.
- Kolb, B., Cioe, J. & Muirhead, D. (1998) Cerebral morphology and functional sparing after prenatal frontal cortex lesions in rats. *Behavioural Brain Research*, **91**, 143-155.
- Kolb, B. & Elliot, W. (1987) Recovery from early cortical damage in rats. II. Effects of experience on anatomy and behavior following frontal lesions at 1 or 5 days of age. *Behavioral Brain Research*, **26**, 47-56.
- Kolb, B. & Gibb, R. (1991) Sparing of function after neonatal frontal lesions correlates with increased cortical dendritic branching: A possible mechanism for the Kennard effect. *Behavioral Brain Research*, **43**, 51-56.
- Kolb, B. & Gibb, R. (1993) Possible anatomical basis of recovery of function after neonatal frontal lesions in rats. *Behavioral Neuroscience*, **107**, 799-811.
- Kolb, B. & Gibb, R. (2001) Early brain injury, plasticity, and behavior. In C. A. Nelson, M. Luciana (eds.) *Handbook of Developmental Cognitive Neuroscience*. The MIT Press, Cambridge, pp. 175-190.
- Kolb, B., Gibb, R. & Gorny, G. (2000) Cortical plasticity and the development of behavior after early frontal cortical injury. *Developmental Neuropsychology*, **18**, 423-444.
- Kolb, B., Gibb, R., Gorny, G. & Wishaw, I.Q. (1998) Possible regeneration of rat medial frontal cortex following neonatal frontal lesions. *Behavioural Brain Research*, **91**, 127-141.

- Kolb, B., Holmes, C. & Wishaw, I.Q. (1987) Recovery from early cortical lesions in rats. III. Neonatal removal of posterior parietal cortex has greater behavioral and anatomical effects than similar removals in adulthood. *Behavioural Brain Research*, **26**, 119-137.
- Kolb, B., Nonneman, A.J. & Singh, R.K. (1974) Double dissociation of spatial impairments and perseveration following selective prefrontal regions in rats. *Journal of Comparative Physiol Psychol*, **87**, 772-780.
- Kolb, B., Petrie, B., & Cioe, J. (1996) Recovery from early cortical damage in rats, VII. Compensation of the behavioural and anatomical effects of medial prefrontal lesions at different ages of neural maturation. *Behavioural Brain Research*, **79**, 1-13.
- Kolb, B., Sutherland, R.J. & Wishaw, I.Q. (1983) A comparison of the contributions of the frontal and parietal association cortex to spatial localization in rats. *Behavioral Neuroscience*, **97**, 13-27.
- Kolb, B. & Tees, R.C. (1990) *The Cerebral Cortex of the Rat*. The MIT Press, Cambridge.
- Kolb, B. & Walkey, J. (1987) Behavioural and anatomical studies of the posterior parietal cortex in the rat. *Behavioural Brain Research*, **23**, 127 - 145.
- Kolb, B. & Wishaw, I.Q. (1981) Neonatal frontal lesions in the rat: Spraying of learned but not species-typical behavior in the presence of reduced brain weight and cortical thickness. *Journal of Comparative Physiological Psychology*, **95**, 863-879.

- Kolb, B. & Whishaw, I.Q. (1985) Earlier is not always better: Behavioral dysfunction and abnormal morphogenesis following neonatal cortical lesions in the rat. *Behavioral Brain Research*, **17**, 25 - 43.
- Kolb, B. & Whishaw, I.Q. (1989) Brain development, plasticity, and behavior. *American Psychologist*, **44**, 1203-1212.
- Kolb, B. & Whishaw, I.Q. (1990) *Fundamentals of Human Neuropsychology*. Freeman, New York.
- Kolb, B. & Whishaw, I.Q. (1998a) Brain plasticity and behavior. *Annual Review of Psychology*, **49**, 43-64.
- Kolb, B. & Whishaw, I.Q. (1998b) Synaptic plasticity and the organization of behaviour after early and late brain injury. *Annual Review of Psychology*.
- Kolb, B., Brown, R., Witt-Lajeunesse, A. & Gibb, R. (2001) Neural compensation after lesion of the cerebral cortex. *Neural Plasticity*, **8**, 1-15.
- Kuhn, H.G., Palmer, T.D. & Fuchs, E. (2001) Adult neurogenesis: A compensatory mechanism for neuronal damage. *Eur. Arch. Psychiatry Clin. Neurosci.*, **251**, 152-158.
- Lendvai, B., Stern, E.A., Chen, B. & Svoboda, K. (2000) Experience-dependent plasticity of dendritic spines in the developing rat barrel cortex in vivo. *Nature*, **404**, 876-881.
- Lin, D.A. & Finklestein, S.P. (1997) Basic fibroblast growth factor: A treatment for stroke. *The Neuroscientist*, **3**, 247-250.

- Liu, H.M. & Chen, H.H. (1994) Correlation between fibroblast growth factor expression and cell proliferation in experimental brain infarct: Studied with proliferating cell nuclear antigen immunohistochemistry. *Journal of Neuropathology and Experimental Neurology*, **53**, 118-126.
- Magavi, S.S., Leavitt, B.R. & Macklis, J.D. (2000) Induction of neurogenesis in the neocortex of adult mice. *Nature*, **405**, 951-955.
- Mattson, M.P. & Cheng, B. (1993) Growth factors protect neurons against excitotoxic / ischemic damage by stabilizing calcium homeostasis. *Stroke*, **24**, 136-140.
- Mattson, M. P., & Scheff, S. W. (1994a) Endogenous neuroprotection factors and traumatic brain injury: Mechanisms of action and implications for therapy. *Journal of Neurotrauma*, **11**, 3-33.
- Miller, M. W. (1988) Development of projection and local circuit neurons in neocortex. In A. Peters & E. G. Jones (eds). *Cerebral Cortex: Vol. 7. Development and Maturation of Cerebral Cortex*. Plenum Press, New York, pp.133-166.
- Mocchetti, I. & Wrathall, J.R. (1995) Neurotrophic factors in central nervous system trauma. *Journal of Neurotrauma*, **12**, 853-869.
- Prats, H., Kaghad, M., Prats, A.C., Klagsbrun, M., Lelias, F.A., Smith, J.A. & Caput, D. (1989) High molecular mass forms of basic fibroblast growth factor are initiated by alternative CUG codons. *Proc. Natl. Acad. Sci. USA*, **86**, 1836-1840.
- Qian, X., Davis, A.A., Goderie, S.K. & Temple, S. (1997) FGF2 concentration regulates the generation of neurons and glia from multipotent cortical stem cells. *Neuron*, **18**, 81-93.

- Ray, J., Peterson, D.A., Schinstine, M. & Gage, F.H. (1993) Proliferation, differentiation, and long-term culture of primary hippocampal neurons. *Proc. Natl. Acad. Sci. USA*, **90**, 3602-3606.
- Reid, C.B. & Walsh, C.A. (1996) Early development of the cerebral cortex. In R. R. Mize, & Erzurumlu, R. S. (ed.) *Neural Development and Plasticity*. Elsevier, New York, pp. 17-30.
- Reilly, J.F. & Kumari, V.G. (1996) Alterations in fibroblast growth factor receptor expression following brain injury. *Experimental Neurology*, **140**, 139-150.
- Riva, M.A. & Mocchetti, I. (1991) Developmental expression of basic fibroblast growth factor gene in rat brain. *Developmental Brain Research*, **62**, 45-50.
- Rowntree, S. & Kolb, B. (1997). Blockade of basic fibroblast growth factor retards recovery from motor cortex injury in rats. *European Journal of Neuroscience*, **9**, 2432-2442.
- Schinder, A.F. & Poo, M. (2000) The neurotrophin hypothesis for synaptic plasticity. *TINS*, **23**, 639-645.
- Sharp, F.R., Liu, J. & Bernabeu, R. (2002) Neurogenesis following brain ischemia. *Developmental Brain Research*, **134**, 23-30.
- Spear, P.D. (1996) Neural plasticity after brain damage. In R. R. Mize, & Erzurumlu, R. S. (ed.) *Neural Development and Plasticity*. Elsevier, New York, pp. 391-408.
- Sutherland, R.J. (1985) The navigating hippocampus: and individual medley of space, memory, and movement. In V. Bujzski G., C. H. (ed.) *Electrical Activity of the Archicortex*. Hungarian Academy of Science, Budapest, pp. 255-280.

- Takahashi, T., Nowakowski, R.S. & Caviness Jr., V.S. (1994) Mode of cell proliferation in the developing mouse neocortex. *Proc. Natl. Acad. Sci. USA*, **91**, 375-379.
- Tao Y, Black IB, DiCicco-Bloom E (1997) In vivo neurogenesis is inhibited by neutralizing antibodies to basic fibroblast growth factor. *Journal of Neurobiology*, **33**, 289-296.
- Temple, S. & Alvarez-Buylla, A. (1999) Stem cells in the adult mammalian central nervous system. *Current Opinion in Neurobiology*, **9**, 135-141.
- Uylings, H.B.M., Eden, C.G.V., Parnavelas, J.G. & Kalsbeek, A. (1990) The prenatal and postnatal development of rat cerebral cortex. In R.C. Tees & B. Kolb (eds.) *The Cerebral Cortex of the Rat*. The MIT Press, Cambridge, pp. 35-76.
- Vaccarino, F.M. (1999). Changes in cerebral cortex size are governed by fibroblast growth factor during embryogenesis. *Nature Neuroscience*, **2**, 246-253.
- Wagner, J. P., Black, I. B., & DiCicco-Bloom, E. (1999) Stimulation of neonatal and adult neurogenesis by subcutaneous injections of basic fibroblast growth factor. *Journal of Neuroscience*, **19**, 6006-6016.
- Walicke, P., Cowan, W. M., Ueno, N., Baird, A., & Guillemin, R. (1986). Fibroblast growth factor promotes survival of dissociated hippocampal neurons and enhances neurite extension. *Proc. Nat. Acad. Sci. USA*, **83**, 3012-3016.
- Weiss, S., Dunne, C., Hewson, J., Wohl, C., Wheatley, M., Peterson, A.C. & Reynolds, B.A. (1996) Multipotent CNS stem cells are present in the adult mammalian spinal cord and ventricular neuroaxis. *Journal of Neuroscience*, **16**, 7599-7609.
- Whishaw, I.Q., Pellis, S.M. & Gorny, B.P. (1992) Medial frontal cortex lesions impair the aiming component of rat reaching. *Behavioral Brain Research*, **50**, 93-104.

Whishaw, I.Q. & Tomie, J. (1989) Olfaction directs skilled forelimb reaching in the rat.

Behavioral Brain Research, **32**, 11-21.

Yamada, K., Kinoshita, A., Kohmura, E., Sakaguchi, T., Taguchi, J., Kataoka, K., &

Hayakawa, T. (1991). Basic fibroblast growth factor prevents thalamic

degeneration after cortical infarction. *Journal of Cerebral Blood Flow and*

Metabolism, **11**, 472-478.

6. APPENDIX 1

The Effect of Experimental Parameters used in Experiment 1

A pilot study was conducted to examine the possibility that certain protocols used in Experiment 1 may have had an affect on the performance of rats in the Morris water task. First, in Experiment 1 the time interval between trials had been held constant at 20 minutes. A review of past studies showed that in fact the time between trials was clearly reduced as the animals learned the task. Second, in Experiment 1, a round platform had been used. The absence of edges, in which the rats may bump into, thus learning more quickly the location of the platform may have affected performance. Third, in Experiment 1 the platform had been located on the far end of the pool. Placement of the platform on the end of the pool that was in proximity to holding cages may have aided in acquisition of the task.

To study whether the above protocols were a factor in the poor performance of controls in Experiment 1, the present study consisted of four groups: 1) 20 minute interval (2 M; 2 F), 2) 5 minute interval (2 M; 2 F), 3) square platform (2 M; 2 F), 4) square platform and location (2 M; 2 F). Aside from the conditions placed on each of the above groups, all other protocols were followed as in Experiment 1. Animals were tested in four trials a day, running for 7 consecutive days.

To control for high variance in the 20 minute interval group, latency was square rooted and used for analyses. The results showed that keeping interval time between trials at a consistent 20 minutes had a detrimental effect on performance in the Morris water task (see Figure 2A-2). All groups were comparable on Trial block 1, but by Trail Block

7, apparent group differences were seen. The 20 minute group appeared to have difficulty retaining the platform location from trial to trial, especially the males (see Figure 2A-2).

A Repeated Measures ANOVA showed that there were no differences between groups, $F(3,12) = 1.446$, $p = 0.278$. A Fisher's LSD, however, showed that the 5 minute, the shape, and the location groups performed at comparable levels on Trial block 1 ($p = 0.456$, $p = 0.936$, $p = 0.826$, respectively) relative to the 20 minute group. By Trail block 7, however, all groups performed significantly better at the task relative to the 20 minute group ($p = 0.031$, $p = 0.007$, $p = 0.004$, respectively).

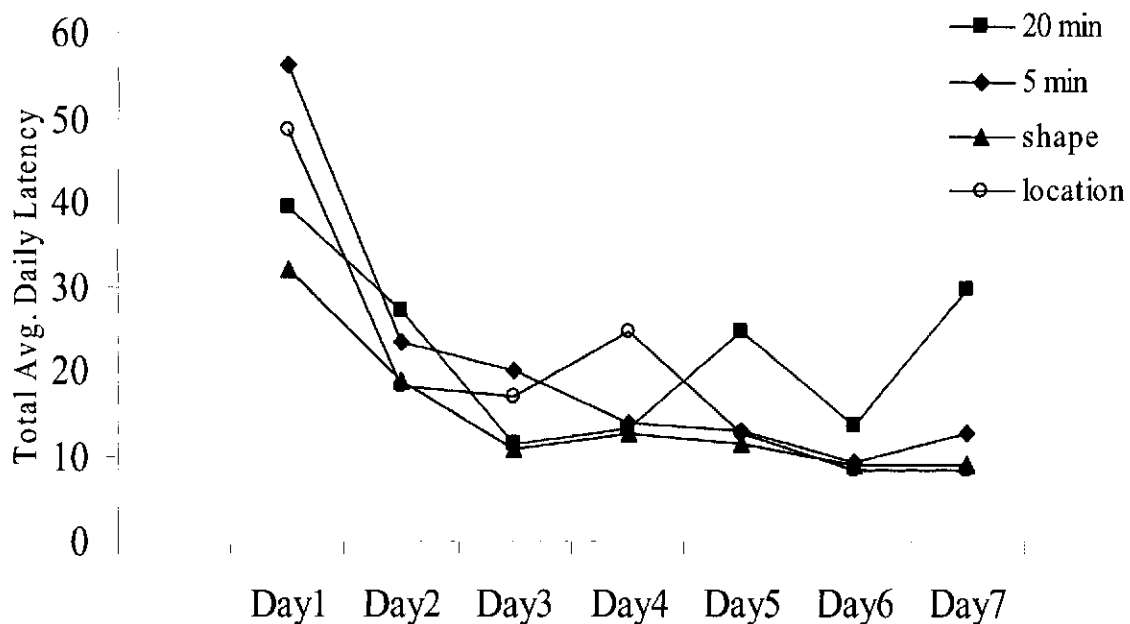

Figure 2A-1. Mean latency to find platform with sex collapsed.

Looking at the sexes separately, males had great difficulty in acquiring the task at 20 minute intervals, relative to both other same-sex groups, and females. As males are more affected by their environment (Shors, 1998), the 20 minute delay between trials may have exasperated their stress level and resulted in a learning deficit.

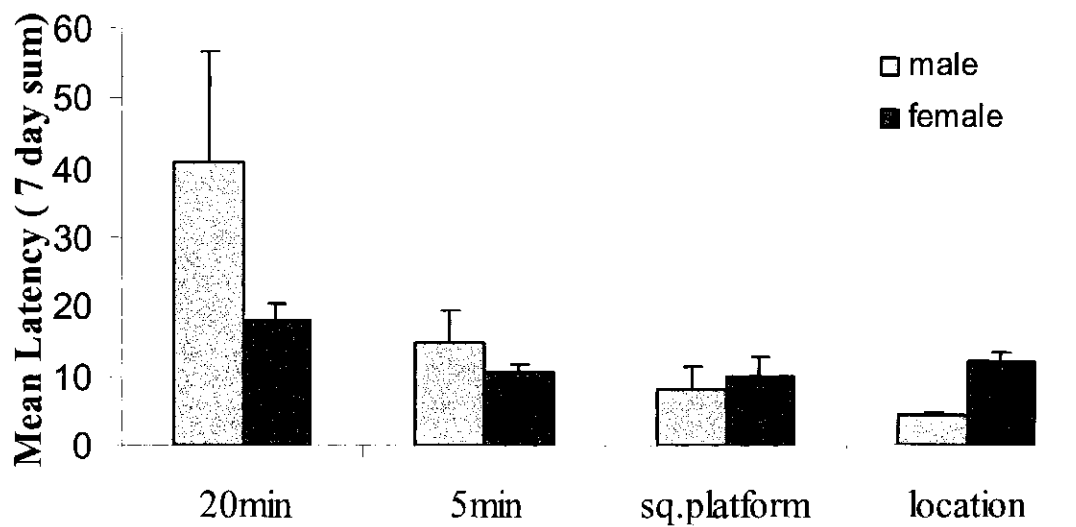

Figure 2A-2 Mean latency to find platform separately for sexes.

Based on these findings, it was determined that the control animals in Experiment 1 may have experienced some difficulty on this task which influenced the results. The effect of these factors on lesion rats was not examined. Therefore, the results of the Morris water task in Experiment 1 must be viewed with reservation as we are unsure if the effect of any, or all, of these factors was equal across groups.

7. APPENDIX 2

The present study was designed to examine whether or not exogenous application of prenatal FGF-2 would visibly increase neuronal numbers as suggested by Vaccarino et al. (1999). In this experiment, both bromodeoxyuridine (BrdU) and FGF-2 were administered prenatally to allow for a visual comparison of neuronal numbers in the cortex. Other than gross anatomical measures, no other analyses were performed. Furthermore, the latter measures must be viewed with caution as each group consisted of one litter and a litter-effect, therefore cannot be ruled out.

7.1. MATERIALS AND METHODS

7.1.1. Subjects

Forty six pups were used for the study. The pups of one dam (N = 14) received prenatal FGF-2 as in Experiment 3.1 and Experiment 3.2, with the addition of prenatal BrdU via IP injections of the dam. The pups from the second dam (N = 16) received only prenatal BrdU via IP injections of the dam. The pups from the third dam (N = 16) were used as controls and received no treatment. All pregnancies went full term without incidence.

The pups were housed with dams in clear plexi-glass hanging tubs with a 12 hr light/dark schedule until they were 28 days old. The pups were sacrificed at P28 and the brains prepared for anatomical analysis.

7.1.2. Prenatal FGF-2

For methods involving the determination of conception day see Experiment 3. As well, the administration of prenatal FGF-2 followed the procedures outlined in Experiments 3.1

and 3.2. A FGF-2 concentration of 10µg bFGF per 1ml BSA was used. A dose of .1 ml/100 gram body weight was administered to each of two injection sites.

7.1.3. Prenatal BrdU

For the FGF-2/BrdU dam, BrdU injections began 24 hours after administration of FGF-2. The second dam received only BrdU. Both pregnant dams were given intraperitoneal (IP) injections of 60mg/kg BrdU in 0.007N NaOH on E16.5. Each dam received three injections that were spaced 3 hours apart. Fewer cells are born at E17, thus there would be fewer progeny from the BrdU labeled cells (Reid & Walsh, 1996).

7.1.4. Anatomical Procedures

At P28 pups were given an overdose of sodium pentobarbital, weighed, and intracardinally perfused with 0.9% phosphate buffered saline (PBS .1M), followed by Lana's fixative (formaldehyde and picric acid). The brains were extracted, the spinal cord trimmed even with the cerebellum and the olfactory bulbs removed. Brains were then weighed, post-fixed in Lana's fixative, and stored in the fridge until being sliced. After a period of fixation, the brains were removed from the solution and the dorsal view photographed with a computer imaging program (NIH Image). As BrdU immunohistochemistry was not performed on the Control NT group, they were excluded from further analysis. The tissue of the remaining subjects was prepared for fluorescent staining.

7.1.5. Immunohistochemistry

Tissue Preparation

Using a Vibratome, the brains were cut at 50 μm in .1M PB. Every section was taken with every 5th section placed into a separate aliquot filled with .1M PB. The sections were then refrigerated until ready to stain. To prepare for staining, sections from the aliquots were removed and samples representing anterior to posterior sections of cortex were incubated in 2 M HCl for 30 minutes at 50° C. The sections were removed from the incubator and washed five times in PB for about five minutes each time.

BrdU & NeuN Fluorescent Staining Protocol (Re: Robbin Gibb)

Day one, the sections were placed into aliquots of Accurate anti-BrdU (1:175), that had been reconstituted and stored at -80° C in aliquots at a concentration of 1 μl /8.75ml, and refrigerated overnight.

On day two, sections were removed from anti-body and washed five times in PB for five minutes each time. sections were incubated overnight at 4° C in Chemicon anti-NeuN (1:1000) that had been reconstituted and stored at 4° C at a concentration of 10 μl /10ml.

On day three, the sections were removed the aliquots and washed five times in PB for about five minutes each time. Sections were incubated overnight at 4° C in Chemicon Goat anti-rat (1:1000) that had been reconstituted and stored at -80° C at a concentration of 10 μl /10ml.

On day four, the sections were removed and washed five times in PB for about five minutes each time. Due to light-sensitivity of the fluorescent stains, the procedures were carried out with the lights in the room turned off and only a dim lamp used for lighting.

Sections were incubated overnight at 4° C in M.P. anti-mouse 488 (1:500) NeuN (1:1000) that had been reconstituted and stored at 4° C at a concentration of 20µ/10ml.

On day five, the sections were removed and washed five times in PB for about five minutes each time. Again, owing to light-sensitivity of the fluorescent stains, the lights in the room were turned off and only a dim lamp was used. Sections were incubated overnight at 4° C in M.P. Streptavidin 546 (1:500) that had been reconstituted and stored at 4° C at a concentration of 20µ/10ml.

On day six the sections were removed and washed twice in PB for about five minutes each time and placed in tap water as they were mounted on 1% gel slides and left to dry overnight.

Finally, on day seven the slides were cover-slipped with anti-fading mountant made up of 70% glycerol, 25% .1M phosphate buffer, and 5% n-propyl-gallate that had been heated in boiling water to dissolve the n-propyl-gallate and cooled before bringing the pH to 7.4. Again, the mounted sections were kept out of the light as much as possible and stored in the fridge.

Tissue Analysis with the Confocal Microscope

Using the confocal microscope, tissue was viewed at 40X magnification and snap shots taken first of the BrdU fluorescent staining (red) and then the NeuN fluorescent staining (green). The two images are then overlaid and cells that are double-stained, that is stained with both the BrdU and NeuN, will be yellow. In the present experiment, because the red cells must have originated on E16.5 –E17 (or be the prodgeny of earlier born cells) and

the green cells are likely to be neurons, then a yellow or double-labeled cell is likely a neuron that was born on or before E17.

7.2. ANATOMICAL RESULTS

Experiment 3.3

7.2.1. Body Weight

Prenatal BrdU appeared to have a negative impact on body that was diminished with the addition of prenatal FGF-2. Pups with BrdU alone were lighter than both the controls and BrdU/FGF pups (see Figure 3.3.1). Yet, BrdU/FGF pups were no different in body weight relative to controls. An ANOVA with treatment and sex as variables showed a significant main effect of sex, $F(1,34) = 17.21, p = 0.000$, and treatment, $F(2,34) = 7.97, p = 0.001$, but no interaction, $F(2,34) = 1.29, p = 0.285$. A LSD test revealed that BrdU and BrdU/FGF pups did not significantly differ from controls ($p = 0.087$ & $p = 0.226$, respectively). A novel finding was that BrdU only pups were significantly lighter than BrdU/FGF pups ($p = .006$).

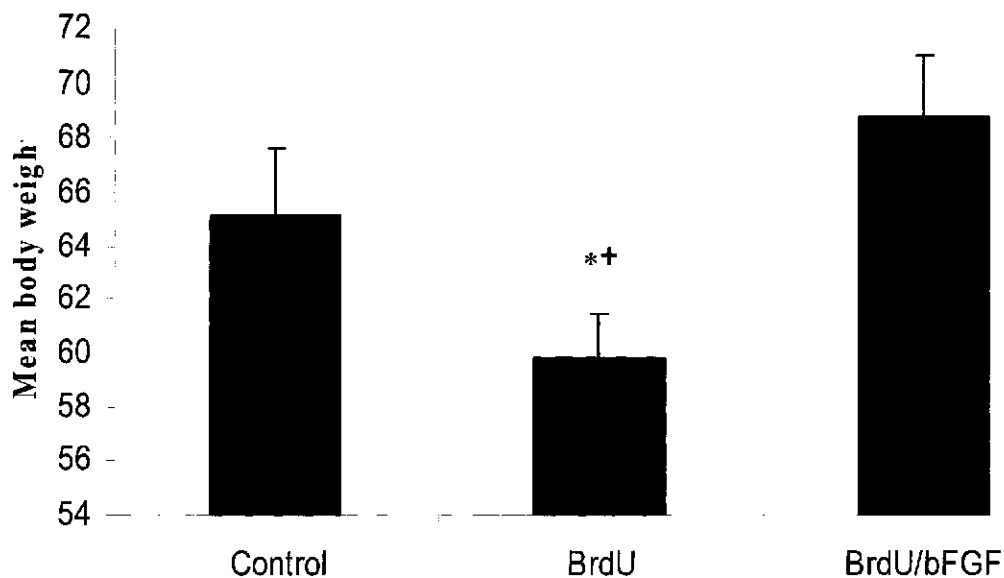

* significantly different from NT Controls at $p \leq 0.001$
† significantly different from BrdU/FGF pups at $p \leq 0.001$

Figure 3.3.1 Mean body weights of each group

7.2.2. Brain Weight

Pups that received BrdU only had lighter brains than pups receiving both BrdU and FGF-2 and controls. BrdU/FGF treated pups did not differ in brain weight relative to controls (see Figure 3.3.2). An ANOVA with sex and treatment as variables showed a main effect of sex, $F(1,40) = 18.50$, $p = .000$, and treatment, $F(2,40) = 9.94$, $p = .000$, but no interaction, $F(2,40) = 0.441$, $p = 0.646$. A LSD revealed a significant difference between brain weights of the BrdU group and Control group ($p = .001$). In contrast, the BrdU/FGF pups did not significantly differ from the controls ($p = .194$), and showed only a marginally significant difference relative to the BrdU pups ($p = .057$).

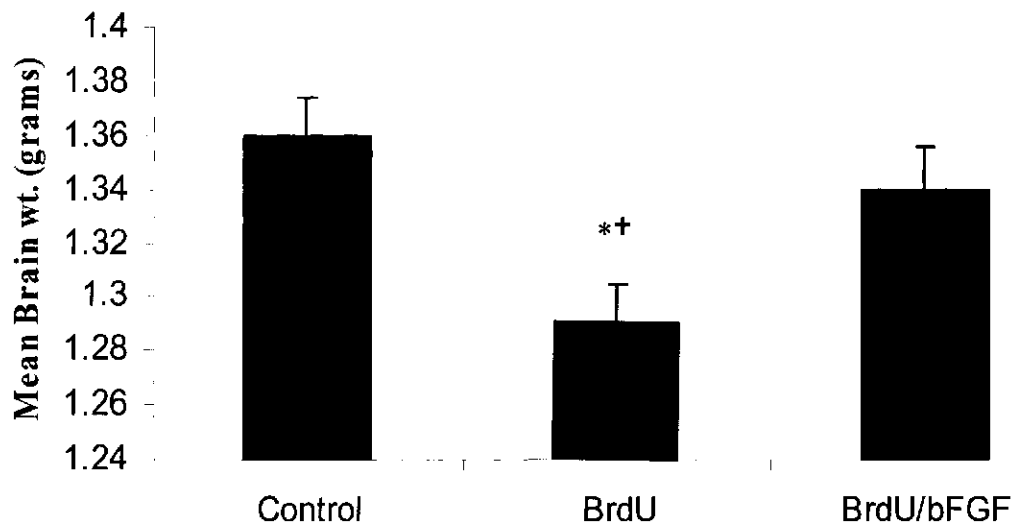

* significantly different from NT Controls at $p \leq 0.001$
† significantly different from BrdU/FGF pups at $p \leq 0.06$

Figure 3.3.2 Mean brain weights for each group

7.3 CONCLUSIONS

The number of cortical neurons that make up the final size of the cortex is determined by the number of progenitor cells, their rate of proliferation, and the number of mitotic cycles they undergo (Vacarino, 1999). Exogenous FGF-2 at two embryonic stages produced differential mitotic influence as E20.5 increased the number of glial cells and E15.5 increased the total number of neurons in the adult cortex. Further, the results showed that there was an increase in the proportion of dividing cells in the psuedostratified ventricular epithelium (cell layer lining the lateral ventricles of the telencephalon) or PVE, without have an affect the length of cell cycle. Thus, there was an

increase in the number of divisions of cortical progenitor that resulted in an increase in cortical neurons.

The results of the present study corroborated the findings of the Vaccarino study. There was an increase in brain weight in pups treated with FGF-2 on E15.5, whereas rats that did not receive treatment showed a decrease in brain weight that is likely a result of the incorporation of BrdU. An important aspect in this result was that both the untreated and treated pups had received BrdU. As BrdU has been shown to retard proliferation, the increase in brain weight in the BrdU FGF-2 treated pups suggests that stem cells may be generating new precursor cells.

(a)

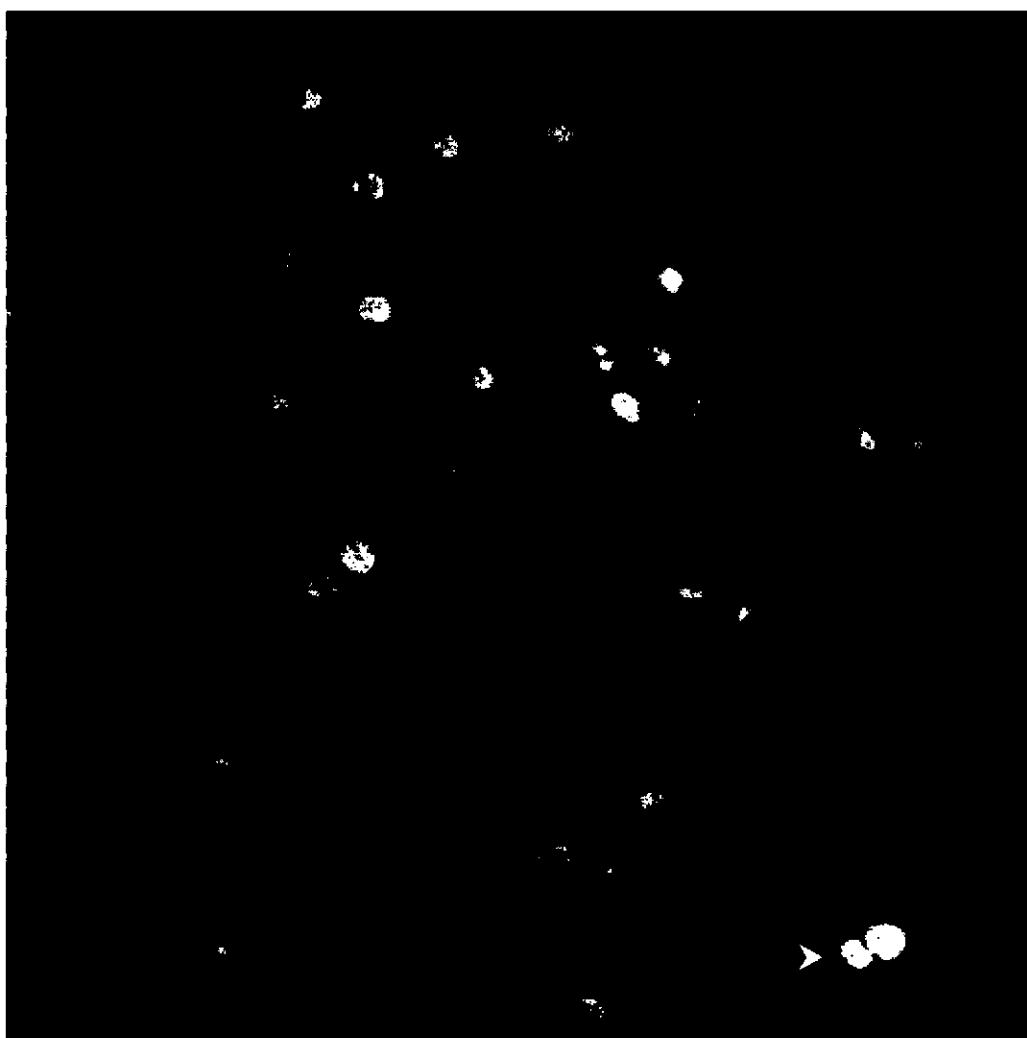



Figure 3.3.3 *Confocal images of PreFGF (a) treated and untreated (b) Layer VI neurons in the anterior cingulate gyrus. ► Indicates double-labeled neuron.*



(a)

Normal (straight) Incisors



(b)

'Dalmation' abdomen

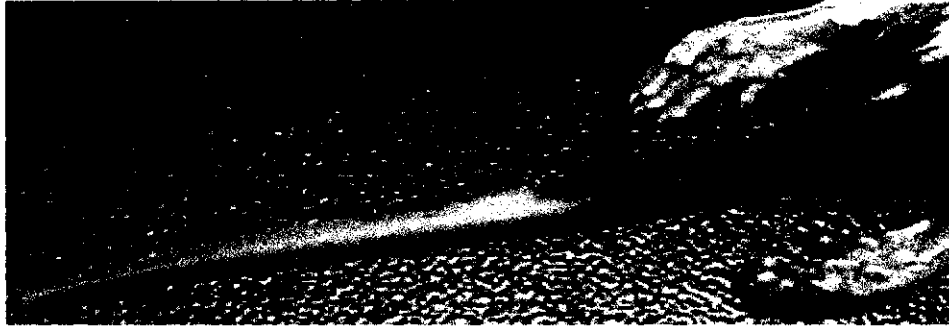

(c)

Straight Tail and Normal (5) toes

Figure 6-5. *The straight incisor teeth (a), dalmation type spots on the abdomen (b), as well as the straight tail and normal number of toes (c) are all typical characteristics of E17 BrdU pups.*